

# MODULAR ELECTRONIC DEVICES

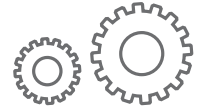

TECHNICAL CATALOGUE

# RELAYS



# ELKO EP



**We are traditional, innovative and purely Czech development manufacturer of electronic devices and we have been your partner in the field of electroinstallations for 27 years.**

ELKO EP employs about 330 people, exports its products to more than seventy countries, and has representatives in fifteen foreign branches. Company of the Year of the Zlín Region, Visionary of the Year, Global Exporter of the Year, Participation in the Czech TOP 100, these are just some of the awards received. Still, we are not finished. We are constantly striving to move forward in the field of innovation and development. That's our primary concern.

Millions of relays, thousands of satisfied customers, hundreds of our own employees, twenty seven years of research, development and production, fifteen foreign branches, one company. ELKO EP, innovative- a purely Czech company based in Holešov, where development, production, logistics, service and support go hand in hand. We primarily focus on developing and manufacturing systems for building automation in the residential, commercial and industrial sector, a wide range of Smart city facilities and the so-called Internet of Things (IoT).



# Facts and stats

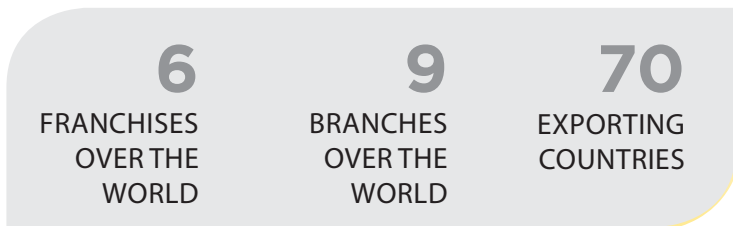
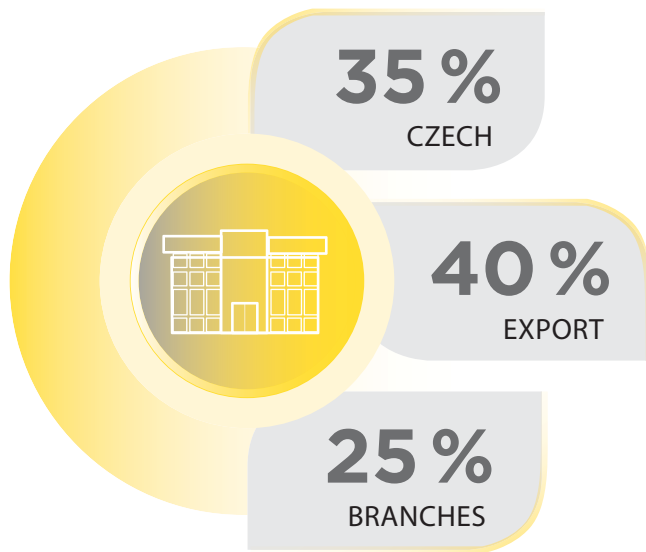

## WE ARE



### DEVELOPERS

In the new R&D center, more than 30 engineers develop new products and extend the functionality of existing products

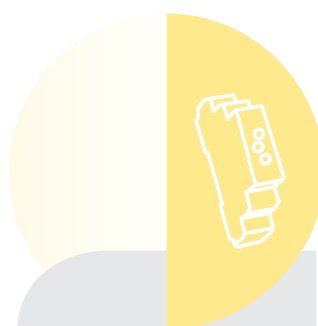

### PRODUCERS

modern antistatic spaces, 2x fully automated SMD production lines, 2 shift operations.



### SUPPORT

24 hours / 7 days / 360 days we not only provide technical support but also logistics.

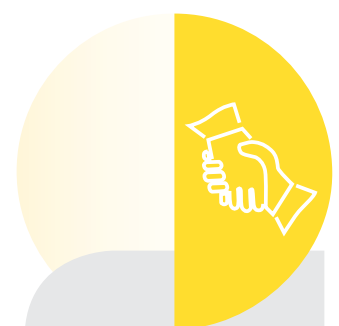

### SELLERS

personal access to more than 70 sales representatives in ELKO EP Holding provides impeccable services and superior products at an affordable price.

# Product Lines ELKO EP

## relay



### Timers/Relays

Time relays, auxiliary relays, installation contactors, bistable relays, staircase switch, time switch clock, dimmers, power supplies, control and signalling devices.

[www.elkoep.com/relays](http://www.elkoep.com/relays)



### Protection and monitoring relays

Voltage relays 1-phase and 3-phase (under voltage, overvoltage, phase failure, phase asymmetry, phase sequence), current relays, power factor and frequency monitoring, thermostats, level relays.

[www.elkoep.com/monitoring](http://www.elkoep.com/monitoring)

## iNELS<sup>®</sup> RF Control



### Wireless electro-installation iNELS RF

Components of smart wireless system can be easily and quickly used in existing buildings where it is not desirable to cut holes for cables (e.g. add/change a light switch when changing room layouts). However, it is also possible to assemble a complete system for apartment or house control, intelligent control of heating, blinds or scene settings. When using the eLAN-RF gateway, the entire installation can also be controlled by an application from a mobile phone, tablet or television.

[www.elkoep.com/wireless](http://www.elkoep.com/wireless)



### Hotel Wireless Retrofit (HRESK)

Hotel Room Energy Saving Kit - is a complete solution designed primarily for existing hotel rooms and is based on the iNELS RF wireless system. It focuses on the following areas: "Energy savings": switching off all appliances when leaving the room or not overheating/not overcooling, "Comfort" - all out of bed and "Safety": bell, guest in the room, maid, visitor.

[www.elkoep.com/retrofit](http://www.elkoep.com/retrofit)

## iNELS<sup>®</sup> BUS System



### Wired electro-installation iNELS BUS

The sensors and actuators, together with the central unit, which is the heart of the system, communicate via a 2-wires and enable the built up a larger installation for family houses, villas, hotels and buildings. Individual functions of elements are parameterized in iDM SW, so simple and more complex actions can be set.

[www.elkoep.com/wired](http://www.elkoep.com/wired)



### Hospitality Hotel (GRMS)

Guest Room Management System – is a comprehensive solution designed primarily for new hotels, guesthouses or wellness and is based on the iNELS BUS system. In the room, it resolves the control of lighting, access, temperature control and audio/video distribution. It features glass panels with touch buttons that can be combined in various ways (numbers, shape, and colours) and customized (description, logo).

[www.elkoep.com/hospitality](http://www.elkoep.com/hospitality)



### Building management system

Building Management System is the supervisor above the iNELS BUS, resp. wireless system iNELS RF. It enables not only the control of several central units (CU) or gateways (eLAN), but also the connection to other protocols that the technology brings in the building (Modbus, Bacnet, KNX, etc.).

[www.elkoep.com/building](http://www.elkoep.com/building)



### Lighting control

iNELS offer a variety of lighting control solutions for all types of light sources: from simple (dimmers from the RELAY range), through wireless (iNELS RF) to sophisticated control within the iNELS BUS installation, which (except conventional R - L - C - LED dimmers) also includes units for light control via DALI and DMX bus.

[www.elkoep.com/lighting](http://www.elkoep.com/lighting)

## LOGUS<sup>90</sup>



### Switches and sockets

Switches, sockets and a complete range of devices and accessories - this is the Logus90 series from the Portuguese manufacturer Efael. This range is complemented by both standard plastic frames and luxury frames made of purely natural materials: real wood, metal, granite or tempered glass. Be exceptional!

[www.elkoep.com/logus90](http://www.elkoep.com/logus90)



## Innovation of single-function time relays CRM-81J and CRM-83J

We have recently added a **rotary switch to set the time range on the front panel**, thus unifying several variants into one type. This allowed us to extend the time range up to a **maximum of 100h** instead of the original **10h**. Functions controlled by the supply voltage connection now have the **possibility to inhibit the ongoing delay** by applying voltage via the control input. Another visible change in this year's news, incl. one-function is the **transition to a new design of 1-MODULE boxes**, which brings easier installation on a DIN rail and higher resistance to vibrations thanks to a reinforced spring on the latch. You can find them under the new type designations **CRM-181J** and **CRM-183J**.

## Staircase switch CRM-4 and CRM-46

Automatic stair switch, are used for delayed switching off of lighting in stairs, corridors and other areas, including the possibility of delayed deceleration of fans, they have undergone innovations, both in terms of vision and parameters. The innovation brings several parameter improvements:

- ♦ increase of the possible **load of the control buttons to 100 mA**
- ♦ signaling of an ongoing delay on the product
- ♦ possibility to **switch off the load before the set delay has elapsed**
- ♦ replacing the slide switch with a rotary switch

The original CRM-42 and CRM-42/F are now replaced by a new product with the type designation **CRM-46**. It combines the functions of the two previous models and also adds two new ones:

- ♦ function of impulse relay and impulse relay with delay



## Timing relays on DIN rail and for PLUG-IN

New types of time relays have an extended time range of **0.05 s - 30 days**.

Available only with universal supply voltage **12 - 240V AC/DC**. Offers innovated **functions** you know from the CRM-91H, including some brand **new ones**.

The relay with multiple output contacts has option to set the **mode of second ev. third contact** thanks to the added rotary potentiometer on the product panel. Relays with only one output contact have the function of **MEMORY LATCH with delay** instead of a output mode. **We divide individual types according to control inputs:**

### On DIN rail:

CRM-111H, CRM-113H - commonly used **voltage-dependent input**, which you know from CRM-91H/93H CRM-121H - **galvanically separated control input**, allowing to control functions by independent external voltage

CRM-131H - **three voltage-dependent inputs** (START, INHIBIT, RESET) for advanced function control



### The socket:

PTRM-216KP and PTRM-216TP - commonly used **voltage-dependent input**, which you know from PRM-91H/92H PTRM-216K and PTRM-216T - **potential-free input**, for control of functions without voltage PTRM-216K and PTRM-216T - **three voltage-dependent inputs** (START, INHIBIT, RESET) for advanced function control.

A knob (**K**) or a potentiometer (**T**) can be selected to fine-tune the delay.



	<b>DESIGN</b>	
<b>TIME RELAYS - MULTIFUNCTION</b>		
CRM-161   Multifunction time relay - <b>economy</b> version (INNOVATION CRM-61)	(1-MODULE)	12
CRM-91H, CRM-93H   Multifunction time relays - <b>BESTSELLER</b>	(1-MODULE)	13
CRM-91HE   Multifunction time relay <b>with external potentiometer</b>	(1-MODULE)	14
<b>NEW</b> CRM-101   Energy-saving time relay	(1-MODULE)	16
<b>NEW</b> CRM-111H, CRM-113H   Multifunction time relay <b>with Inhibit delay</b>	(1-MODULE)	18
<b>NEW</b> CRM-121H   Multifunction time relay <b>with galvanically separated control input</b>	(1-MODULE)	20
<b>NEW</b> CRM-131H   Multifunction time relay <b>with three control inputs</b>	(1-MODULE)	22
CRM-82TO   <b>TRUE OFF DELAY</b> time relay	(1-MODULE)	24
<b>TIME RELAYS - SINGLEFUNCTION, SPECIAL</b>		
CRM-2T   <b>STAR</b> (Λ)/ <b>DELTA</b> (Δ) time relay	(1-MODULE)	25
CRM-181J, CRM-183J   <b>Singlefunction</b> time relays (INNOVATION CRM-81J, CRM-83J)	(1-MODULE)	26
CRM-2H   Asymmetric flasher	(1-MODULE)	28
CRM-2HE   Asymmetric flasher <b>with external potentiometers</b>	(1-MODULE)	29
SJR-2   ON DELAY time relay, 2-channels	(1-MODULE)	30
<b>TIME RELAYS - PLUG-IN</b>		
<b>NEW</b> PTRM-216TP, PTRM-216KP   Multifunction time relay <b>with Inhibit delay</b>	(11-PIN)	31
<b>NEW</b> PTRM-216T, PTRM-216K   Multifunction time relay <b>with potential-free control input</b>	(11-PIN)	32
<b>NEW</b> PTRM-216T, PTRM-216K   Multifunction time relay <b>with three control inputs</b>	(11-PIN)	33
<b>TIME RELAYS - DIGITAL</b>		
CRM-100   Multifunction time relay <b>with LCD display</b>	(1-MODULE)	34
PDR-2/A, PDR-2/B   <b>Programmable</b> digital relays	(3-MODULE)	36
<b>STAIRCASE SWITCHES</b>		
CRM-46   <b>Smart</b> staircase switch (INNOVATION CRM-42, CRM-42F)	(1-MODULE)	38
CRM-4   Staircase switch (INNOVATION)	(1-MODULE)	40
<b>TIME RELAYS - IN THE INSTALLATION BOX</b>		
SMR-K, SMR-T, SMR-H, SMR-B   Super-multifunction time relays	(BOX)	42
<b>TIME SWITCHES</b>		
SHT-1, SHT-1/2, SHT-3, SHT-3/2   <b>Digital</b> time switches <b>with weekly/yearly program</b>	(2-MODULE)	45
SHT-4, SHT-6, SHT-7   <b>Digital</b> time switches - SHT-4 ( <b>astro</b> ), SHT-6 ( <b>with synchronization</b> ), SHT-7 ( <b>NFC</b> )	(2-MODULE)	46
DCFR-1   Receiver DCF 77 for SHT-6 in increased protection	(IP65)	47
<b>NEW</b> ATS-1DR   <b>Analog</b> time switches <b>with daily</b> program	(1-MODULE)	48
<b>NEW</b> ATS-2D, ATS-2DR, ATS-2WR   <b>Analog</b> time switches <b>with daily/weekly</b> program	(2-MODULE)	49
<b>AUXILIARY RELAYS</b>		
VS116B/230, VS116K, VS116U, VS308K, VS308U, VS316/24, VS316/230   Auxiliary relays	(BOX/1-MODULE)	51
<b>INSTALLATION CONTACTORS</b>		
VS120, VS220, VS420, VS425, VS440, VS463   Installation contactors	(1/2/3-MODULE)	55
VSM220, VSM425   Installation contactors <b>with manual control</b>	(1/2-MODULE)	56
<b>MEMORY AND BISTABLE (IMPULSE) RELAYS</b>		
MR-41, MR-42   Memory relays	(1-MODULE)	61
<b>NEW</b> BR-216, BR-220, BR-232   Bistable relays	(1-MODULE)	62
<b>TWILIGHT AND LIGHT SWITCHES</b>		
SOU-1   Twilight switch - <b>analog</b>	(1-MODULE)	64
SOU-2   Twilight and light <b>digital</b> switch <b>with integrated time switch</b>	(2-MODULE)	65
SOU-3   Twilight and light switch <b>with integrated sensor</b> in increased protection	(IP65)	66
<b>POWER SUPPLIES AND BELL TRANSFORMERS</b>		
PSB-10, PS-30-R   Power supplies, switching - stabilized	(BOX/3-MODULE)	69
PS1M, PS2M, PS3M, PS4M   Power supplies, switching - stabilized (INNOVATION PS-10, PS-30, PS-100)	(1/2/3/4-MODULE)	70
ZSR-30, ZNP-10   Power supply, switching - stabilized (ZSR-30), unstabilized (ZNP-10)	(3-MODULE)	72
ZTR-8-8, ZTR-8-12, ZTR-15-12   Bell transformers	(2/3-MODULE)	73
<b>DIMMERS AND LIGHT INTENSITY CONTROLLERS</b>		
DIM-15, SMR-M   Universal dimmers	(1-MODULE/BOX)	76
DIM-2   Dimmer <b>with stair case switch function</b>	(1-MODULE)	78
SMR-S   Controlled dimmer	(BOX)	79
DIM-6   Controlled universal dimmer	(6-MODULE)	80
DIM6-3M-P   Expandable power module for dimmer DIM-6	(3-MODULE)	81
LIC-1   Light intensity controller <b>with direct output</b> R-L-C-ESL-LED	(1-MODULE)	82
LIC-2   Light intensity controller <b>with analog output</b> 0(1) - 10V	(1-MODULE)	83
RFDEL-76M   Universal dimmer, 6-channels	(6-MODULE)	84
<b>CONTROLLING AND SIGNALLING MODULES</b>		
USS   Controlling and signalling modules	(1-MODULE)	86

	<b>DESIGN</b>	
<b>VOLTAGE 1 PHASE</b>		
HRN-33, HRN-63, HRN-35, HRN-37, HRN-67   Voltage monitoring relays <b>in 1P - AC</b> .....	(1-MODULE)	90
HRN-34, HRN-64   Voltage monitoring relays <b>in 1P - DC</b> .....	(1-MODULE)	90
HRN-41, HRN-42   Voltage monitoring relays <b>in 1P - AC/DC</b> .....	(3-MODULE)	92
<b>VOLTAGE 3 PHASES</b>		
HRN-55, HRN-55N   Voltage monitoring relays <b>in 3P with fixed levels</b> .....	(1-MODULE)	94
HRN-57, HRN-57N   Voltage monitoring relays <b>in 3P with adjustable levels</b> .....	(1-MODULE)	95
HRN-54, HRN-54N   Voltage monitoring relays <b>in 3P with adjustable levels</b> .....	(1-MODULE)	96
HRN-56   Voltage monitoring relay <b>in 3P with adjustable level Umin</b> .....	(1/3-MODULE)	97
HRN-43, HRN-43N   Voltage monitoring relay for complete control <b>in 3P incl. asymmetry</b> .....	(3-MODULE)	98
 HRN-100,   Multifunction voltage monitoring relay <b>in 3P with LCD display</b> .....	(2-MODULE)	100
<b>SPECIAL</b>		
MPS-1   <b>Light indicator</b> of voltage in 3P .....	(1-MODULE)	103
COS-2   <b>Power factor (cos φ)</b> monitoring relay .....	(3-MODULE)	104
HRF-10   <b>Frequency (f)</b> monitoring relay .....	(3-MODULE)	106
<b>CURRENT</b>		
PRI-32   Current monitoring relay of <b>I<sub>max</sub> level passing through a hole in 1P - AC</b> .....	(1-MODULE)	108
PRI-50   Current monitoring relay of <b>I<sub>min</sub> level in 1P - AC</b> .....	(1-MODULE)	109
PRI-51   Current monitoring relay of <b>I<sub>max</sub> level in 1P - AC</b> .....	(1-MODULE)	110
PRI-52   Current monitoring relay of <b>I<sub>max</sub> level passing through a hole in 1P - AC</b> .....	(1-MODULE)	111
PRI-53   Current monitoring relay of <b>I<sub>min</sub> or I<sub>max</sub> in 3P</b> .....	(6-MODULE)	112
PRI-41, PRI-42   Current monitoring relay of <b>I<sub>min</sub> and I<sub>max</sub> in 1P - AC/DC</b> .....	(3-MODULE)	113
<b>LEVEL</b>		
HRH-5   Level switch for monitoring 1 or 2 levels .....	(1-MODULE)	115
HRH-7   Level switch for monitoring 1 or 2 levels <b>in increased protection</b> .....	(IP65)	116
HRH-8   Multifunction level switch for monitoring 1 or 2 levels .....	(3-MODULE)	118
 HRH-9   Universal level switch <b>for monitoring 1 to 6 levels</b> .....	(6-MODULE)	120
HRH-6   Level switch <b>for monitoring 5 levels in increased protection</b> .....	(IP65)	122
HRH-4   Set of level switch HRH-5 and contactor VS-425 .....	(IP65)	124
HRH-x   Set of level switch HRH-5, contactor VS-425 and motor starter MS18 .....	(IP65)	125
<b>ACCESSORIES FOR LEVEL SWITCHES</b>		
SHR   Level probes .....		126
D03VV-F, D05V-K   Cables and wires .....		127
<b>THERMOSTATS</b>		
TER-3A, TER-3B, TER-3C, TER-3D, TER-3G, TER-3H   Single-level thermostats <b>with ranges from -30 to +70 °C</b> .....	(1-MODULE)	131
TER-3E, TER-3F   Single-level thermostats <b>with ranges from 0 to +60 °C</b> .....	(1-MODULE)	132
TER-7   Thermostat for monitoring <b>temperature of motor winding</b> .....	(1-MODULE)	133
TER-4   <b>Double</b> thermostat <b>with a range of -40 to +110 °C</b> .....	(3-MODULE)	134
TER-9   Digital thermostat <b>with integrated time switch</b> .....	(2-MODULE)	136
TEV-1   Two-level thermostat <b>with a range of -20 to +20 °C</b> in increased protection .....	(IP65)	138
TEV-2, TEV-3   Single-level thermostats <b>with a range of -20 to +35 °C</b> in increased protection .....	(IP65)	139
TEV-4   Single-level thermostat <b>with ranges -30 to +60 °C</b> in increased protection .....	(IP65)	140
<b>HYGROSTATS</b>		
RHT-1   RHT-1   Hygrothermostat <b>with temperature range 0 to +60 °C and humidity 50 to 90%</b> .....	(1-MODULE)	141
RHV-1   Hygrostat <b>with humidity range 0 to 90%</b> in increased protection .....	(IP65)	142
<b>THERMOSTAT ACCESSORIES</b>		
ATV-1   Energy-saving digital thermo-valve .....		143
TELVA-2 230 V, TELVA-2 24V   Thermodriver TELVA .....		144
TC, TZ, Pt100   Temperature sensors .....		145
<b>TECHNICAL DETAILS</b>		
Training, technical support .....		146
Guiding principles for the correct use of products .....		147
Load capacity of products .....		148
Product packaging .....		150
Dimensions .....		151
Examples of use .....		158

## Multifunction

**CRM-161**

6 functions, 6 time range 1x 8 A switch, power supply AC 24-240 V, DC 24 V, economic variant CRM-91H. page 12

**CRM-91H**

10 functions, 10 time ranges, 1x output 16 A changeover/SPDT, multivoltage or 230 V supply. page 13

**CRM-93H**

As CRM-91H but output 3x 8 A changeover/SPDT. page 13

**CRM-91HE**

As CRM-91H but with time setting by external potentiometer (for frequent setting). page 14

**CRM-101**

Relay for the automatic switching on and off of electricity in rooms, using connected sensors (motion detector and magnetic door contact). page 16

**CRM-111H**

11 functions 10 time ranges, output contact: 1x switch 16 A. page 18

**CRM-113H**

10 functions, 10 time ranges, output contact: 1x 16 A + 2x 8 A switches, relay mode selection. page 18

**CRM-121H**

As CRM-111H, but with galvanically separated input. page 20

**CRM-131H**

11 functions, 10 time ranges, output contact: 1x switch 16 A, three control inputs. page 22

**CRM-82TO**

"True OFF" relay - delay off without supply, for backup circuits. page 24

## Singlefunction, special

**CRM-2T**

Star/delta timer relay page 25

**CRM-181J**

Variants of 4 functions with time range 0.1s - 100 h, output 1x 16 A switch., UNI power supply. page 26

**CRM-183J**

As CRM-181J, but output 1x16A + 2x 8 A switch. page 26

**CRM-2H**

Asymmetric cycler, independent time setting ON/OFF. page 28

**CRM-2HE**

As CRM-2H, but time setting by external potentiometers (for frequent setting). page 29

**SJR-2**

2x delay on, gradual switching of high loads. page 30

## PLUG-IN

**PTRM-216TP**

10 functions, 10 time ranges, output contact: 2x switches 16 A, voltage dependent input, mode selection of output contact, tuning with dials. page 31

**PTRM-216KP**

As PTRM-216TP, but fine tuning using a knob. page 31

**PTRM-216T**

10 functions, 10 time ranges, output contact: 2x changeover 16 A, potential-free input, mode selection of output contact, dial tuning. page 32

**PTRM-216K**

As PTRM-216T, but fine tuning using a knob. page 32

**PTRA-216T**

10 function, 10 time ranges, output contact 2x switches 16 A, three control inputs and mode selection of output contact, tuning with dials. page 33

**PTRA-216K**

As PTRA-216T, but fine tuning help with a knob. page 33



Digital



**CRM-100**

17 functions, time range 0.1 s- 999 hours, 1x 8 A changeover contact, power supply 24-240 V AC/DC. page 34



**PDR-2A**

4 digit display, 16 functions, 2 independent times 0.01s-100 hrs, 2 outputs 16 A changeover/SPDT START/STOP inputs. page 36



**PDR-2B**

As PDR-2A but 10 functions for each output and time - meaning two relays in one device. page 36

Staircase switches



**CRM-46**

Time 0.5 - 10 min, automatic with the possibility of warning before switching off and extending the set delay by the number of button presses. page 38



**CRM-4**

Basic version , time 0.5-10 min, output contact 16 A, anti-blocking function. page 40



**DIM-2**

With dimming, setting: dim-up/shining/dim-down brightness only for el. bulbs output up to 500 VA. page 78

In the installation box



**SMR-K**

Super multifunction relay for installation into an installation box, 3 wire connection (without neutral). Input: can be connected in parallel with LED energy saving light bulb or fluorescent lamp. page 42



**SMR-T**

Super multifunction relay for installation into a wiring box, 3 wire connection (without neutral). page 42



**SMR-H**

As SMR-T but 4 wire connection, output - triac 0-200 VA, 9 functions including function of memory relay. page 42



**SMR-B**

As SMR-H but output relay contact 16 A (possibility to switch also fluorescent lights and LED). page 42

Accessories

CRM-91HE, 2HE



**Potentiometer**

Potentiometer - external control unit for CRM-2HE and CRM-91HE, mounting into a switchboard, max. connection length 10 m. (32.8 ft.). EAN code: 8595188125215

PLUG-IN

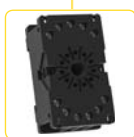

**Socket ES11**

11-PIN octal socket Max. Current: 10 A Weight: 60 g (2.1 oz.) Mounting on DIN rail. EAN code: 8595188129879

1-MODULE



**Comb busbar CB-17-8**

Serves for mass connection of up to eight power supply contacts A1 and A2, it is suitable for all relays with awidth of 17.5 mm (0.69") (1-module) Pack of 10 pcs. EAN code: 8598188181892

	CRM-161	CRM-91H	CRM-93H	CRM-91HE	CRM-111H	CRM-113H	CRM-121H	CRM-131H	CRM-82TO	CRM-2T	CRM-181J ZR	CRM-181J ZN	CRM-181J BL	CRM-181J OD	CRM-183J ZR	CRM-183J ZN	CRM-183J BL	CRM-183J OD	CRM-2H	CRM-2HE	SJR-2	PTRM-216TP	PTRM-216KP	PTRM-216T	PTRM-216T	PTRM-216K	PTRA-216T	PTRA-216K	CRM-100	PDR-2/A	PDR-2/B	CRM-4	CRM-46	SMR-K	SMR-T	SMR-H	SMR-B			
<b>Design</b>																																								
1-MODULE	•	•	•	•	•	•	•	•	•	•	•	•	•	•	•	•	•	•	•	•	•	•								•				•	•					
3-MODULE																																	•	•						
PLUG-IN																							•	•	•	•	•	•	•											
Under the switch																																				•	•	•	•	
<b>Controls</b>																																								
Rotary switches/potentiometers	•	•	•	•	•	•	•	•	•	•	•	•	•	•	•	•	•	•	•	•	•	•	•	•	•	•	•	•							•	•	•	•	•	
Big knob																								•			•		•											
Button																																								
External potentiometer				•																																				
<b>Time</b>																																								
50 ms – 0.5 s					•	•	•	•																•	•	•	•	•	•											
0.1 – 1 s	•	•	•	•	•	•	•	•	•	•	•	•	•	•	•	•	•	•	•	•	•	•	•	•	•	•	•	•	•								•	•	•	•
1 – 10 s	•	•	•	•	•	•	•	•	•	•	•	•	•	•	•	•	•	•	•	•	•	•	•	•	•	•	•	•	•								•	•	•	•
0.1 – 1 min	•	•	•	•	•	•	•	•	•	•	•	•	•	•	•	•	•	•	•	•	•	•	•	•	•	•	•	•	•								•	•	•	•
1 – 10 min	•	•	•	•	•	•	•	•	•	•	•	•	•	•	•	•	•	•	•	•	•	•	•	•	•	•	•	•	•								•	•	•	•
0.1 – 1 hr	•	•	•	•	•	•	•	•		•	•	•	•	•	•	•	•	•	•	•	•	•	•	•	•	•	•	•	•								•	•	•	•
1 – 10 hrs	•	•	•	•	•	•	•	•		•										•	•	•	•	•	•	•	•	•	•								•	•	•	•
0.1 – 1 day		•	•	•	•	•	•	•		•										•	•	•	•	•	•	•	•	•	•								•	•	•	•
1 – 10 days					•	•	•	•		•											•	•	•	•	•	•	•	•	•								•	•	•	•
3 – 30 days					•	•	•	•		•											•	•	•	•	•	•	•	•	•											
10 – 100 days									•												•	•																		
0.5 – 10 min																																						•	•	
99 hrs 59 min 59 s																																							•	•
0.1s – 999 hrs																																							•	•
<b>Supply voltage</b>																																								
AC 230 V		•	•							•											•	•														•	•	•	•	•
AC/DC 12–240 V		•	•	•	•	•	•	•	•	•		•	•	•	•	•	•	•	•	•	•	•	•	•	•	•	•	•	•								•	•		
AC 24–240 V, DC 24 V	•																																							
AC/DC 24–240 V																																							•	
<b>Output</b>																																								
1x changeover 8 A	•																																					•		
1x changeover 16 A		•	•	•	•	•	•				•	•	•							•	•																•			
2x changeover 8 A									•		•																													
2x changeover 16 A										•													•	•	•	•	•	•	•	•								•		
1x switching 16 A																																						•		•
1x changeover 16 A, 2x changeover 8 A			•		•										•	•	•	•																						
Contactless (triac)																																						•	•	•

	CRM-161	CRM-91H	CRM-93H	CRM-91HE	CRM-111H	CRM-113H	CRM-121H	CRM-131H	CRM-82TO	CRM-2T	CRM-181J ZR	CRM-181J ZN	CRM-181J BL	CRM-181J OD	CRM-183J ZR	CRM-183J ZN	CRM-183J BL	CRM-183J OD	CRM-2H	CRM-2HE	SJR-2	PTRM-216x	PTRM-216xP	PTRM-216x	CRM-100	PDR-2/A	PDR-2/B	CRM-4	CRM-46	SMR-K	SMR-T	SMR-H	SMR-B							
<b>Functions</b>																																								
Staircase switch																																								
Programmable stair controller with/ without signaling																																								
Delayed start	●	●	●	●	●	●	●	X			●			●									●	●	X	●	■	●												
Delayed start with delay suppression					●	●	●				●			●										●	●		●	■												
Delayed start after switching on the control contact	●																										●	■	●					●	●	●	●			
Delayed start after opening of the control contact																											●	■	●											
Delayed start after closing and delayed return after opening the control contact		●	●	●	●	●	●	X																●	●	X	●	■					●	●	●	●				
Delayed start star / triangle										●																		■												
2x delayed start																							●																	
Delayed return	●	●	●	●	●	●	●	X			●			●										●	●	X	●	■	●											
Delayed return with delay suppression					●	●	●				●			●										●	●		●	■												
Delay off on downward edge																																			●	●	●	●		
Delayed return after power off									●																															
Delayed return after closing the control contact		●	●	●	●	●	●	X																●	●	X	●	■	●											
Delayed return after opening the control contact		●	●	●																							●	■	●						●	●	●	●		
Delayed return after opening the control contact with immediate closing of the output	●	●	●	●	●	●	●						●					●						●	●	X	●	■	●				●	●	●	●				
Delayed return after closing the control contact - renewable					●	●	●	X																●	●	X														
Delayed return after closing and opening of the control contact					●	●	●	X																●	●	X	●	■												
Delayed return when closing the control contact with delayed output																												■	●											
Blink 1: 1 starting pulse.	●	●	●	●	●	●	●	X			●			●									●	●	X	■	●													
Blink1: 1 starting pulse suppression delay												●			●																									
Blink1: 1 starting with a pulse in the form of pressing the control button																																				●	●	●	●	
Blink 1: 1 starting with a space		●	●	●	●	●	●	X																●	●	X	■	●												
Blink 1: 1 starting with a space while the control button is pressed																																					●	●	●	●
Asymmetric blink starting with a pulse																				●	●					●	■													
Asymmetric blink starting with a space																				●	●					●	■													
Impulse relay		●	●	●	●	●	●																	●	●								●	●	●	●	●	●		
Impulse relay with delay	●				●	●	●	X																											●	●	●	●		
Pulse generator 0.5 s		●	●	●	●	●	●	X																●	●	X		■												
Pulse generator with delay suppression					●	●	●																	●	●															

x functions controlled by inputs START, INHIBIT, RESET  
 ■ functions controlled by inputs START, STOP



EAN code  
CRM-161: 8595188181617

Technical parameters		CRM-161
<b>Power supply</b>		
Supply terminals:	A1 - A2	
Voltage range:	AC 24 - 240 V (AC 50/60 Hz) and DC 24 V	
Power input (max.):	2 VA/1.5 W	
Supply voltage tolerance:	-15 %; +10 %	
Supply indication:	green LED	
<b>Time circuit</b>		
Number of functions:	6	
Time ranges:	0.1 s - 10 hrs	
Time setting:	rotary switch and potentiometer	
Time deviation:	5 % - mechanical setting	
Repeat accuracy:	0.2 % - set value stability	
Temperature coefficient:	0.01 %/°C, at = 20 °C (0.01 %/°F, at = 68 °F)	
<b>Output</b>		
Number of contacts:	1x changeover/SPDT (AgNi)	
Current rating:	8 A/AC1	
Breaking capacity:	2000 VA/AC1, 192 W/DC	
Switching voltage:	250V AC/24V DC	
Max. power dissipation:	0.6 W	
Output indication:	multifunction red LED	
Mechanical life:	10.000.000 operations	
Electrical life (AC1):	50.000 operations	
<b>Control</b>		
Control. terminals:	A1-S	
Load between S-A2:	Yes	
Impulse length:	min. 25 ms/max. unlimited	
Reset time:	max. 150 ms	
<b>Other information</b>		
Operating temperature:	-20 °C to +55 °C (-4 °F to 131 °F)	
Storage temperature:	-30 °C to +70 °C (-22 °F to 158 °F)	
Dielectrical strength:	4kV AC (supply - output)	
Operating position:	any	
Mounting:	DIN rail EN 60715	
Protection degree:	IP40 from front panel/IP20 terminals	
Overvoltage category:	III.	
Pollution degree:	2	
Max. cable size (mm <sup>2</sup> ):	solid wire max. 1x 2.5 or 2x 1.5/ with sleeve max. 1x 2.5 (AWG 12)	
Dimensions:	90 x 17.6 x 64 mm (3.5" x 0.7" x 2.5")	
Weight:	62 g (2.2 oz.)	
Standards:	EN 61812-1	

- Multifunction economy version of time relay for universal use in automation, control and regulation or in house installations.
- Universal supply voltage: AC 24 – 240 V (AC 50/60 Hz) and DC 24V.
- Comfortable and well-arranged function and time-range setting by rotary switches.
- Time scale 0.1 s - 10 hrs divided into 6 ranges: (0.1 s - 1 s/1 s - 10 s/0.1 min - 1 min/1 min - 10 min/0.1 hrs - 1 h/1 h - 10 hrs).
- Output contact: 1x changeover/SPDT 8 A.
- Multifunction red LED flashes or shines depending on the operating status.

## Description

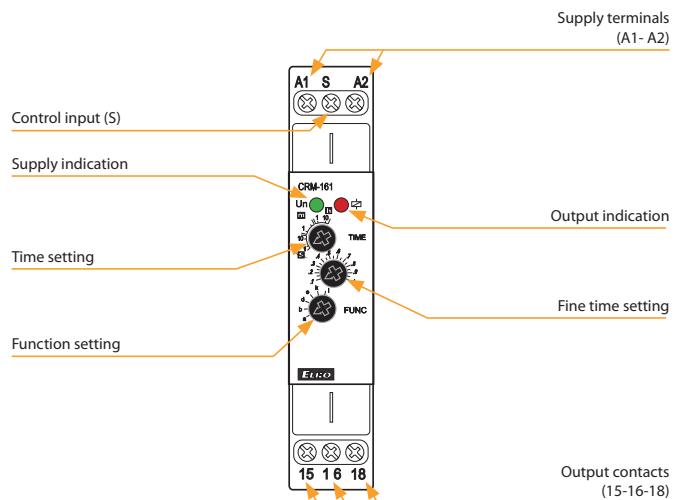

## Functions

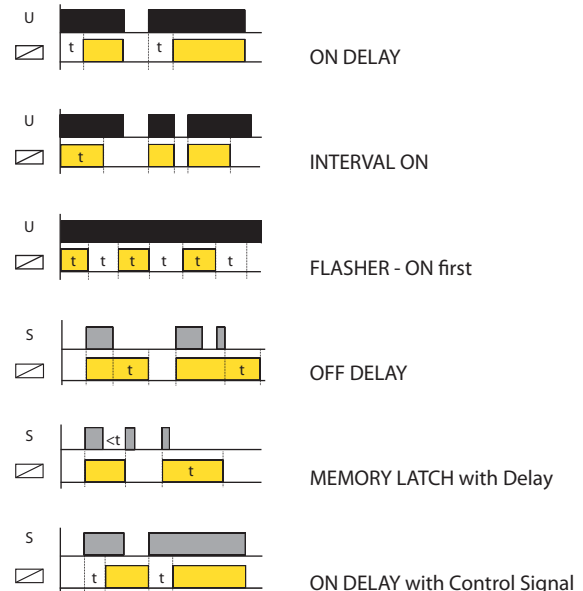

## Connection

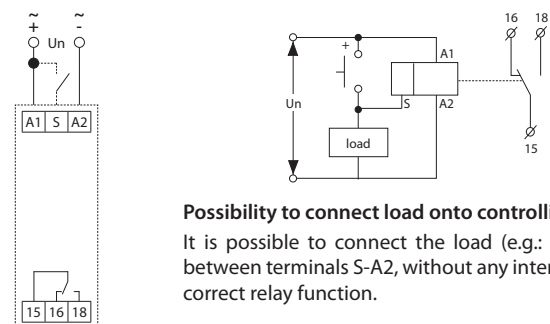

**Possibility to connect load onto controlling input**  
It is possible to connect the load (e.g.: contactor) between terminals S-A2, without any interruption of correct relay function.

## Indication of operating states

### Examples of signaling

#### Function a

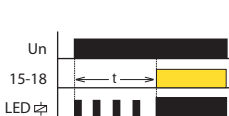

#### Function e

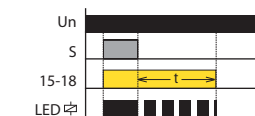



EAN code  
 CRM-91H/230V: 8595188112444  
 CRM-91H/UNI: 8595188112420  
 CRM-93H/230V: 8595188112789  
 CRM-93H/UNI: 8595188112468

Technical parameters	CRM-91H	CRM-93H
<b>Power supply</b>		
Supply terminals:	A1 - A2	
Voltage range:	AC/DC 12 - 240 V (AC 50/60 Hz)	
Power input (max.):	2 VA/1.5 W	2.5 VA/1.5 W
Voltage range:	AC 230 V (50/60 Hz)	
Power input (max.):	AC 3VA/1.4W	AC 4VA/2W
Supply voltage tolerance:	-15 %; +10 %	
Supply indication:	green LED	
<b>Time circuit</b>		
Number of functions:	10	
Time ranges:	0.1 s - 10 days	
Time setting:	rotary switch and potentiometer	
Time deviation:	5 % - mechanical setting	
Repeat accuracy:	0.2 % - set value stability	
Temperature coefficient:	0.01 %/°C, at = 20 °C (0.01 %/°F, at = 68 °F)	
<b>Output</b>		
Number of contacts 1:	1x changeover/SPDT (AgNi)	
Current rating:	16 A/AC1	
Breaking capacity:	4000 VA/AC1, 384 W/DC	
Electrical life (AC1):	50.000 operations	
Number of contacts 2 (3):	x	2x chang./DPDT (AgNi)
Current rating:	x	8 A/AC1
Breaking capacity:	x	2000 VA/AC1, 192 W/DC
Electrical life (AC1):	x	10.000 operations
Switching voltage:	250V AC/24V DC	
Max. power dissipation:	1.2 W	2.4 W
Output indication:	multifunction red LED	
Mechanical life:	10.000.000 operations	
<b>Control</b>		
Control. terminals:	A1-S	
Load between S-A2:	Yes	
Impulse length:	min. 25 ms/max. unlimited	
Reset time:	max. 150 ms	
<b>Other information</b>		
Operating temperature:	-20 °C to +55 °C (-4 °F to 131 °F)	
Storage temperature:	-30 °C to +70 °C (-22 °F to 158 °F)	
Dielectrical strength:		
supply - output 1	4kV AC	
supply - output 2 (3)	x	1kV AC
output 1 - output 2	x	1kV AC
output 2 - output 3	x	1kV AC
Operating position:	any	
Mounting:	DIN rail EN 60715	
Protection degree:	IP40 from front panel/IP20 terminals	
Overvoltage category:	III.	
Pollution degree:	2	
Max. cable size (mm <sup>2</sup> ):	solid wire max. 1x 2.5 or 2x 1.5/ with sleeve max. 1x 2.5 (AWG 12)	
Dimensions:	90 x 17.6 x 64 mm (3.5" x 0.7" x 2.5")	
Weight:	UNI - 62 g (2.2 oz.); 230 - 57 g (2 oz.)	UNI - 85 g (3oz.); 230 - 80 g (2.8 oz.)
Standards:	EN 61812-1	

- Multifunction time relay for universal use in automation, control and regulation or in house installations.
- Comfortable and well-arranged function and time-range setting by rotary switches.
- Multifunction red LED flashes or shines depending on the operating status.

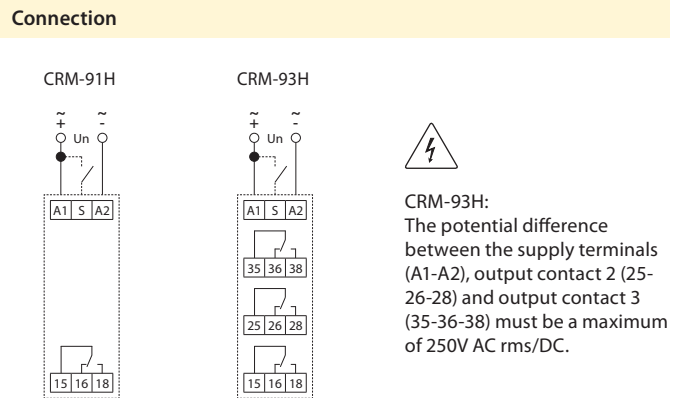
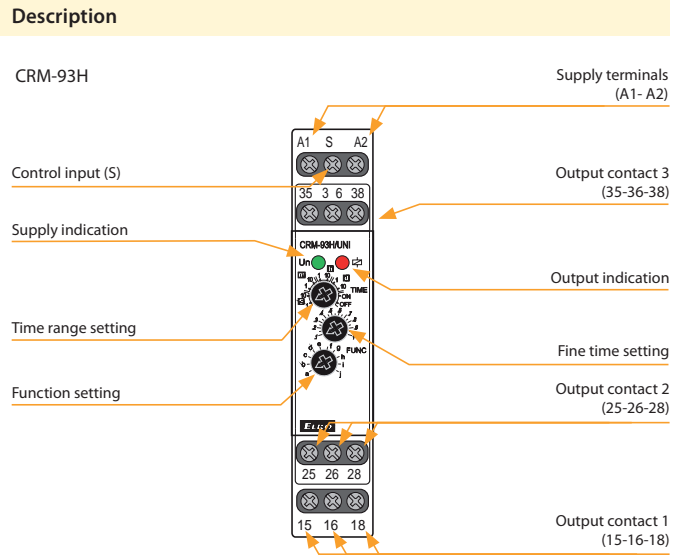

**Possibility to connect load onto controlling input**  
 It is possible to connect the load (e.g.: contactor) between terminals S-A2, without any interruption of correct relay function.

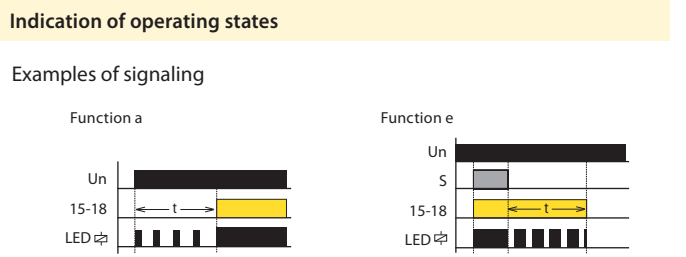
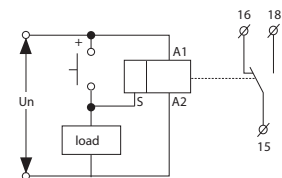

**Function**  
 Function (page 15).



EAN code  
CRM-91HE /UNI + potentiometr: 8595188142052  
Potentiometr: 8595188125215

Technical parameters	CRM-91HE
Number of functions:	10
Supply terminals:	A1 - A2
Voltage range:	AC/DC 12 - 240 V (AC 50/60 Hz)
Burden (max.):	AC 0.7 - 3 VA/DC 0.5 - 1.7 W
Max. dissipated power:	4 W (Un + terminals)
Supply voltage tolerance:	-15 %; +10 %
Supply indication:	green LED
Time ranges:	0.1 s - 10 days
Time setting:	rotary switch, external potentiometer
Time deviation:	5% - mechanical setting
Repeat accuracy:	0.2 % - set value stability
Temperature coefficient:	0.01 %/°C, at = 20°C (0.01%/°F, at = 68°F)

Output	
Number of contacts:	1x changeover/SPDT (AgNi/Silver Alloy)
Current rating:	16 A/AC1
Breaking capacity:	4000 VA/AC1, 384 W/DC
Inrush current:	30 A/<3 s
Switching voltage:	250V AC/24V DC
Output indication:	multifunction red LED
Mechanical life:	30.000.000 operations
Electrical life (AC1):	70.000 operations

Controlling	
Control. voltage:	AC/DC 12 - 240 V (AC 50/60 Hz)
Consumption of input:	AC 0.025-0.2 VA/DC 0.1-0.7 W
Load between S-A2:	Yes
Glow-tubes:	No
Control. terminals:	A1-S
Impulse length:	min. 25 ms/max. unlimited
Reset time:	max. 150 ms

Other information	
Operating temperature:	-20 °C to +55 °C (-4 °F to 131 °F)
Storage temperature:	-30 °C to +70 °C (-22 °F to 158 °F)
Electrical strength:	4 kV (supply - output)
Operating position:	any
Mounting:	DIN rail EN 60715
Protection degree:	IP40 from front panel/IP20 terminals
Overvoltage category:	III.
Pollution degree:	2
Max. cable size (mm <sup>2</sup> ):	solid wire max. 1x 2.5 or 2x 1.5/ with sleeve max. 1x 2.5 (AWG 12)
Dimensions:	90 x 17.6 x 64 mm (3.5" x 0.7" x 2.5")
Weight:	75 g (2.6 oz.)
Standards:	EN 61812-1

Technical parameters	Potentiometer
Potentiometer:	47 kΩ, linear
Protection degree:	IP 65 from front side/IP20 from back side
Max. cable size (mm <sup>2</sup> ):	1.5 with sleeve/without sleeve max. 2.5 (AWG 12)
Weight:	22 g (0.8 oz.)
Dimensions:	see page Accessories

- Control by external control unit - potentiometer (can be placed/mounted for example on switch board doors or in panel).
- 10 functions :
  - 5 time functions controlled by supply voltage
  - 4 time functions controlled by control input
  - 1 function of latching relay.
- Possible to connect external potentiometer - max. distance 10 m (32.8 ft.) from relay

## Description

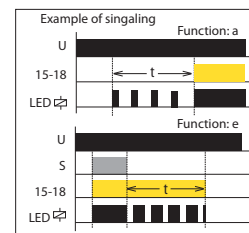
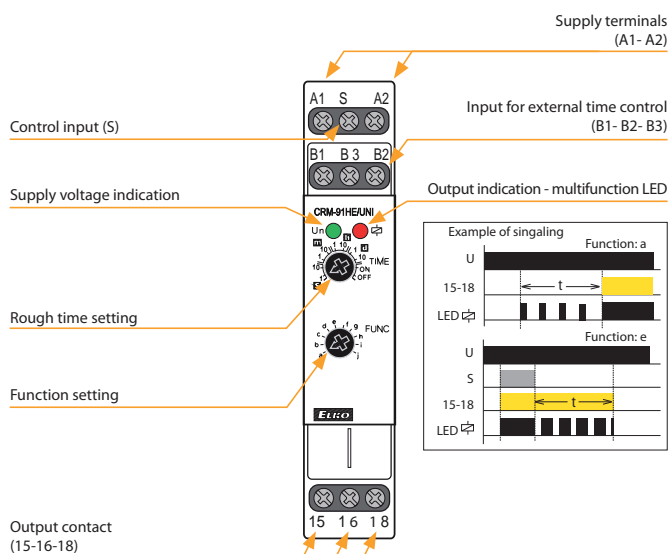

## Connection

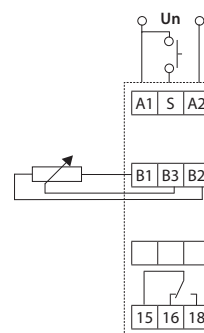

## Symbol

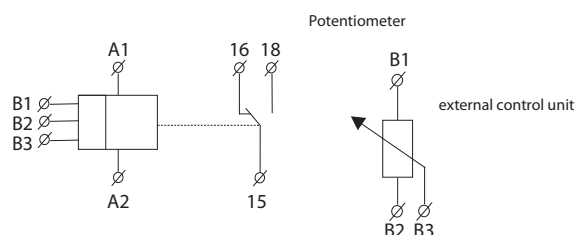

## Function

For a description of the functions on page 15

Function



**ON DELAY**  
When the input voltage U is applied, timing delay t begins. Relay contacts R change state after time delay is complete. Contacts R return to their shelf state when input voltage U is removed. Trigger switch is not used in this function.



**INTERVAL ON**  
When input voltage U is applied, relay contacts R change state immediately and timing cycle begins. When time delay is complete, contacts return to shelf state. When input voltage U is removed, contacts will also return to their shelfstate. Trigger switch is not used in this function.



**FLASHER - OFF first**  
When input voltage U is applied, time delay t begins. When time delay t is complete, relay contacts R change state for time delay t. This cycle will repeat until input voltage U is removed. Trigger switch is not used in this function.



**FLASHER - ON first**  
When input voltage U is applied, relay contacts R change state immediately and time delay t begins. When time delay t is complete, contacts return to their shelf state for time delay t. This cycle will repeat until input voltage U is removed. Trigger switch is not used in this function.



**OFF DELAY**  
Input voltage U must be applied continuously. When trigger switch S is closed, relay contacts R change state. When trigger switch S is opened, delay t begins. When delay t is complete, contacts R return to their shelf state. If trigger switch S is closed before time delay t is complete, then time is reset. When trigger switch S is opened, the delay begins again, and relay contacts R remain in their energized state. If input voltage U is removed, relay contacts R return to their shelf state.

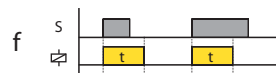

**SINGLE SHOT**  
Upon application of input voltage U, the relay is ready to accept trigger signal S. Upon application of the trigger signal S, the relay contacts R transfer and the preset time t begins. During time-out, the trigger signal S is ignored. The relay resets by applying the trigger switch S when the relay is not energized.

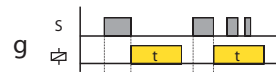

**SINGLE SHOT falling edge**  
Upon application of input voltage U, the relay is ready to accept trigger signal S. Upon application of the trigger signal S, the relay contacts R transfer and the preset time t begins. At the end of the preset time t, the relay contacts R return to their normal condition unless the trigger switch S is opened and closed prior to time out t (before preset time elapses). Continuous cycling of the trigger switch S at a rate faster than the preset time will cause the relay contacts R to remain closed. If input voltage U is removed, relay contacts R return to their shelf state.

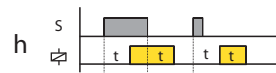

**ON/OFF DELAY**  
Input voltage U must be applied continuously. When trigger switch S is closed, time delay t begins. When time delay t is complete, relay contacts R change state and remain transferred until trigger switch S is opened. If input voltage U is removed, relay contacts R return to their shelf state.

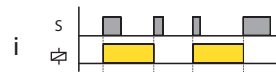

**MEMORY LATCH**  
Input voltage U must be applied continuously. Output changes state with every trigger switch S closure. If input voltage U is removed, relay contacts R return to their shelf state.

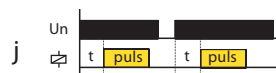

**PULSE GENERATOR 0.5 s**  
Upon application of input voltage U, a single output pulse of 0.5 seconds is delivered to relay after time delay t. Power must be removed and reapplied to repeat pulse. Trigger switch is not used in this function.

NEW



EAN code  
CRM-101/UNI: 8595188181327

### Technical parameters

### CRM-101

#### Power supply

Supply terminals:	A1 - A2
Voltage range:	AC/DC 12 - 240 V (AC 50/60 Hz)
Power input (max.):	2 VA/1.5W
Supply voltage tolerance:	-15 %; +10 %
Supply indication:	green LED

#### Time circuit

Time range t1:	1 - 60 min (t1 = t1a + t1b)
Time range t2:	0.5 - 10s
Time setting:	rotary switch and potentiometer
Time deviation:	5 % - mechanical setting
Repeat accuracy:	0.2 % - set value stability
Temperature coefficient:	0.01 %/°C, at = 20 °C (0.01 %/°F, at = 68 °F)

#### Output

Number of contacts:	1x changeover/SPDT (AgNi)
Current rating:	16A/AC1
Breaking capacity:	4000VA/AC1, 384W / DC
Switching voltage:	250V AC/24V DC
Max. power dissipation:	1.2 W
Output indication:	multifunction red LED
Mechanical life:	10.000.000 operations
Electrical life (AC1):	50.000 operations

#### Control

Control terminals:	IN1-IN1, IN2-IN2
Impulse length:	min. 25 ms/max. unlimited
Reset time:	max. 150 ms

#### Other information

Operating temperature:	-20 °C to +55 °C (-4 °F to 131 °F)
Storage temperature:	-30 °C to +70 °C (-22 °F to 158 °F)
Dielectrical strength:	4kV AC (supply - output)
Operating position:	any
Mounting:	DIN rail EN 60715
Protection degree:	IP40 from front panel/IP20 terminals
Overvoltage category:	III.
Pollution degree:	2
Max. cable size (mm <sup>2</sup> ):	solid wire max. 1x 2.5 or 2x 1.5/ with sleeve max. 1x 2.5 (AWG 12)
Dimensions:	90 x 17.6 x 64 mm (3.5" x 0.7" x 2.5")
Weight:	70 g (2.5 oz.)
Standards:	EN 61812-1

- Time relay for automatic switching ON and OFF of electricity in hotel rooms, with the help of connected sensors (replacement of common card switches).
- 2 control inputs - **potential-free contacts**:  
IN1 (MD) - motion detector  
IN2 (MC) - magnetic door contact
- Adjustable configuration of control inputs:  
NO - normally open/NC - normally closed, according to the type of connected sensors).
- Time delay t1 (delayed switch-off of electricity).  
Adjustable in the range of 1 - 60 min in minute steps.
- Time delay t2 (input blocking for motion detector).  
Adjustable continuously in the range 0.5 - 10 s.
- The multifunction red LED flashes or lights up depending on the operating status.

### Description

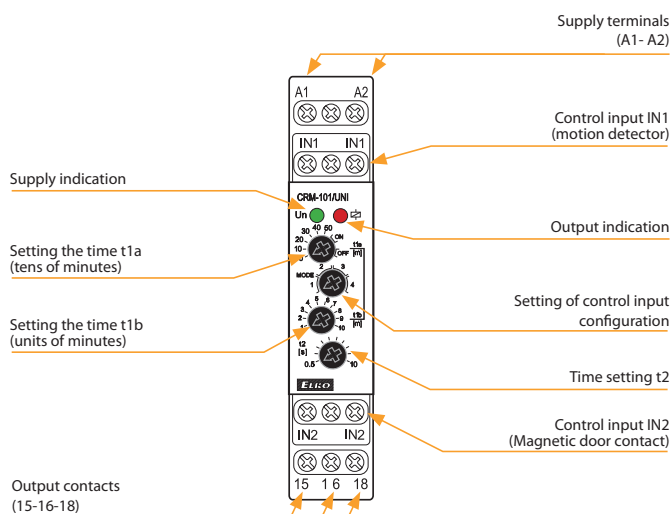

### Setting of control inputs configuration

MODE	IN1	IN2
1	NO	NO
2	NO	NC
3	NC	NO
4	NC	NC

### Example settings:

- door contact is NC (closed when the door is closed)
- motion detector has NC contact (closed at rest, opens when motion is detected)
- MODE must be set to position 4

### Connection

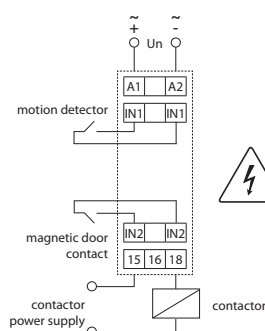

**Do not apply voltage to terminals IN1 and IN2 - the control contacts must be potential-free!**



## Function

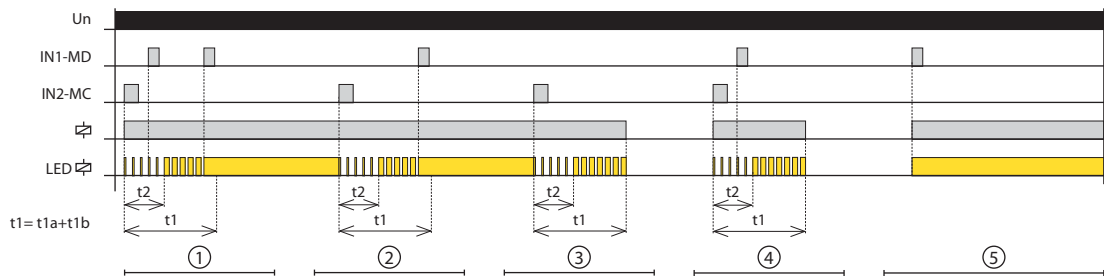

## ① Arrival of persons in the room

- When people enter the room, IN2 is activated (MC - magnetic door contact)
- closes the relay (turns on the electricity) and at the same time the delay  $t_1$  and  $t_2$  starts
  - The red LED flashes depending on the delay in progress.
- Contact IN1 (MD - motion detector), responds to the movement of people in the room
- during the delay  $t_2$ , the MD operation is blocked
  - if IN1 is activated after the delay  $t_2$  has elapsed or if the contact IN1 is already closed, the delay  $t_1$  ends and the red LED lights up permanently.
- The relay remains permanently closed.

## ② Person leaving the room

- When the person leaves the room, contact IN2 is activated
- delays  $t_1$  and  $t_2$  start at the same time
  - if there is a movement in the room after the delay  $t_2$  has elapsed, IN1 is activated, the delay  $t_1$  is terminated and the relay remains closed

## ③ Last person leaving the room

- When the person leaves the room, contact IN2 is activated
- Delays  $t_1$  and  $t_2$  start at the same time
  - if IN1 is not activated after the delay  $t_2$  has elapsed (there is no movement in the room), then after the delay  $t_1$  the red LED goes out and the relay opens (switches off the electricity).

④ No movement after delay  $t_2$ 

- When people enter the room, IN2 is activated (MC - magnetic door contact)
- closes the relay (turns on the electricity) and at the same time the delay  $t_1$  and  $t_2$  starts
  - if IN1 is not activated after the delay  $t_2$  has elapsed (e.g. a brief insight into the room), then after the delay  $t_1$  the red LED goes out and the relay opens (switches off the electricity).

## ⑤ Movement at rest

- Idle state - in case the IN1 does not activate the relay (switches off the electricity) after the person leaves the room after the delay  $t_2$  has elapsed. However, another person remains in the room motionless (e.g. sleeping)
- if IN1 is activated (e.g. by waking up a sleeping person), the relay closes without delay (turns on the electricity).

NEW



EAN code  
CRM-111H/UNI: 8595188175548  
CRM-113H/UNI: 8595188176880

Technical parameters	CRM-111H	CRM-113H
<b>Power supply</b>		
Supply terminals:	A1 - A2	
Voltage range:	AC/DC 12 - 240 V (AC 50/60 Hz)	
Power input (max.):	2 VA/1.5 W	2.5 VA/1.5 W
Supply voltage tolerance:	-15 %; +10 %	
Supply indication:	green LED	
<b>Time circuit</b>		
Number of functions:	11	10
Time ranges:	50 ms - 30 days	
Time setting:	rotary switches and potentiometers	
Time deviation*:	5 % - mechanical setting	
Repeat accuracy:	0.2 % - set value stability	
Temperature coefficient:	0.01 %/°C, at = 20 °C (0.01 %/°F, at = 68 °F)	
<b>Output</b>		
Number of contacts 1:	1x changeover/SPDT (AgNi)	
Current rating:	16 A/AC1	
Breaking capacity:	4000 VA/AC1, 384 W/DC	
Electrical life (AC1):	50.000 operations	
Number of contacts 2 (3):	x	2x chang./DPDT (AgNi)
Current rating:	x	8 A/AC1
Breaking capacity:	x	2000 VA/AC1, 192 W/DC
Electrical life (AC1):	x	10.000 operations
Switching voltage:	250V AC/24V DC	
Max. power dissipation:	1.2 W	2.4 W
Output indication:	multifunction red LED	
Mechanical life:	10.000.000 operations	
<b>Control</b>		
Control. terminals:	A1-S	
Load between S-A2:	Yes	
Impulse length:	min. 25 ms/max. unlimited	
Reset time:	max. 150 ms	
<b>Other information</b>		
Operating temperature:	-20 °C to +55 °C (-4 °F to 131 °F)	
Storage temperature:	-30 °C to +70 °C (-22 °F to 158 °F)	
Dielectrical strength:		
supply - output 1	4kV AC	
supply - output 2 (3)	x	1kV AC
output 1 - output 2	x	1kV AC
output 2 - output 3	x	1kV AC
Operating position:	any	
Mounting:	DIN rail EN 60715	
Protection degree:	IP40 from front panel/IP20 terminals	
Overvoltage category:	III.	
Pollution degree:	2	
Max. cable size (mm <sup>2</sup> ):	solid wire max. 1x 2.5 or 2x 1.5/ with sleeve max. 1x 2.5 (AWG 12)	
Dimensions:	90 x 17.6 x 64 mm (3.5" x 0.7" x 2.5")	
Weight:	62 g (2.2 oz.)	85 g (3 oz.)
Standards:	EN 61812-1	

- Multifunction time relay for universal use in automation, control and regulation or in house installations.
- All functions initiated by the supply voltage, except for the flasher function, can use the control input to inhibit the delay (pause).
- Mode selection - according to the set function, permanently closed, permanently open, function of MEMORY LATCH with delay (CRM-111H) or switching of the second output contact according to supply voltage (CRM-113H).
- Multifunction red LED flashes or shines depending on the operating status.

## Description

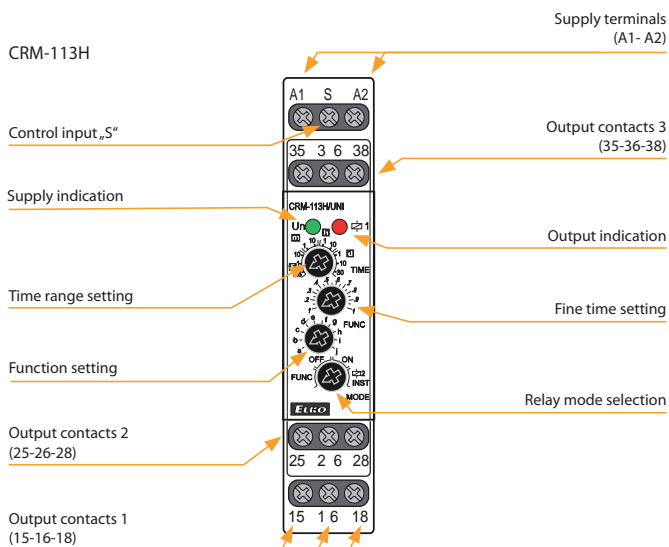

## Connection

CRM-111H

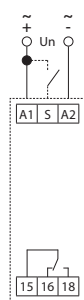

CRM-113H

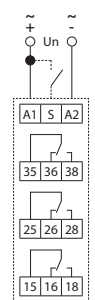

**CRM-113H:**  
The potential difference between the supply terminals (A1-A2), output contact 2 (25-26-28) and output contact 3 (35-36-38) must be a maximum of 250V AC rms/DC.

## Possibility to connect load onto controlling input

It is possible to connect the load (e.g.: contactor) between terminals S-A2, without any interruption of correct relay function.

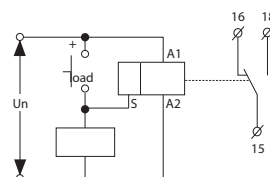

\* for adjustable delay <100 ms, a time deviation of ± 10 ms applies

Indication of operating states



Mode selection

FUNC. SETTINGS FUNCTION MODE

The desired function a-j is set with the FUNC rotary switch.

OFF. OUTPUT CONTACT OPEN MODE



ON. OUTPUT CONTACT CLOSED MODE



k. Function: MEMORY LATCH with delay (Only for CRM-111H)



When the supply voltage is applied, the relay is open. If the control contact is closed, the relay closes and the time delay T starts. It does not matter the length of the control pulse. When the timing is complete, the relay opens. If the control contact is closed during timing, the relay opens immediately. Each time the control contact closes during relay timing, it changes status.

2 INST. SECOND AND THIRD OUTPUT CONTACT INSTANTANEOUS (Only for CRM-113H)



The second output contact switches according to the supply voltage. The first output contact switches according to the function (a-j) set by the trimmer FUNC.

Function

For a description of the functions on page 21.



EAN code  
CRM-121H/UNI: 8595188175555

Technical parameters		CRM-121H
<b>Power supply</b>		
Supply terminals:	A1 - A2	
Voltage range:	AC/DC 12 - 240 V (AC 50/60 Hz)	
Power input (max.):	2 VA/1.5W	
Supply voltage tolerance:	-15 %; +10 %	
Supply indication:	green LED	
<b>Time circuit</b>		
Number of functions:	11	
Time ranges:	50 ms - 30 days	
Time setting:	rotary switch and potentiometer	
Time deviation*:	5 % - mechanical setting	
Repeat accuracy:	0.2 % - set value stability	
Temperature coefficient:	0.01 %/°C, at = 20 °C (0.01 %/°F, at = 68 °F)	
<b>Output</b>		
Number of contacts	1x changeover/SPDT (AgNi)	
Current rating:	16 A/AC1	
Breaking capacity:	4000 VA/AC1, 384 W/DC	
Switching voltage:	250V AC/24V DC	
Max. power dissipation:	1.2 W	
Output indication:	multifunction red LED	
Mechanical life:	10.000.000 operations	
Electrical life (AC1):	50.000 operations	
<b>Control</b>		
Control terminals:	S1-S2	
Impulse length:	min. 25 ms/max. unlimited	
Reset time:	max. 150 ms	
<b>Other information</b>		
Operating temperature:	-20 °C to +55 °C (-4 °F to 131 °F)	
Storage temperature:	-30 °C to +70 °C (-22 °F to 158 °F)	
Dielectrical strength:	4 kV AC (supply - output)	
	4 kV AC (supply - control input)	
Operating position:	any	
Mounting:	DIN rail EN 60715	
Protection degree:	IP40 from front panel/IP10 terminals	
Overvoltage category:	III.	
Pollution degree:	2	
Max. cable size (mm <sup>2</sup> ):	solid wire max. 2x 2.5 or 1x 4/	
	with sleeve max. 1x 2.5 or 2x 1.5 (AWG 12)	
Dimensions:	90 x 17.6 x 64 mm (3.5" x 0.7" x 2.5")	
Weight:	72 g (2.5 oz.)	
Standards:	EN 61812-1	

\* for adjustable delay <100 ms, a time deviation of ± 10 ms applies

**Function**

For a description of the functions on page 21.

- Multifunction time relay for universal use in automation, control and regulation or in house installations.
- Galvanically separated control input (Power Trigger)
- All functions initiated by the supply voltage, except for the flasher function, can use the control input to inhibit the delay (pause).
- Mode selection - according to the set function, permanently closed, permanently open, function of MEMORY LATCH with delay.
- Time scale 50 ms - 30 days divided into 10 ranges.
- Multifunction red LED flashes or shines depending on the operating status.

**Description**

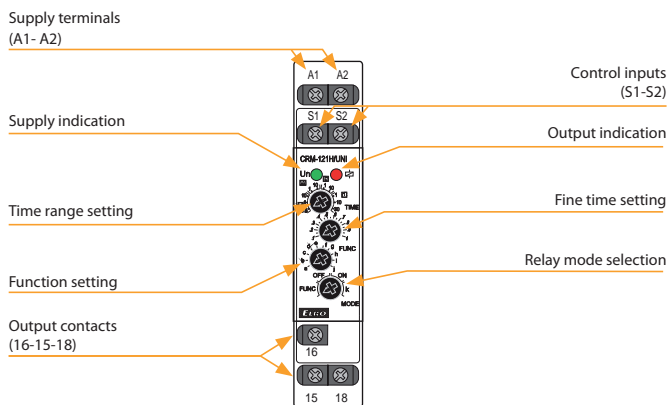

**Connection**      **Indication of operating states**

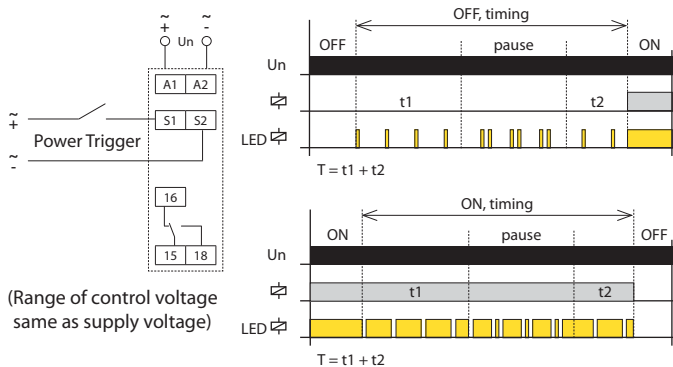

**Mode selection**

**FUNC. Settings function mode**  
The desired function a-j is set with the FUNC rotary switch.

**OFF. Output contact open mode**



**ON. Output contact closed mode**



**k. Function: MEMORY LATCH with delay**



When the supply voltage is applied, the relay is open. If the control contact is closed, the relay closes and the time delay T starts. It does not matter the length of the control pulse. When the timing is complete, the relay opens. If the control contact is closed during timing, the relay opens immediately. Each time the control contact closes during relay timing, it changes status.

Function

a. ON DELAY



When the supply voltage is applied, the time delay T begins. When the timing is complete, the relay closes and this condition continues until the supply voltage is disconnected.

ON DELAY with Inhibit

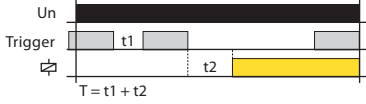

If the control contact is closed and the supply voltage is connected, the relay is opened and timing does not start until the control contact opens. When the timing is complete, the relay closes. If the control contact is closed during timing, the timing is interrupted and continues only after the control contact opens.

b. INTERVAL ON



After supply voltage relay closes and starts the delay time T. After the end of the timing relay opens and this state lasts until the supply voltage is disconnected.

INTERVAL ON with Inhibit

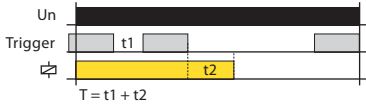

If the control contact is closed and the supply voltage is connected, the relay will close and the timing will start only after the control contact has been opened. When the timing is complete, the relay opens. If the control contact is closed during timing, the timing is interrupted and continues only after the control contact opens.

c. FLASHER - ON first



After supply voltage relay closes and starts the delay time T. After the end of the timing relay opens and again runs delay time T. When the timing is complete, the relay closes again and the sequence is repeated until the supply voltage is disconnected. If the control contact is closed during timing, this does not affect the operation of the cycler.

FLASHER - OFF first



If the control contact is closed during timing; this does not affect the operation of the cycler. If the control contact is closed and the supply voltage is connected, the cycler starts with a pause (relay open).

d. MEMORY LATCH



When the supply voltage is applied, the relay is open. When the control contact is closed, the relay closes. When the control contact is opened, the status does not change until the control contact is opened. When the control contact is closed again, the relay opens. Each time the control contact is closed, the relay changes status.

e. OFF DELAY



When the supply voltage is applied, the relay is open. When the control contact is closed, the relay closes. When the control contact opens, the time delay T begins. If the control contact is closed during timing, the time is reset and the relay remains closed. When the control contact opens, the time delay T starts again and opens when the relay closes.

f. SINGLE SHOT



When the supply voltage is applied, the relay is open. When the control contact is closed, the relay closes and the time delay T begins. Closing the control contact during timing is ignored.

g. WATCHDOG



When the supply voltage is applied, the relay is open. When the control contact is closed, the relay closes and the time delay T begins. Closing the control contact during timing triggers a new time delay T - the relay closing time is thus increased.

h. PULSE GENERATOR 0.5 s

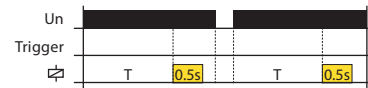

After the supply voltage has been applied, the time delay T begins. When the timing is complete, the relay closes for a fixed time (0.5 s).

PULSE GENERATOR 0.5 s with Inhibit

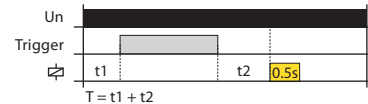

After supply voltage starts the time delay T. By closing timing of the control contact during timing is suspended. When the control contact opens, the time interval is completed and the relay closes for a fixed time (0.5 s).

i. INTERVAL ON/OFF

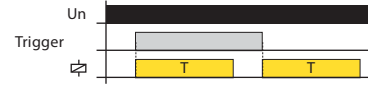

When the supply voltage is applied, the relay is open. When the control contact is closed, the relay closes and the time delay T begins. When the control contact is opened, the relay remains closed for 2T. When the timing is complete, the relay opens. Any other change of control contact status during timing is ignored.

j. ON/OFF DELAY

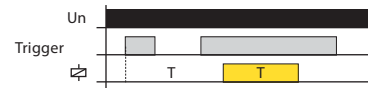

When the supply voltage is applied, the relay is open. If control contact is closed, time delay T starts. When the control contact is opened, a new time delay T begins. If the control contact is open during timing, the relay closes at the end of the timing and opens the relay after the new time delay. Any other change of control contact status during timing is ignored.

NEW



EAN code  
CRM-131H/UNI: 8595188175562

### Technical parameters

### CRM-131H

#### Power supply

Supply terminals:	A1 - A2
Voltage range:	AC/DC 12 - 240 V (AC 50/60 Hz)
Power input (max.):	2 VA/1.5W
Supply voltage tolerance:	-15 %; +10 %
Supply indication:	green LED

#### Time circuit

Number of functions:	11
Time ranges:	50 ms - 30 days
Time setting:	rotary switch and potentiometer
Time deviation*:	5 % - mechanical setting
Repeat accuracy:	0.2 % - set value stability
Temperature coefficient:	0.01 %/°C, at = 20 °C (0.01 %/°F, at = 68 °F)

#### Output

Number of contacts	1x changeover/SPDT (AgNi)
Current rating:	16 A/AC1
Breaking capacity:	4000 VA/AC1, 384 W/DC
Switching voltage:	250V AC/24V DC
Max. power dissipation:	1.2 W
Output indication:	multifunction red LED
Mechanical life:	10.000.000 operations
Electrical life (AC1):	50.000 operations

#### Control

Load between I, S, R - A2:	Yes
Control terminals:	I, S, R - A1
Impulse length:	min. 25 ms/max. unlimited
Reset time:	max. 150 ms

#### Other information

Operating temperature:	-20 °C to +55 °C (-4 °F to 131 °F)
Storage temperature:	-30 °C to +70 °C (-22 °F to 158 °F)
Dielectrical strength:	4 kV AC (supply - output)
Operating position:	any
Mounting:	DIN rail EN 60715
Protection degree:	IP40 from front panel/IP20 terminals
Overvoltage category:	III.
Pollution degree:	2
Max. cable size (mm <sup>2</sup> ):	solid wire max. 1x 2.5 or 2x 1.5/ with sleeve max. 1x 2.5 (AWG 12)
Dimensions:	90 x 17.6 x 64 mm (3.5" x 0.7" x 2.5")
Weight:	61 g (2.2 oz.)
Standards:	EN 61812-1

\* for adjustable delay <100 ms, a time deviation of ± 10 ms applies

### Function

For a description of the functions on page 23

- Multifunction time relay for universal use in automation, control and regulation or in house installations.
- Three control inputs - START, INHIBIT, RESET.
- Mode selection - according to the set function, permanently closed, permanently open, function of MEMORY LATCH with delay.
- Multifunction red LED flashes or shines depending on the operating status.

### Description

Supply terminals  
(A1 - A2)

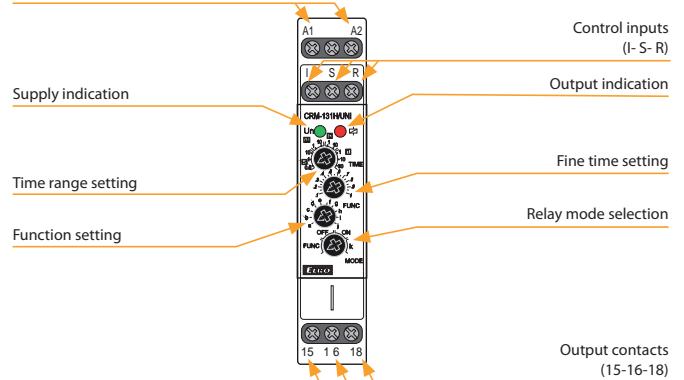

### Connection

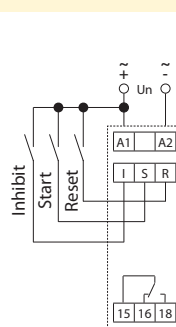

### Indication of operating states

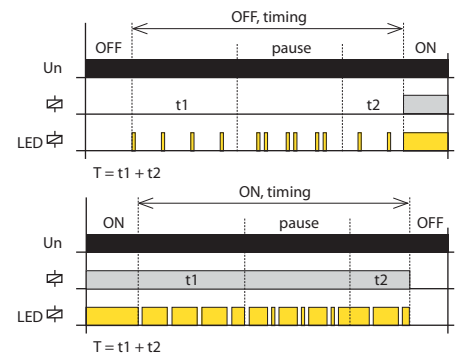

### Mode selection

#### FUNC. Settings function mode

The desired function a-j is set with the FUNC rotary switch.

#### OFF. Output contact open mode



#### ON. Output contact closed mode



#### k. MEMORY LATCH with delay

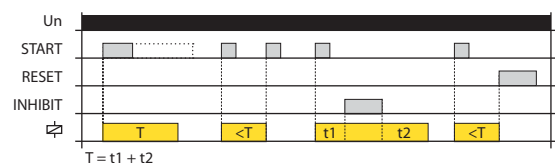

When the supply voltage is applied, the relay is open. If the START control contact is closed, the relay closes and the time delay T starts. It does not matter the length of the control pulse. When the timing is complete, the relay opens. If the START control contact is closed during timing, the relay opens immediately. Each time the control contact closes during relay timing, it changes status. Closing the INHIBIT control contact pauses the timing, after opening the INHIBIT control contact the timing continues from the moment of interruption. Closing the RESET control contact immediately ends the timing and the relay opens, just like as when the supply voltage is disconnected.

Function

Control input function description:

- Contact START starts the time function
- INHIBIT contact pauses timing (pause)
- The RESET contact simulates switching the supply voltage on and off

Same for all features:

- If the control contact START is closed and the supply voltage is connected, the time function is activated when the supply voltage is connected.
- Closing the control contact INHIBIT pauses the timing, after opening the control contact INHIBIT timing continues from the moment of interruption.
- If the INHIBIT control contact is closed, the START control contact is activated and the timing is paused.
- Closing the control contact RESET immediately terminates the timing and the relay opens, just as when the supply voltage is disconnected.
- If the control contact RESET is closed and then the control contact START is closed, the time function is activated when the control contact RESET is opened as well as when the supply voltage is connected.

a. ON DELAY with Control Signal

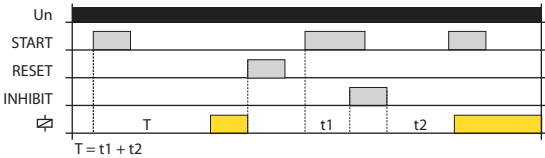

When the supply voltage is applied, the relay is open. If the control contact START is closed, the time delay T starts. The closing of the START control contact during timing is ignored.

b. INTERVAL ON with Control Signal

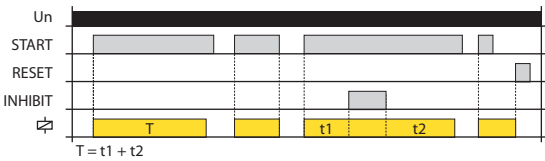

When the supply voltage is applied, the relay is open. When the control contact START is closed, the relay closes and the time delay T begins. If the START control contact is open during timing, the time interval is immediately terminated and the relay opens.

c. FLASHER - ON first with Control Signal

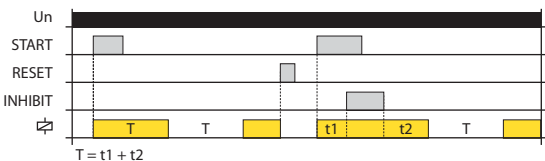

When the supply voltage is applied, the relay is open. When the START control contact is closed, the relay energizes and starts the delay time T. After the end of the timing relay opens and again runs delay time T. Upon completion timing again switches, and the sequence is repeated until the supply voltage is disconnected.

d. FLASHER - OFF first with Control Signal

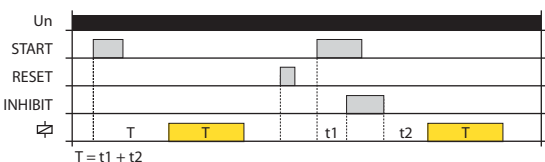

When the supply voltage is applied, the relay is open. When the START control contact is closed, starts the time delay T. After the end of the timing relay closes and again runs delay time T. After the end of the timing relay opens and the sequence is repeated until the supply voltage is disconnected.

e. OFF DELAY

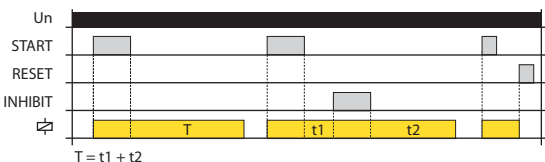

When the supply voltage is applied, the relay is open. If the control contact START is closed, the relay closes. After tripping Contact Start starts the delay time T. After the end of the timing relay is switched off.

f. SINGLE SHOT

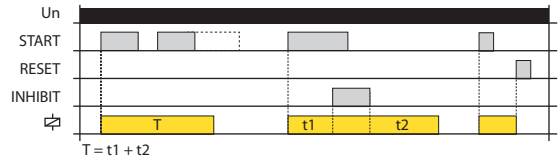

When the supply voltage is applied, the relay is open. When the START control contact is closed, the relay energizes and starts the delay time T. After the end of the timing relay is switched off. The closing of the START control contact during timing is ignored.

g. WATCHDOG

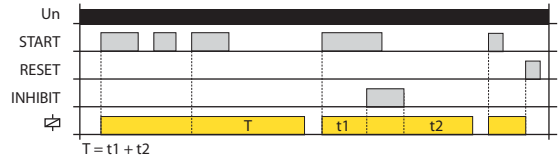

When the supply voltage is applied, the relay is open. When the START control contact is closed, the relay energizes and starts the delay time T. After the end of the timing relay is switched off. Closing control contact START during timing triggers a new time delay T - the relay closing time is thus increased.

h. PULSE GENERATOR 0.5 s with Control Signal

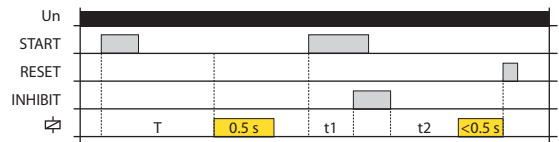

When the supply voltage is applied, the relay is open. When the START control contact is closed, starts the time delay T. After the end of the timing relay switches for the fixed time (0.5 sec).

i. INTERVAL ON/OFF

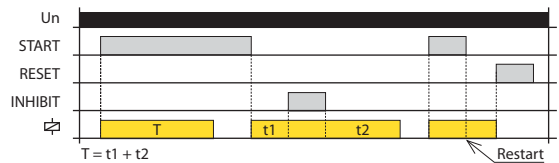

When the supply voltage is applied, the relay is open. When the START control contact is closed, the relay energizes and starts the delay time T. After the end of the timing relay is switched off. By opening the control contact start relay again closes and starts the delay time T. After the end of the timing relay is switched off.

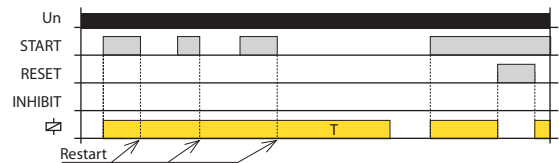

If the START control contact is open during timing, a restart occurs - the relay remains closed and a new time delay T begins. When the timing is complete, the relay opens.

j. ON/OFF DELAY

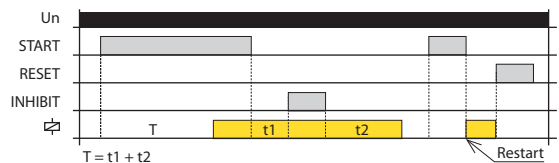

When the supply voltage is applied, the relay is open. When the START control contact is closed, starts the time delay T. After the end of the timing relay switches. Opening the control contact START starts a new time delay T. When the timing is complete, the relay opens.

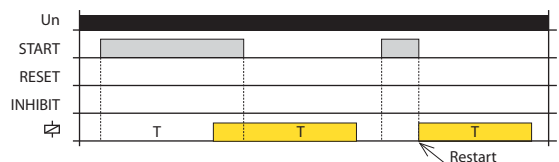

If the START control contact is open during timing, a restart occurs - the relay closes and a new time delay T begins. When the timing is complete, the relay opens.



EAN code  
CRM-82TO/UNI: 8595188137614

**Technical parameters CRM-82TO**

Number of functions:	a - On Delay (Power On)/ e - Off Delay (S Break)
Supply terminals:	A1 - A2
Voltage range:	AC/DC 12 - 240 V (AC 50/60 Hz)
Burden (max.):	AC 0.7 - 3 VA/DC 0.5 - 1.7 W
Max. dissipated power (Un + terminals):	2.5 W
Supply voltage tolerance:	-15 %; +10 %
Supply indication:	green LED
Time ranges:	0.1 s - 10 min
Time setting:	potentiometer
Time deviation:	5 % - mechanical setting
Repeat accuracy:	0.2 % - set value stability
Temperature coefficient:	0.1 %/°C, at = 20 °C (0.1 %/°F, at = 68 °F)

<b>Output</b>	
Number of contacts:	2x changeover/DPDT (AgNi/Silver Alloy)
Current rating:	8 A/AC1
Breaking capacity:	2000 VA/AC1, 192 W/DC
Inrush current:	10 A/<3 s
Switching voltage:	250V AC/24V DC
Output indication:	red LED
Mechanical life:	30.000.000 operations
Electrical life (AC1):	70.000 operations

<b>Other information</b>	
Operating temperature:	-20 °C to 55 °C (-4 °F to 131 °F)
Storage temperature:	-30 °C to 70 °C (-22 °F to 158 °F)
Electrical strength:	4 kV (supply-output)
Operating position:	any
Mounting:	DIN rail EN 60715
Protection degree:	IP40 from front panel/IP10 terminals
Overvoltage category:	III.
Pollution degree:	2
Max. cable size (mm <sup>2</sup> ):	solid wire max. 2x 2.5 or 1x 4, with sleeve max. 2x 1.5 or 1x 2.5 (AWG 12)
Dimensions:	90 x 17.6 x 64 mm (3.5" x 0.7" x 2.5")
Weight:	73 g (2.6 oz.)
Standards:	EN 61812-1

- „True OFF“ relay - relay timing without supply voltage.
- Example of use: back-up source for Delay OFF in case of voltage failure (e.g. emergency lighting, emergency respirator, or protection of el. controlled doors - in case of fire).
- 2 time functions adjustable by rotary switch:  
a - Delayed return after disconnecting of supply  
e - Delayed start.
- Time range (adjustable by rotary switch and fine setting by potentiometer): 0.1 s - 10 min.
- Interruptions in the power supply must take time steps (tens to hundreds of milliseconds).
- Output status indicated by red LED (only in case of supply voltage connection).

**Description**

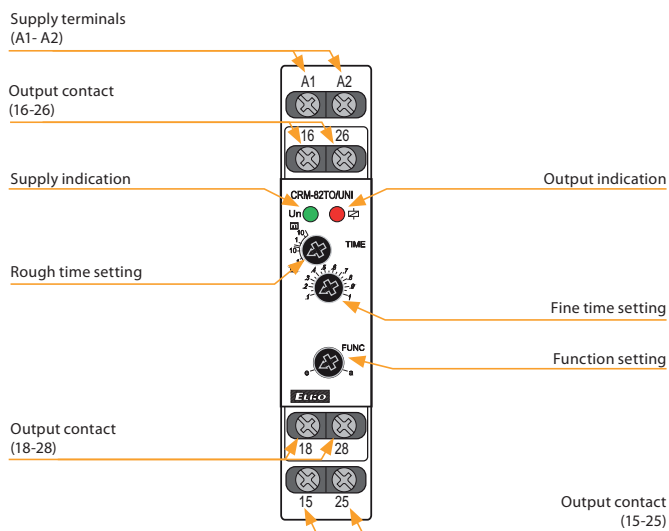

**Function**

a - Delay OFF (S break) the power supply is switched off (min. time is 0.5 s)  
 e - On Delay (S break)



**Connection**

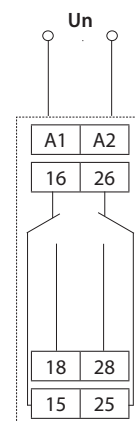

**Symbol**

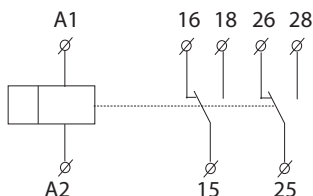





EAN code  
CRM-2T/230 V: 8595188112291  
CRM-2T/UNI: 8595188112437

**Technical parameters CRM-2T**

**Power supply**

Supply terminals:	A1 - A2
Voltage range:	AC/DC 12 - 240 V (AC 50/60 Hz)
Power input (max.):	2 VA/1.5 W
Voltage range:	AC 230 V (50/60 Hz)
Power input (max.):	AC 3VA/1.4W
Supply voltage tolerance:	-15 %; +10 %
Supply indication:	green LED

**Function**

Time scale:	t1: 0.1 s - 100 days, t2: 0.1 s - 1 s
Time setting:	rotary switch and potentiometer
Time deviation:	5% - mechanical setting
Repeat accuracy:	0.2 % - set value stability
Temperature coefficient:	0.01 %/°C, at = 20 °C (0.01 %/°F, at = 68 °F)

**Output**

Number of contacts:	2x changeover/SPDT (AgNi)
Current rating:	16 A/AC1
Breaking capacity:	4000 VA/AC1, 384 W/DC
Inrush current:	30 A/< 3 s
Switching voltage:	250V AC/24V DC
Max. power dissipation:	1.2 W
Output indication:	multifunction red LED
Mechanical life:	10.000.000 operations
Electrical life (AC1):	50.000 operations
Reset time:	max. 150 ms

**Other information**

Operating temperature:	-20 °C to 55 °C (-4 °F to 131 °F)
Storage temperature:	-30 °C to 70 °C (-22 °F to 158 °F)
Dielectrical strength:	
supply - output 1	4 kV AC
supply - output 2	4 kV AC
output 1 - output 2	4 kV AC
Operating position:	any
Mounting:	DIN rail EN 60715
Protection degree:	IP40 from front panel/IP20 terminals
Overvoltage category:	III.
Pollution degree:	2
Terminal wire capacity (mm²):	max.1x 2.5, 2x1.5, with sleeve max. 1x 2.5 (AWG 12)
Dimensions:	90 x 17.6 x 64 mm (3.5" x 0.7" x 2.5")
Weight:	UNI - 78 g (2.8 oz.), 230 - 73 g (2.6 oz.)
Standards:	EN 61812-1

**Symbol**

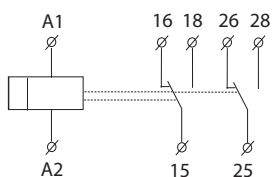

- It serves for delay ON of motors star/delta.
- Time t1 (star):
  - time range setting by rotary switch
  - fine time setting by potentiometer
- Time t2 (delay) between λ/Δ
  - fine time setting by potentiometer
- Multifunction red LED flashes or shines depending on the operating status.

**Description**

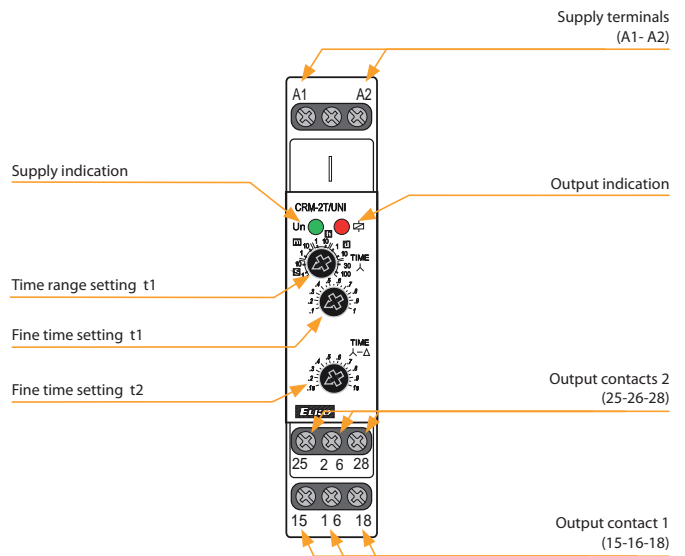

**Function**

STAR/DELTA timer

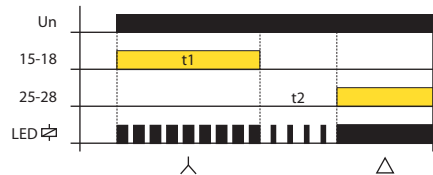

**Connection**

Start up of motor (λ - Δ)

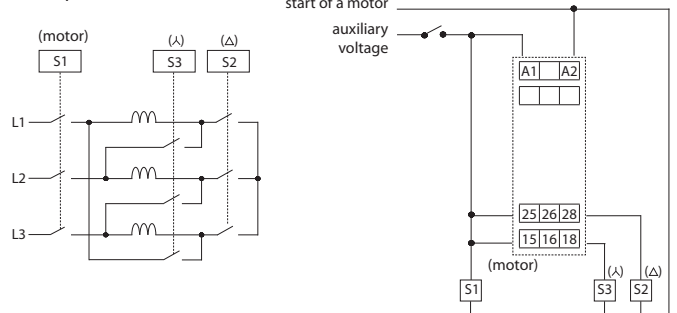



EAN code

CRM-181J/UNI ZR: 8595188176606  
 CRM-181J/UNI ZN: 8595188176613  
 CRM-181J/UNI BL: 8595188176620  
 CRM-181J/UNI OD: 8595188176637

CRM-183J/UNI ZR: 8595188176743  
 CRM-183J/UNI ZN: 8595188176750  
 CRM-183J/UNI BL: 8595188176767  
 CRM-183J/UNI OD: 8595188176774

Technical parameters	CRM-181J	CRM-183J
<b>Power supply</b>		
Supply terminals:	A1 - A2	
Voltage range:	AC/DC 12 - 240 V (AC 50/60 Hz)	
Power input (max.):	2 VA/1.5 W	2.5 VA/1.5 W
Supply voltage tolerance:	-15 %; +10 %	
Supply indication:	green LED	
<b>Time circuit</b>		
Time ranges:	0.1 s - 100 h	
Time setting:	rotary switch and potentiometer	
Time deviation:	5 % - mechanical setting	
Repeat accuracy:	0.2 % - set value stability	
Temperature coefficient:	0.01%/°C, at =20 °C (0.01 %/°F, at = 68°F)	
<b>Output</b>		
Output contact 1:	1x changeover/SPDT (AgNi)	
Current rating:	16 A/AC1	
Breaking capacity:	4000 VA/AC1, 384 W/DC	
Electrical life (AC1):	50.000 operations	
Output contact 2 (3):	x	2x chang./DPDT (AgNi)
Current rating:	x	8 A/AC1
Breaking capacity:	x	2000 VA/AC1, 192 W/DC
Electrical life (AC1):	x	10.000 operations
Switching voltage:	250V AC/24V DC	
Max. power dissipation:	1.2 W	2.4 W
Output indication:	multifunction red LED	
Mechanical life:	10.000.000 operations	
<b>Control</b>		
Control terminals:	A1-S	
Load between S-A2:	Yes	
Impulse length:	min. 25 ms/max. unlimited	
Reset time:	max. 150 ms	
<b>Other information</b>		
Operating temperature:	-20 °C to +55 °C (-4 °F to 131 °F)	
Storage temperature:	-30 °C to +70 °C (-22 °F to 158 °F)	
Dielectrical strength:		
supply - output 1	4kV AC	
supply - output 2 (3)	x	1kV AC
output 1 - output 2	x	1kV AC
output 2 - output 3	x	1kV AC
Operating position:	any	
Mounting:	DIN rail EN 60715	
Protection degree:	IP40 from front panel/IP20 terminals	
Overvoltage category:	III.	
Pollution degree:	2	
Max. cable size (mm <sup>2</sup> ):	solid wire max. 1x 2.5 or 2x 1.5/ with sleeve max. 1x 2.5 (AWG 12)	
Dimensions:	90 x 17.6 x 64 mm (3.5" x 0.7" x 2.5")	
Weight:	61 g (2.2 oz.)	84 g (3 oz.)
Standards:	EN 61812-1	

- Singlefunction time relays are suitable for applications where there is a clear function requirement in advance and are suitable for universal use in automation, control and regulation or in house installations.
- Choice of four types: ZR, ZN, BL, OD.
- All functions initiated by the supply voltage can use the control input to inhibit the ongoing delay (pause).
- Multifunction red LED flashes or shines depending on the operating status.

## Description

CRM-183J

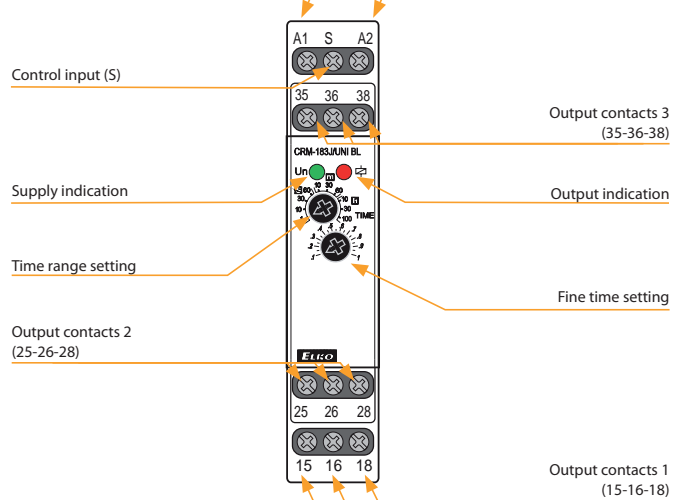
Supply terminals  
(A1 - A2)

## Connection

CRM-181J

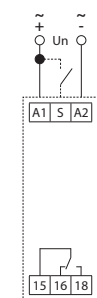

CRM-183J

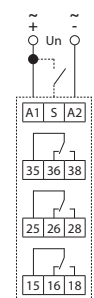

**CRM-183J:**  
 The potential difference between the supply terminals (A1-A2), output contact 2 (25-26-28) and output contact 3 (35-36-38) must be a maximum of 250V AC rms/DC.

## Possibility to connect load onto controlling input

It is possible to connect the load (e.g.: contactor) between terminals S-A2, without any interruption of correct relay function.

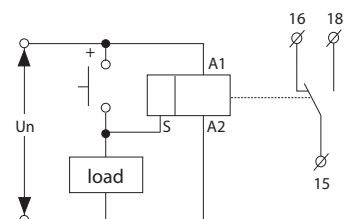

Indication of operating states

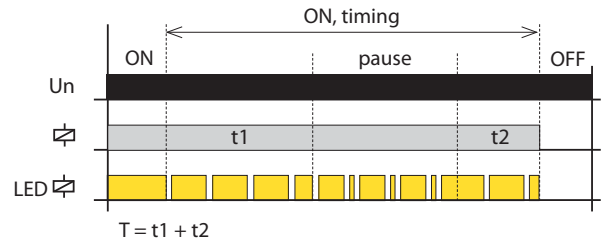
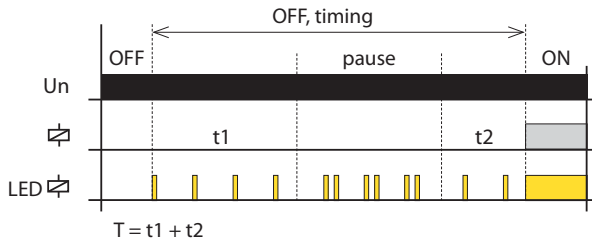

Function

ZR: ON DELAY



When the supply voltage is applied, the time delay T begins. When the timing is complete, the relay closes and this condition continues until the supply voltage is disconnected.

BL: FLASHER - ON first



If the control contact is closed and the supply voltage is connected, the relay will close and the timing will start only after the control contact has been opened. When the timing is complete, the relay opens.

ON DELAY with Inhibit

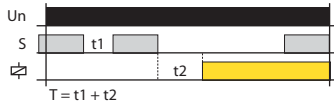

If the control contact is closed and the supply voltage is connected, the relay is opened and timing does not start until the control contact opens. When the timing is complete, the relay closes. If the control contact is closed during timing, the timing is interrupted and continues only after the control contact opens.

FLASHER - ON first with Inhibit

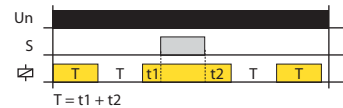

If the control contact is closed during an active timer setting, the timing is interrupted and continues only after the control contact opens again.

ZN: INTERVAL ON



After supply voltage relay closes and starts the delay time T. After the end of the timing relay opens and this state lasts until the supply voltage is disconnected.

OD: OFF DELAY



When the supply voltage is applied, the relay is open. When the control contact is closed, the relay closes. When the control contact opens, the time delay T begins. If the control contact is closed during timing, the time is reset and the relay remains closed. When the control contact opens, the time delay T starts again and opens when the relay closes.

INTERVAL ON with Inhibit

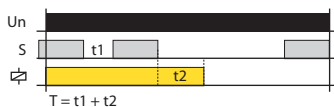

If the control contact is closed and the supply voltage is connected, the relay will close and the timing will start only after the control contact has been opened. When the timing is complete, the relay opens. If the control contact is closed during timing, the timing is interrupted and continues only after the control contact opens.

Note: ZR, ZN and BL functions are initiated by connecting the supply voltage to the product, i.e. In the event of a failure and recovery of the supply voltage, the relay automatically performs 1 cycle.



EAN code  
CRM-2H/230V: 8595188124201  
CRM-2H/UNI: 8595188113007

Technical parameters		CRM-2H
<b>Power supply</b>		
Supply terminals:		A1 - A2
Voltage range:	UNI	AC/DC 12 - 240 V (AC 50/60 Hz)
Power input (max.):		2 VA/1.5 W
Voltage range:	230	AC 230 V (50/60 Hz)
Power input (max.):		AC 3VA/1.4W
Supply voltage tolerance:		-15 %; +10 %
Supply indication:		green LED
<b>Function</b>		
Time scale:		0.1 s - 100 days
Time setting:		rotary switch and potentiometer
Time deviation:		5 % - mechanical setting
Repeat accuracy:		0.2 % - set value stability
Temperature coefficient:		0.01 %/°C, at = 20°C (0.01 %/°F, at = 68°F)
<b>Output</b>		
Number of contacts:		1x changeover/SPDT (AgNi)
Current rating:		16 A/AC1
Breaking capacity:		4000 VA/AC1, 384 W/DC
Inrush current:		30 A/< 3 s
Switching voltage:		250V AC/24V DC
Max. power dissipation:		1.2 W
Output indication:		multifunction red LED
Mechanical life:		10.000.000 operations
Electrical life (AC1):		50.000 operations
Reset time:		max. 150 ms
<b>Other information</b>		
Operating temperature:		-20 °C to 55 °C (-4 °F to 131 °F)
Storage temperature:		-30 °C to 70 °C (-22 °F to 158 °F)
Dielectrical strength:		4 kV AC (supply - output)
Operating position:		any
Mounting:		DIN rail EN 60715
Protection degree:		IP40 from front panel/IP20 terminals
Overvoltage category:		III.
Pollution degree:		2
Terminal wire capacity (mm²):		solid wire max. 1x 2.5 or 2x 1.5/ with sleeve max. 1x 2.5 (AWG 12)
Dimensions:		90 x 17.6 x 64 mm (3.5" x 0.7" x 2.5")
Weight		UNI - 61 g (2.2 oz.), 230 - 58 g (2 oz.)
Standards:		EN 61812-1

### Symbol

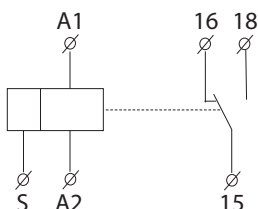

- Flasher with independent adjustable switch ON and switch OFF.
- Used for regular room ventilation, cyclic dehumidification, light control, circulating pumps, illuminated advertising, etc.
- 2 time functions:
  - 1) Asymmetric FLASHER - ON first
  - 2) Asymmetric FLASHER - OFF first
- Function choice is done by an external jumper of terminals S-A1.
- Time scale 0.1 s - 100 days divided into 10 time ranges.
- Time range setting via rotary switch.
- Fine time setting by potentiometer.
- Multifunction red LED flashes or shines depending on the operating status.

### Description

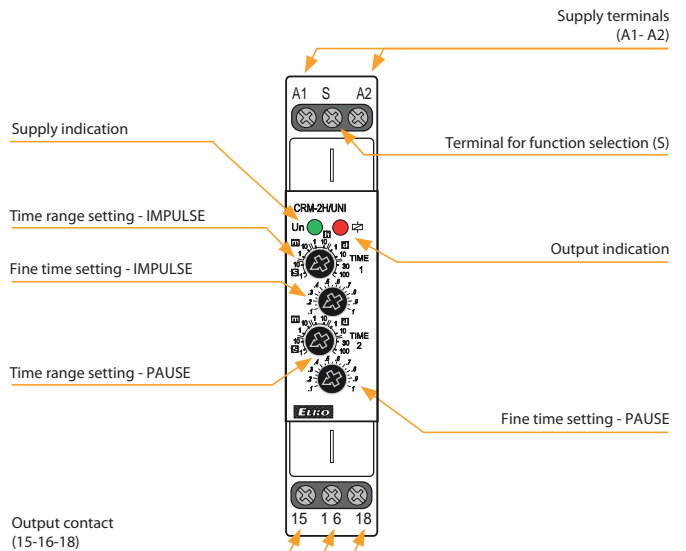

### Connection

#### Asymmetric FLASHER - ON first



#### Asymmetric FLASHER - OFF first (jumper S-A1)

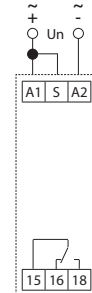

### Function

#### Asymmetric FLASHER - ON first

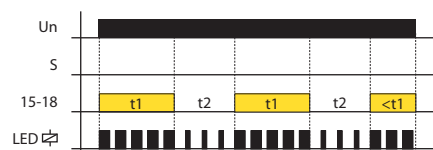

#### Asymmetric FLASHER - OFF first

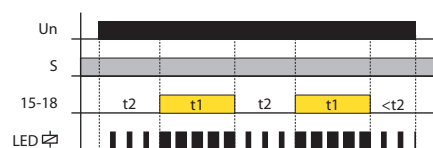



EAN code  
CRM-2HE /UNI + potentiometr: 8595188142069  
Potentiometr: 8595188125215

Technical parameters		CRM-2HE
Number of functions:	2	
Supply terminals:	A1 - A2	
Voltage range:	AC/DC 12 - 240 V (AC 50/60 Hz)	
Burden (max.):	AC 0.7 - 3 VA/DC 0.5 - 1.7 W	
Max. dissipated power:	4 W (Un + terminals)	
Supply voltage tolerance:	-15 %; +10 %	
Supply indication:	green LED	
Time ranges:	0.1 s - 100 days	
Time setting:	rotary switch, external potentiometer	
Time deviation:	5% - mechanical setting	
Repeat accuracy:	0.2 % - set value stability	
Temperature coefficient:	0.01 %/°C, at = 20°C (0.01%/°F, at = 68°F)	
Output		
Number of contacts:	1x changeover/SPDT (AgNi/Silver Alloy)	
Current rating:	16 A/AC1	
Breaking capacity:	4000 VA/AC1, 384 W/DC	
Inrush current:	30 A/<3 s	
Switching voltage:	250V AC/24V DC	
Output indication:	multifunction red LED	
Mechanical life:	30.000.000 operations	
Electrical life (AC1):	70.000 operations	
Controlling		
Control. voltage:	AC/DC 12 - 240 V (AC 50/60 Hz)	
Consumption of input:	AC 0.025-0.2 VA/DC 0.1-0.7 W	
Load between S-A2:	Yes	
Glow-tubes:	No	
Control. terminals:	A1-S	
Reset time:	max. 150 ms	
Other information		
Operating temperature:	-20 °C to +55 °C (-4 °F to 131 °F)	
Storage temperature:	-30 °C to +70 °C (-22 °F to 158 °F)	
Dielectrical strength:	4 kV (supply - output)	
Operating position:	any	
Mounting:	DIN rail EN 60715	
Protection degree:	IP40 from front panel/IP20 terminals	
Overvoltage category:	III.	
Pollution degree:	2	
Max. cable size (mm²):	solid wire max. 1x 2.5 or 2x 1.5/ with sleeve max. 1x 2.5 (AWG 12)	
Dimensions:	90 x 17.6 x 64 mm (3.5" x 0.7" x 2.5")	
Weight:	78 g (2.8 oz.)	
Standards:	EN 61812-1	
Potentiometer		
Potentiometer:	47 kΩ, linear	
Protection degree:	IP 65 from front side/IP20 from back side	
Max. cable size (mm²):	1.5 with sleeve/without sleeve max. 2.5 (AWG 12)	
Weight:	22 g (0.8 oz.)	
Dimensions:	see page Accessories	

- Control by external control unit - potentiometer (can be placed/ mounted for example on switch board doors or in panel).
- Asymmetric cyclers - 2 time functions:  
flasher beginning with pulse  
flasher beginning with gap.
- Function selected via external wired link on control input S-A1.
- Possible to connect external potentiometer - max. distance 10 m (32.8 ft.) from relay.

Description

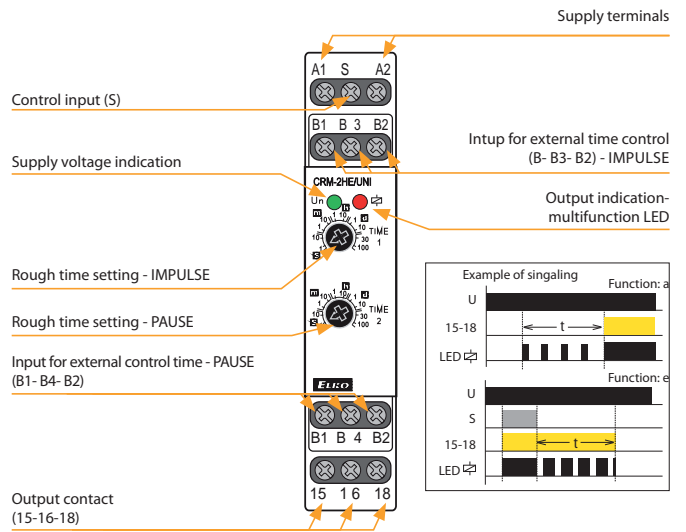

Connection

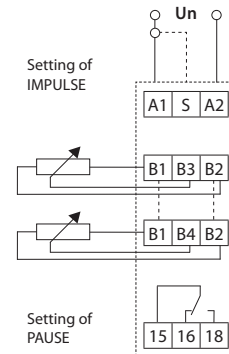

Symbol

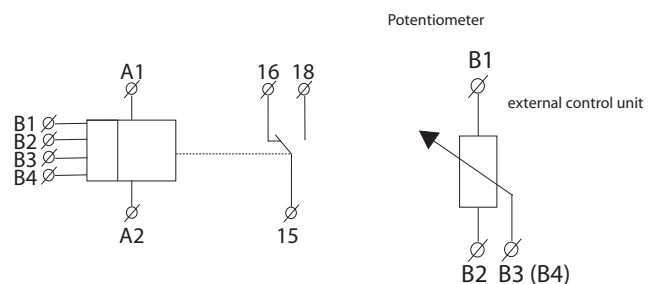

Function

Functions of CRM-2HE are identical with CRM-2H (page: 28).



EAN code

SJR-2/230V: 8595188116015

SJR-2/UNI: 8595188117401

### Technical parameters

### SJR-2

#### Power supply

Supply terminals:	A1 - A2
Voltage range:	AC/DC 12 - 240 V (AC 50/60 Hz)
Power input (max.):	2.5 VA/1.5 W
Voltage range:	AC 230 V (50/60 Hz)
Power input (max.):	AC 4VA/2W
Supply voltage tolerance:	-15 %; +10 %
Supply indication:	green LED

#### Function

Time ranges:	0.1 s - 10 days
Time setting:	rotary switch and potentiometer
Time deviation:	5 % - mechanical setting
Repeat accuracy:	0.2 % - set value stability
Temperature coefficient:	0.01 %/°C, at = 20 °C (0.01 %/°F, at = 68 °F)

#### Output

Number of contacts:	2x changeover/DPDT (AgNi)
Current rating:	16 A/AC1
Breaking capacity:	4000 VA/AC1, 384 W/DC
Inrush current:	30 A/< 3 s
Switching voltage:	250V AC/24V DC
Max. power dissipation:	2.4 W
Output indication:	multifunction red LED
Mechanical life:	10.000.000 operations
Electrical life (AC1):	50.000 operations
Reset time:	max. 150 ms

#### Other information

Operating temperature:	-20 °C to 55 °C (-4 °F to 131 °F)
Storage temperature:	-30 °C to 70 °C (-22 °F to 158 °F)
Dielectrical strength:	
supply - output 1	4 kV AC
supply - output 2	4 kV AC
output 1 - output 2	4 kV AC
Operating position:	any
Mounting:	DIN rail EN 60715
Protection degree:	IP40 from front panel/IP20 terminals
Overvoltage category:	III.
Pollution degree:	2
Max. cable size (mm <sup>2</sup> ):	solid wire max. 1x 2.5 or 2x1.5/ with sleeve max. 1x 2.5 (AWG 12)
Dimensions:	90 x 17.6 x 64 mm (3.5" x 0.7" x 2.5")
Weight:	UNI - 78 g (2.8 oz.), 230 - 75 g (2.6 oz.)
Standards:	EN 61812-1

#### Symbol

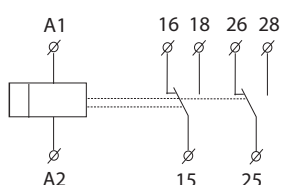

- For gradual switching of high power, prevents current strokes in the main.
- Double stage ON DELAY.
- Time scale 0.1 s - 10 days divided into 10 ranges:  
0.1 s - 1 s/1 s - 10 s/0.1 min - 1 min/1 min - 10 min/0.1 hrs - 1 h/1 h - 10 hrs/0.1 day - 1 day/1 day - 10 days/only ON/only OFF.
- Times t1 and t2 are independantly adjustable.
- Time range setting via rotary switch.
- Voltage range: AC 230 V or AC/DC 12 - 240 V.
- Output contact: 2 x changeover/DPDT 16 A.
- Multifunction red LED flashes or shines depending on the operating status.

### Description

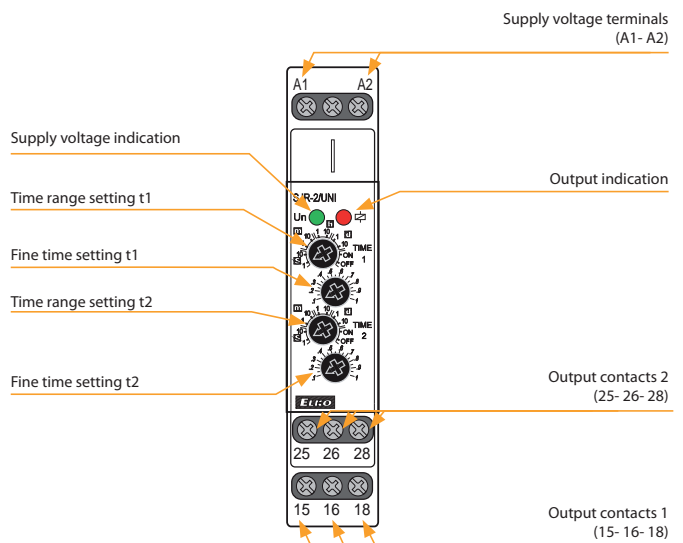

### Connection

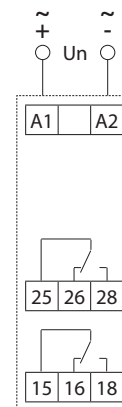

### Function

#### Double stage ON DELAY

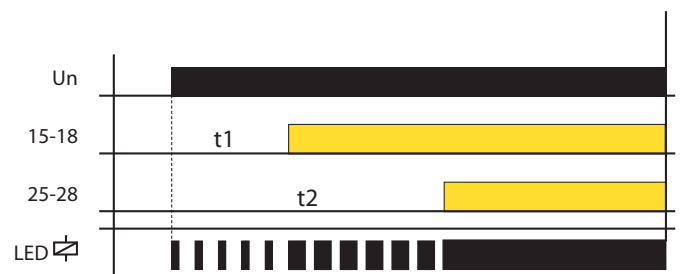



EAN code  
 PTRM-216TP/UNI: 8595188176033  
 PTRM-216KP/UNI: 8595188176026

Technical parameters	PTRM-216TP	PTRM-216KP
<b>Power supply</b>		
Power pins:	2, 10	
Voltage range:	AC/DC 12 – 240V (AC 50/60Hz)	
Power input (max.):	2.5 VA/1.5 W	
Supply voltage tolerance:	±10 %	
Supply indication:	green LED	
<b>Time circuit</b>		
Number of functions:	10	
Time ranges:	50 ms - 30 days	
Time setting:	rotary switch and potentiometer	
Time deviation:*	5 % - mechanical setting	
Repeat accuracy:	0.2 % - set value stability	
Temperature coefficient:	0.01 %/°C, at = 20 °C (0.01 %/°F, at = 68 °F)	
<b>Output</b>		
Number of contacts	2x changeover/SPDT (AgNi)	
Current rating:	16 A/AC1	
Breaking capacity:	4000 VA/AC1, 384 W/DC	
Switching voltage:	250V AC/24V DC	
Max. power dissipation:	2.4 W	
Output indication:	multifunction red LED	
Mechanical life:	10.000.000 operations	
Electrical life (AC1):	50.000 operations	
<b>Control</b>		
Control pins:	5 (2)-6	
Impulse length:	min. 25 ms/max. unlimited	
Reset time:	max. 150 ms	
<b>Other information</b>		
Operating temperature:	-20 °C to +55 °C (-4 °F to 131 °F)	
Storage temperature:	-30 °C to +70 °C (-22 °F to 158 °F)	
Dielectrical strength:	supply - output 1 (1, 3, 4)	2.5 kV AC
	supply - output 2 (8, 9, 11)	2.5 kV AC
	output 1 - output 2	2.5 kV AC
Operating position:	any	
Mounting:	11 pin octal socket	
Protection degree:	IP40 from front panel	
Overvoltage category:	for supply voltage 12-150V AC/DC	III.
	for supply voltage 150-240V AC/DC	II.
Pollution degree:	2	
Dimensions:	48x48x79mm (1.7" x1.7" x3.1")	48x48x89mm (1.7" x1.7" x3.5")
Weight:	111 g (3.9 oz.)	108 g (3.81 oz.)
Standards:	EN 61812-1	

\* for adjustable delay <100 ms, a time deviation of ± 10 ms applies

**Function**

For a description of the functions on page 21

- Multifunction time relay for universal use in automation, control and regulation or in house installations.
- Possibility to select the control element for fine time setting:  
**PTRM-216KP** - knob, for easy handling without the need for tools  
**PTRM-216TP** - rotary switch, for the possibility of using a sealable cover
- All functions initiated by the supply voltage, except for the flasher function, can use the control input to inhibit the delay (pause).
- Mode selection - according to the set function, permanently closed, permanently open, and switching of the second output contact according to the supply voltage.
- Multifunction red LED flashes or shines depending on the operating status.

**Description**

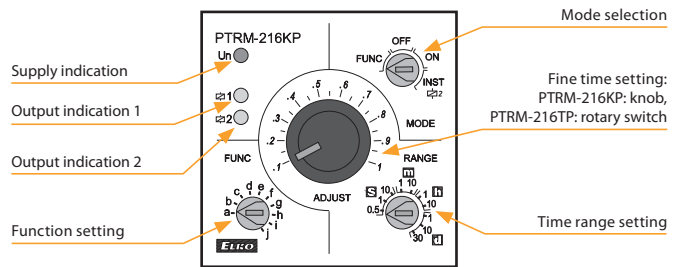

**Connection**      **Indication of operating states**

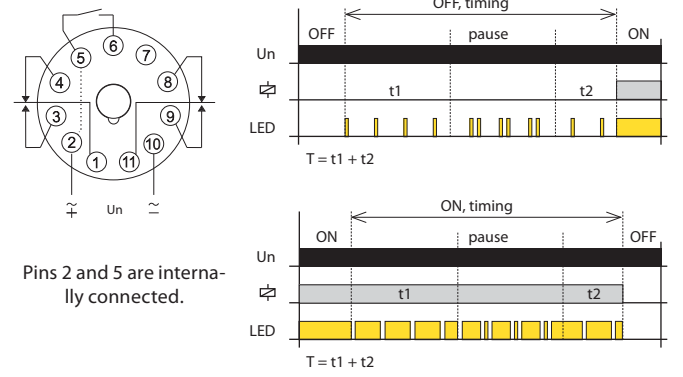

Pins 2 and 5 are internally connected.

**Mode selection**

**FUNC. Settings function mode**  
 The desired function a-j is set with the FUNC rotary switch.

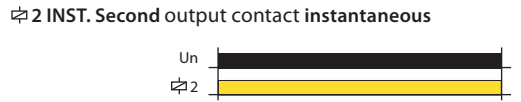
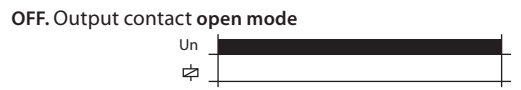

The second output contact switches according to the supply voltage. The first output contact switches according to the function (a-j) set by the trimmer FUNC.

NEW



EAN code  
PTRM-216T/UNI: 8595188175586  
PTRM-216K/UNI: 8595188175579

Technical parameters	PTRM-216T	PTRM-216K
<b>Power supply</b>		
Power pins:	2, 10	
Voltage range:	AC/DC 12 – 240V (AC 50/60Hz)	
Power input (max.):	2.5 VA/1.5 W	
Supply voltage tolerance:	±10 %	
Supply indication:	green LED	
<b>Time circuit</b>		
Number of functions:	10	
Time ranges:	50 ms - 30 days	
Time setting:	rotary switch and potentiometer	
Time deviation*:	5 % - mechanical setting	
Repeat accuracy:	0.2 % - set value stability	
Temperature coefficient:	0.01 %/°C, at = 20 °C (0.01 %/°F, at = 68 °F)	
<b>Output</b>		
Number of contacts:	2x changeover/SPDT (AgNi)	
Current rating:	16 A/AC1	
Breaking capacity:	4000 VA/AC1, 384 W/DC	
Switching voltage:	250V AC/24V DC	
Max. power dissipation:	2.4 W	
Output indication:	multifunction red LED	
Mechanical life:	10.000.000 operations	
Electrical life (AC1):	50.000 operations	
<b>Control</b>		
Control pins:	5 - 6	
Impulse length:	min. 25 ms/max. unlimited	
Reset time:	max. 150 ms	
<b>Other information</b>		
Operating temperature:	-20 °C to +55 °C (-4 °F to 131 °F)	
Storage temperature:	-30 °C to +70 °C (-22 °F to 158 °F)	
Dielectrical strength:		
supply - output 1 (1, 3, 4)	2.5 kV AC	
supply - output 2 (8, 9, 11)	2.5 kV AC	
output 1 - output 2	2.5 kV AC	
Operating position:	any	
Mounting:	11 pin octal socket	
Protection degree:	IP40 from front panel	
Overvoltage category:		
for supply voltage	12-150V AC/DC III.	
for supply voltage	150-240V AC/DC II.	
Pollution degree:	2	
Dimensions:	48x48x79mm (1.7"x1.7"x3.1")	48x48x89mm (1.7"x1.7"x3.5")
Weight:	111 g (3.9 oz.)	108 g (3.81 oz.)
Standards:	EN 61812-1	

\* for adjustable delay <100 ms, a time deviation of ± 10 ms applies

## Function

For a description of the functions on page 21.

- Multifunction time relay for universal use in automation, control and regulation or in house installations.
- Potential-free control input (Control Switch Trigger).
- Possibility to select the control element for fine time setting:  
PTRM-216K - knob, for easy handling without the need for tools  
PTRM-216T - rotary switch, for the possibility of using a sealable cover.
- All functions initiated by the supply voltage, except for the flasher function, can use the control input to inhibit the delay (pause).
- Mode selection - according to the set function, permanently closed, permanently open, and switching of the second output contact according to the supply voltage.
- Multifunction red LED flashes or shines depending on the operating status.

## Description

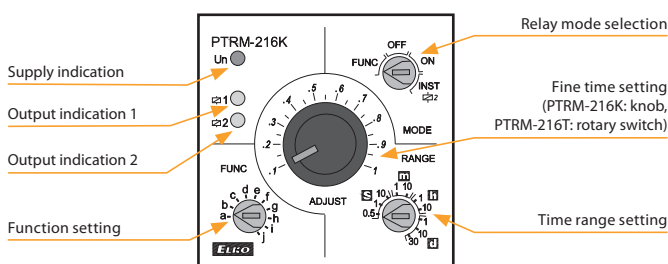

## Connection

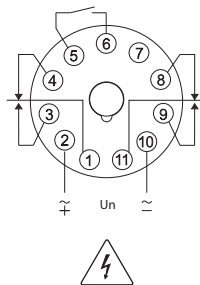

Do not apply voltage to terminals 5, 6, 7!

## Indication of operating states

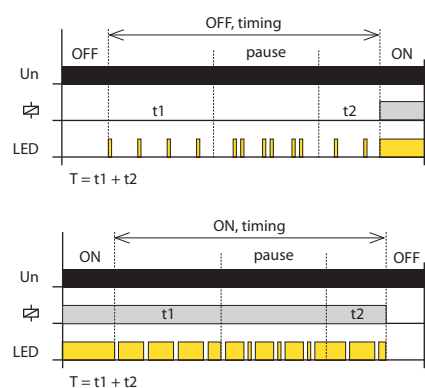

## Mode selection

### FUNC. Settings function mode

The desired function a-j is set with the FUNC rotary switch.

### OFF. output contact open mode



### ON. output contact closed mode



### 2 INST. Second output contact instantaneous



The second output contact switches according to the supply voltage. The first output contact switches according to the function (a-j) set by the trimmer FUNC.





EAN code  
PTRA-216T/UNI: 8595188175609  
PTRA-216K/UNI: 8595188175993

Technical parameters	PTRA-216T	PTRA-216K
<b>Power supply</b>		
Power pins:	2, 10	
Voltage range:	AC/DC 12 – 240V (AC 50/60Hz)	
Power input (max.):	2.5 VA/1.5 W	
Supply voltage tolerance:	±10 %	
Supply indication:	green LED	
<b>Time circuit</b>		
Number of functions:	10	
Time ranges:	50 ms - 30 days	
Time setting:	rotary switch and potentiometer	
Time deviation*:	5 % - mechanical setting	
Repeat accuracy:	0.2 % - set value stability	
Temperature coefficient:	0.01 %/°C, at = 20 °C (0.01 %/°F, at = 68 °F)	
<b>Output</b>		
Number of contacts	2x changeover/SPDT (AgNi)	
Current rating:	16 A/AC1	
Breaking capacity:	4000 VA/AC1, 384 W/DC	
Switching voltage:	250V AC/24V DC	
Max. power dissipation:	2.4 W	
Output indication:	multifunction red LED	
Mechanical life:	10.000.000 operations	
Electrical life (AC1):	50.000 operations	
<b>Control</b>		
Control pins:	5 - 2, 6 - 2, 7 - 2	
Impulse length:	min. 25 ms/max. unlimited	
Reset time:	max. 150 ms	
<b>Other information</b>		
Operating temperature:	-20 °C to +55 °C (-4 °F to 131 °F)	
Storage temperature:	-30 °C to +70 °C (-22 °F to 158 °F)	
Dielectrical strength:		
supply - output 1 (1, 3, 4)	2.5 kV AC	
supply - output 2 (8, 9, 11)	2.5 kV AC	
output 1 - output 2	2.5 kV AC	
Operating position:	any	
Mounting:	11 pin octal socket	
Protection degree:	IP40 from front panel	
Overvoltage category:		
for supply voltage 12-150V AC/DC	III.	
for supply voltage 150-240V AC/DC	II.	
Pollution degree:	2	
Dimensions:	48x48x79mm (1.7"x1.7"x3.1")	48x48x89mm (1.7"x1.7"x3.5")
Weight:	111 g (3.9 oz.)	108 g (3.81 oz.)
Standards:	EN 61812-1	

\* for adjustable delay <100 ms, a time deviation of ± 10 ms applies

- Multifunction time relay for universal use in automation, control and regulation or in house installations.
- Three control inputs - START, INHIBIT, RESET.
- Possibility to select the control element for fine time setting:  
PTRA-216K - knob, for easy handling without the need for tools  
PTRA-216T - rotary switch, for the possibility of using a sealable cover.
- Mode selection - according to the set function, permanently closed, permanently open, and switching of the second output contact according to the supply voltage.
- Universal supply voltage AC/DC 12 – 240 V.
- Multifunction red LED flashes or shines depending on the operating status.

**Description**

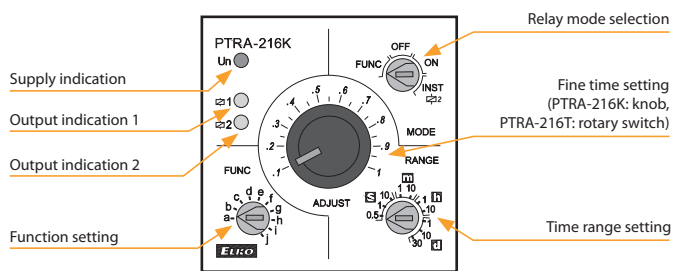

**Connection**

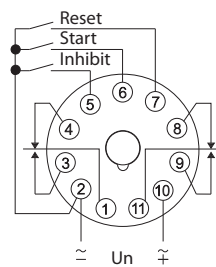

**Indication of operating states**

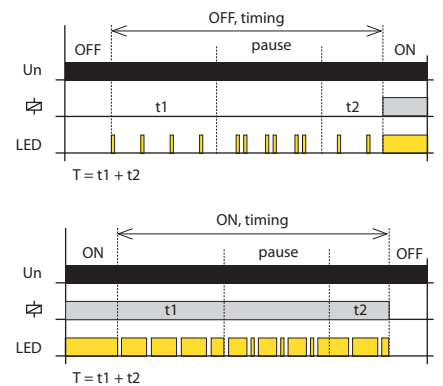

**Mode selection**

**FUNC. Settings function mode**

The desired function a-j is set with the FUNC rotary switch.

**OFF. Output contact open mode**



**ON. Output contact closed mode**



**o2 INST. Second output contact instantaneous**



The second output contact switches according to the supply voltage. The first output contact switches according to the function (a-j) set by the trimmer FUNC.

**Function**

For a description of the functions on page 23.



EAN code  
CRM-100: 8595188174534

Technical parameters	CRM-100
Number of functions:	17
Supply terminals:	A1 - A2
Voltage range:	AC/DC 24-240 V (50/60 Hz)
Consumption (apparent / loss):	AC max. 1-4 VA/DC max. 1-3 W
Max. dissipated power (Un + terminals):	4 W
Supply voltage tolerance:	-15 %; +10 %
Time ranges:	0.1 s - 999 hrs.
Time setting:	Buttons SET/ADJ
Repeat accuracy:	± 0.5 % - of selected range
Variation in timing due to voltage change:	± 2%
Variation in timing due to temperature change:	± 5%
<b>Output</b>	
Number of contacts:	1x C/O/SPDT (AgNi)
Current rating:	8 A/AC1
Breaking capacity:	2000 VA/AC1, 192 W/DC
Inrush current:	10 A/<3 s
Switching voltage:	250V AC/24V DC
Output indication:	multifunction red LED
Mechanical life:	20.000.000 operations
Electrical life (AC1):	100.000 operations
<b>Controlling</b>	
Control. terminals:	A1-B1
<b>Other information</b>	
Operating temperature:	-10 to +55 °C (14 to 131 °F)
Storage temperature:	-30 to +70 °C (-22 to 158 °F)
Isolation (Between Input and Output):	2.5 kV
Operating position:	any
Mounting:	DIN rail EN 60715
Protection degree:	IP30 from front panel/IP20 terminals
Overvoltage category:	III.
Pollution degree:	2
Max. cable size (mm <sup>2</sup> ):	solid wire max. 1x 2.5 or 2x 1.5/ with sleeve max. 1x 2.5 (AWG 12)
Dimensions:	85 x 18.2 x 76 mm (3.3" x 0.7" x 2.99")
Weight:	78 g (2.8 oz.)
Standards:	EN 61812-1

### Symbol

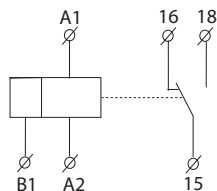

- Digital multifunction relay can be used for controlling lights, heating, motors, pumps, machines and appliances where you need set time functions.
- 17 most used functions.
- Thanks to digital display and settings you exact set required time (without any mechanical tolerance).
- Time range 0.1 s - 999 hours.
- Universal power supply 24-240 V AC/DC brings you variability of powering.
- Visible time function for non-authorized.

### Description

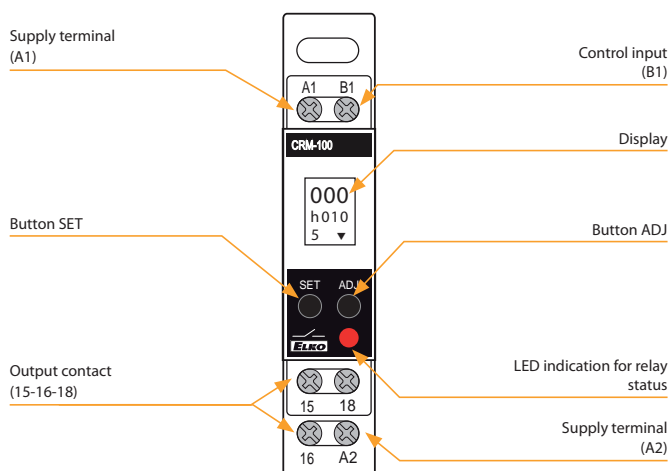

### Description of displayed elements on the screen

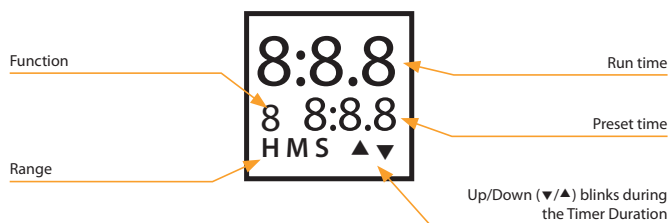

### Connection

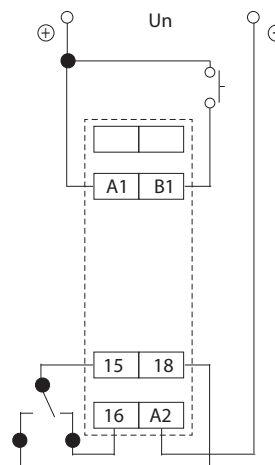

Function

- 0**



**ON delay [0]**  
Timing commences when supply is present. R energizes at the end of the timing period.

**A**



**Impulse ON/OFF [A]**  
Permanent supply is required. R energizes for the timing period when B1 is opened or closed. When timing commences, changing state of B1 does not affect R but resets timer.
- 1**

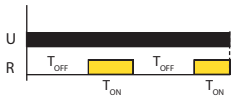

**Cyclic OFF/ON {OFF Start, (Sym, Asym)} [1]**  
T-ON and T-OFF can be same or different. The relay (R) keeps on changing its status till power is removed.

**B**



**Signal OFF/ON [b]**  
When switch B1 is closed or opened for preset time T, the relay changes its state after time duration T.
- 2**

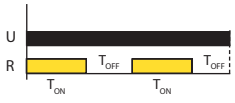

**Cyclic ON/OFF {On Start, (Sym, Asym)} [2]**  
This function is quite similar to the function '1' but initially the relay(R) is ON for period T-ON after the power is applied.

**C**

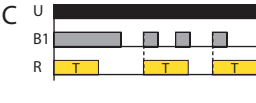

**Leading edge impulse1 [C]**  
A permanent supply is needed. When B1 is closed, output relay energizes until timing irrespective of any further action of B1.
- 3**



**Impulse ON energizing [3]**  
After power ON, R energizes and timing starts. R de-energizes after timing is over.

**D**

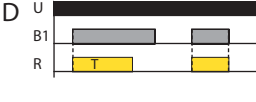

**Leading edge impulse2 [d]**  
Permanent supply is required. when switch B1 is closed, and remains closed output relay energizes until timing is over. If B1 is opened during timing, R resets.
- 4**

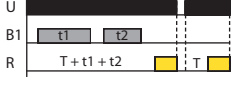

**Accumulative delay ON signal [4]**  
Time commences as supply is present and switch B1 is open. Closing switch B1 pauses timing. Timing resumes when switch B1 is opened again. R energizes at the end of timing.

**E**



**Trailing edge impulse1 [E]**  
Permanent supply is required. when B1 is opened, R energizes and de-energizes when timing is over. If B1 is closed during timing R resets.
- 5**

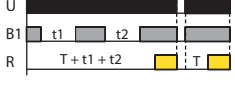

**Accumulative delay ON inverted signal [5]**  
Time commences as supply is present and switch B1 is closed. Opening switch B1 pauses timing. Timing resumes when switch B1 is closed again. R energizes at end of timing.

**F**



**Trailing edge impulse2 [F]**  
Permanent supply is required. When switch B1 is opened, R energizes and will de-energize when timing is over. If B1 is pulsed during timing period it will have no effect on R.
- 6**

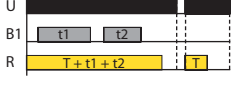

**Accumulative impulse ON signal [6]**  
When supply is ON, R energizes. When switch B1 is closed timing is suspended and remains suspended till switch B1 is opened again. Interrupting supply resets timer.

**G**

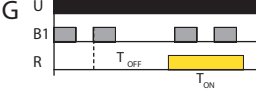

**Delayed impulse [G]**  
When switch B1 is closed, T<sub>OFF</sub> starts. Relay energizes at the end of T<sub>OFF</sub> period. Then, T<sub>ON</sub> starts irrespective of signal level and relay de-energizes at the end of T<sub>ON</sub> period.
- 7**



**Signal ON delay [7]**  
Permanent supply required. Timing starts when switch B1 is closed. R energizes at end of timing period and de-energizes when B1 is opened.

**8**

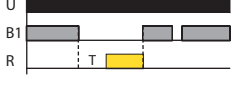

**Inverted signal ON delay [8]**  
Timing will commence when supply is present and switch B1 is open. R energizes after timing. If B1 is closed during timing period, timing resets to the beginning of cycle.
- 9**

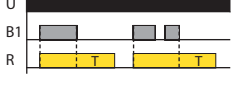

**Signal OFF delay [9]**  
Permanent supply is required. R energizes when switch B1 is closed. Timing commences after S is opened and then the relay de-energizes.



EAN code  
 PDR-2A/230V: 8594030333037  
 PDR-2A/UNI: 8594030333044  
 PDR-2B/230V: 8594030333051  
 PDR-2B/UNI: 8594030333068

Technical parameters	PDR-2/A	PDR-2/B
Function:	16	10
Supply terminals:	A1 - A2	
Voltage range:	AC/DC 12 - 240 V (AC 50/60 Hz)	
Burden (max.):	AC 0.5 - 2.5 VA/DC 0.4 - 2.5 W	
Voltage range:	AC 230 V (50/60 Hz)	
Consumption (apparent/loss):	AC max. 16 VA/2.5 W	
Max. dissipated power (Un + terminals):	5.5 W	
Supply voltage tolerance:	-15 %; +10 %	
Time ranges:	0.01 s - 100 h	
Repeat accuracy:	0.2 % - set value stability	
Temperature coefficient:	0.01 %/°C, at = 20 °C (0.01 %/°F, at = 68 °F)	
<b>Output</b>		
Number of contacts:	2x changeover/SPDT (AgNi/Silver Alloy)	
Current rating:	16 A/AC1	
Breaking capacity:	4000 VA/AC1, 384 W/DC	
Inrush current:	30 A/< 3 s	
Switching voltage:	250V AC/24V DC	
Output indication:	red LED	
Mechanical life:	30.000.000 operations	
Electrical strength (AC1):	70.000 operations	
<b>Control</b>		
Control input Burden:	AC 0.01 - 0.25 VA (UNI), AC 0.25 VA (AC 230 V)	
Glow lamps:	No	
Control. impulse length:	min. 1 ms/max. unlimited	
Reset time:	max. 200 ms	
Display - colour:	red	
Number and height of digits:	4 positions with separating colon, height 10 mm (0.39")	
Luminance:	2200 - 3800 ucd	
Light wavelength:	635 nm	
Brightness setting:	range 20 - 100 % in 10 steps adjustable	
Memory - memory locations:	30 (PDR-2/A)/20 (PDR-2/B) for times ranges + service function	
Data stored for:	min. 10 years	
<b>Other information</b>		
Operating temperature:	-20 °C to +55 °C (-4 °F to 131 °F)	
Storage temperature:	-30 °C to +70 °C (-22 °F to 158 °F)	
Dielectric strength:	4 kV (supply - output)	
Operating position:	any	
Mounting:	DIN rail EN 60715	
Protection degree:	IP40 from front panel/IP20 terminals	
Overvoltage category:	III.	
Pollution degree:	2	
Max. cable size (mm <sup>2</sup> ):	solid wire max. 1x 2.5 or 2x 1.5/ with sleeve max. 1x 1.5 (AWG 12)	
Dimensions:	90 x 52 x 65 mm (3.5" x 2" x 2.6")	
Weight:	142 g (5 oz.) (230), 140 g (4.9 oz.) (UNI)	
Standards:	EN 61812-1	

- Multifunction programmable digital relay with 4 digit red LED display.
- Control and setting are done by 3 buttons, user-friendly menu, absolute accuracy in timer setting, time countdown on a display, galvanically separated START and STOP control inputs with UNI supply.
- Thanks to its complexity, it is possible to program also more demanding time functions by using 2 independent times.
- 2 independent times, with combination of 2 inputs and 2 outputs.
- PDR-2/A: 16 functions, choice of functions of the other relay, 30 memory places for most frequently used times.
- PDR-2/B: 10 functions, 1 output of 10 functions can be assigned to each relay = 2 relays in one device.
- 2 independent times in range: 0.01 s - 100 hrs.

## Description

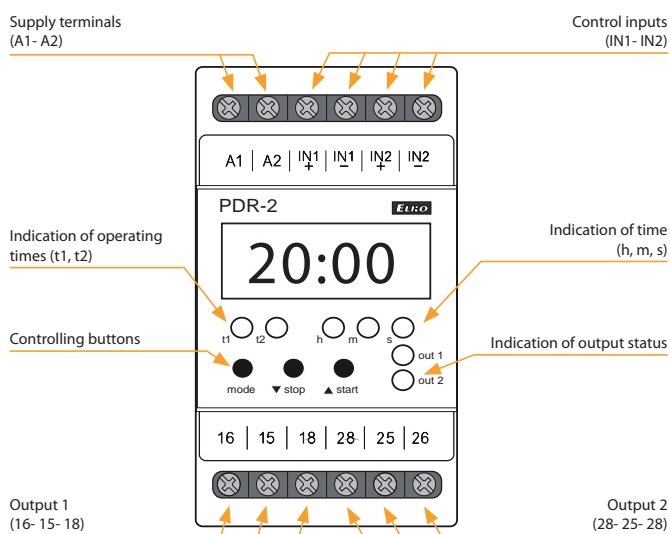

## Symbol

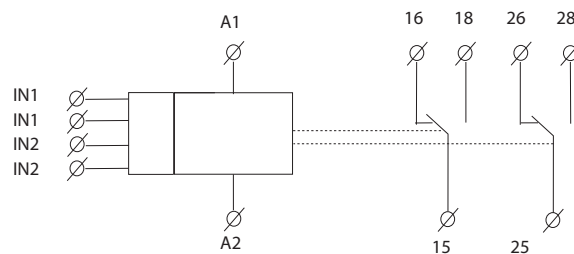

## Time data

Time range:	0.01 s - 99 h 59 min 59 sec 99 ss
Minimal time step:	0.01 s
Time deviation:	0.01 % of set value
Setting error:	0 %
Setting, reset accuracy:	100 %
Digital places:	selected via program

Connection

PDR-2/A

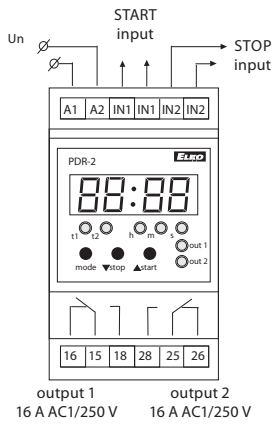

PDR-2/B

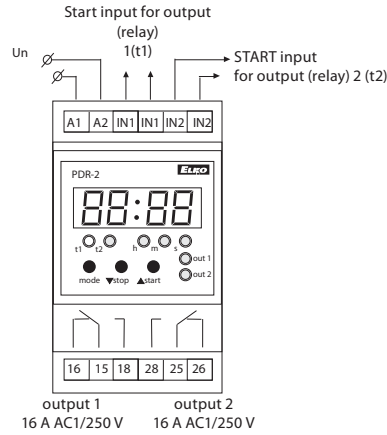

Function

Functions for PDR-2/A and PDR-2/B

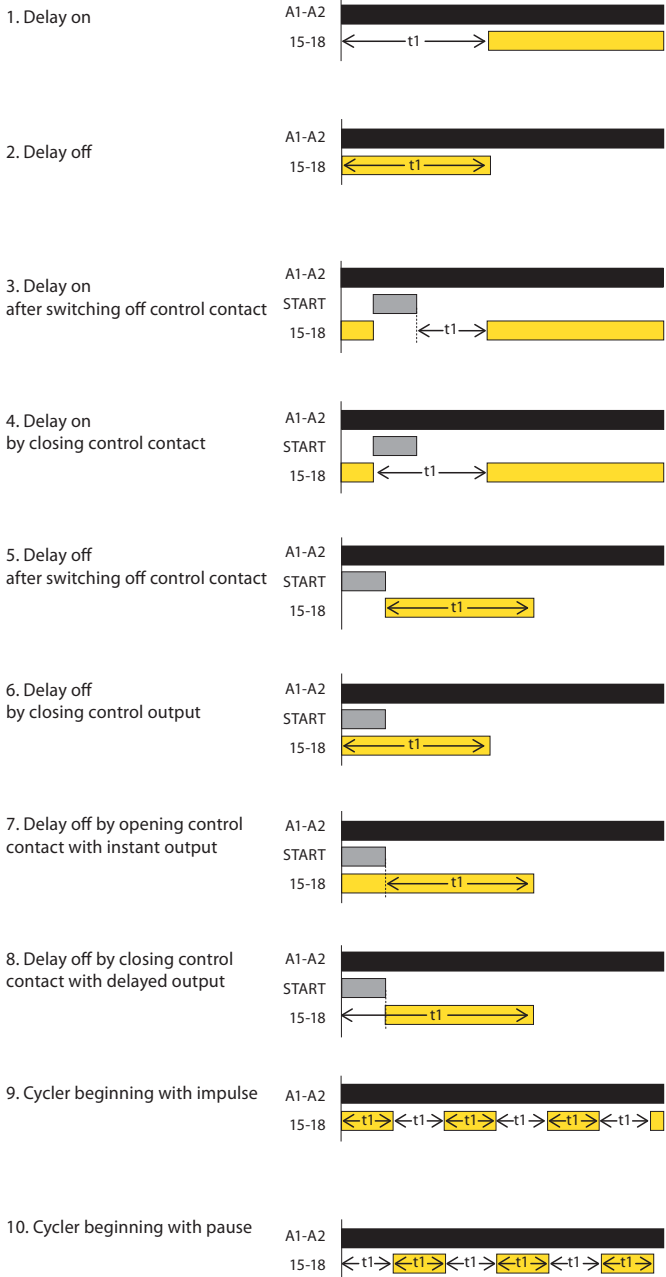

Functions for PDR-2/A

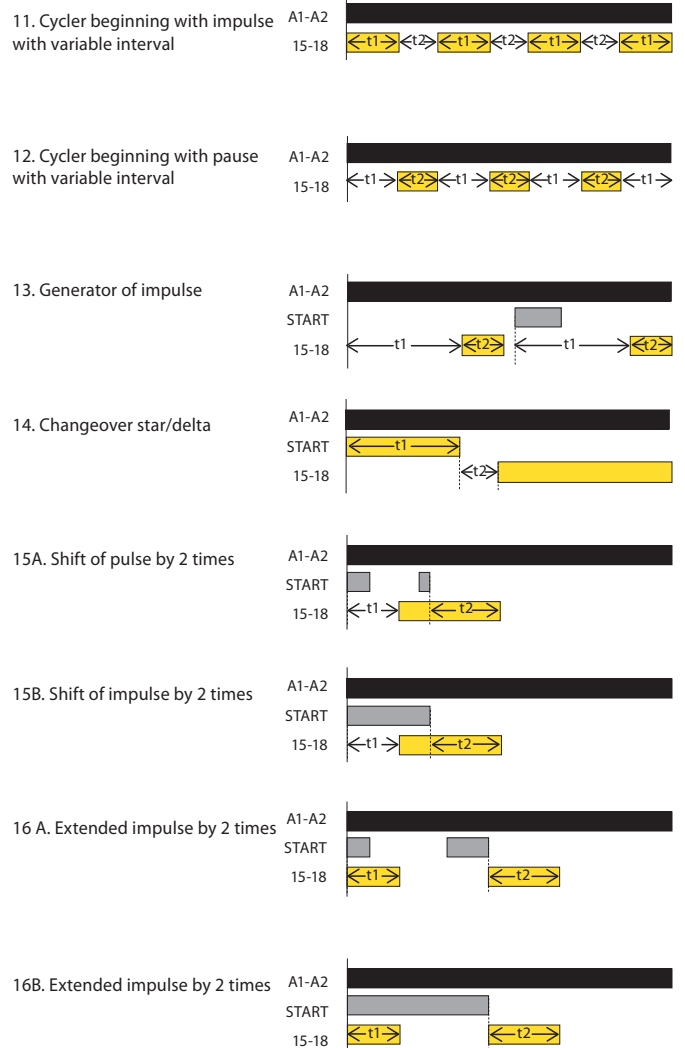

Recommendation:  
PDR-2/B is replacing by 2 simple time relays = 2 in one.

NEW



EAN code  
CRM-46: 8595188174916

Technical parameters		CRM-46
Number of functions:		6
Supply terminals:		A1 - A2
Supply voltage:		AC 230 V (50/60 Hz)
Consumption max.:		3 VA/1.6 W
Max. dissipated power (Un + terminals):		4 W
Supply voltage tolerance:		-15 %; +10 %
Supply indication:		green LED
Time ranges:		0.5 - 10 min
Time setting:		potentiometer
Time deviation:		5 % - mechanical setting
Repeat accuracy:		5 % - set value stability
Temperature coefficient:		0.01 %/°C, at = 20 °C (0.01 %/°F, at = 68 °F)
Output		
Number of contacts:		1x NO - SPST (AgSnO <sub>2</sub> ), switches potential A1
Current rating:		16 A/AC1
Breaking capacity:		4000 VA/AC1, 384 W/DC
Inrush current:		30 A/< 3 s
Switching voltage:		250V AC/24V DC
Output indication:		red LED
Mechanical life:		10.000.000 operations
Electrical life (AC1):*		50.000 operations
Control		
Control voltage:		AC 230 V
Power the control input max.:		4.5 VA/0.3 W
Glow tubes connctions:		Yes
Max. Current of connected glow lamps:		100 mA
Control. terminals:		A1-S or A2-S
Impulse length:		min. 40 ms/max. unlimited
Reset time:		max. 320 ms
Other information		
Operating temperature:		-20 °C to +55 °C (-4 °F to 131 °F)
Storage temperature:		-30 °C to +70 °C (-22 °F to 158 °F)
Operating position:		any
Mounting:		DIN rail EN 60715
Protection degree:		IP40 from front panel/IP10 terminals
Overvoltage cathegory:		III.
Pollution degree:		2
Max. cable size (mm <sup>2</sup> ):		solid wire max. 2x 2.5 or 1x 4 / with sleeve max. 1x 2.5 or 2x 1.5, (AWG 12)
Dimensions:		90 x 17.6 x 64 mm (3.5" x 0.7" x 2.5")
Weight:		56 g (2 oz.)
Standards:		EN 61812-1

\* For higher loads and frequent switching, it is recommended to strengthen the relay contact with a power contactor, e.g. the VSxxx contactor.

- Staircase switch enables delayed switching off of lighting on stairs, corridors, entrances, common areas or for delayed running of fans in the toilet or bathroom.
- The intelligent staircase switch offers similar application possibilities as the CRM-4, while it is possible to extend the delay for functions a, b repeatedly by briefly pressing the control button (s). Each short press multiplies the time set by the potentiometer, i.e. setting the potentiometer to 2 minutes with three presses extends the delay up to 6 minutes. The maximum value of such an extended delay will always be 30 minutes, regardless of the number of presses.
- Long press (>2 s) can switch off the output prematurely and end the on-going delay.
- Control input with the possibility of loading up to 100 mA load (glim lamp, LED in the button, etc.).
- Function (selectable by potentiometer on the front panel)
  - a – STAIRCASE SWITCH, programmable with signalization
  - b – STAIRCASE SWITCH, programmable without signalization
  - c – MEMORY LATCH (press to switch on, press to switch off)
  - d – MEMORY LATCH with delay
- ON (permanently closed) - e.g. during cleaning, moving
- OFF (permanently open) - e.g. when replacing luminaires
- Adjustable time range 0.5 to 10 minutes.
- Handles surge currents up to 80A.
- 3-wire or 4-wire connection (input S can be controlled by potential A1 or A2).

### Description

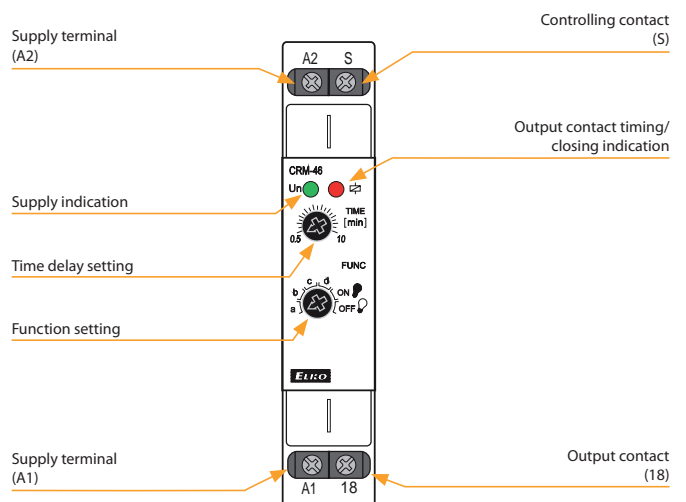

### Circuit connection

3-wire connection

4-wire connection

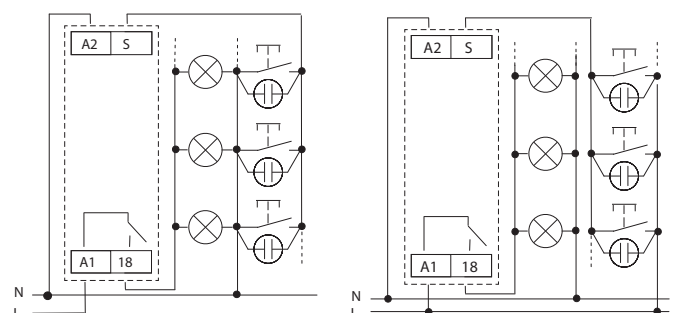

Function

When switching between functions, the red LED flashes.

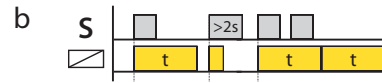
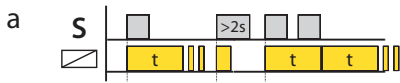

**STAIRCASE SWITCH, programmable with signalization**

The device times the set time, 30 and 40s before the end of the time by double flashing of the luminaire announces the impending switch-off. You can increase the time interval by briefly pressing the button repeatedly. Suitable for resistive loads (e.g. bulbs).

**STAIRCASE SWITCH, programmable without signalization**

The device will time the set time without flashing at the end of the interval. You can increase the time interval by briefly pressing the button repeatedly. The function is suitable for loads that can withstand frequent switching on and off (eg energy saving lamps, LED bulbs).

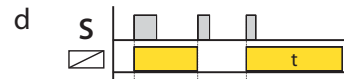
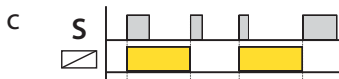

**MEMORY LATCH (press to switch on, press to switch off)**

By pressing the button the output relay closes and by pressing again the relay opens. This function is primarily intended for locations where long-term lighting (without timing) is desirable and the unit is controlled from multiple locations (e.g. in office buildings).

**MEMORY LATCH with delay**

Pressing the button switches the output on/off. If the output is not turned off during the set time "t", it turns off automatically after the timer. This function is suitable for places where lighting is often forgotten (e.g. toilets, corridors, cellars).

NEW



EAN code  
CRM-4: 8595188170772

Technical parameters		CRM-4
Number of functions:	3	
Supply terminals:	A1 - A2	
Supply voltage:	AC 230 V (50/60 Hz)	
Consumption max.:	3 VA/1.6 W	
Max. dissipated power (Un + terminals):	4 W	
Supply voltage tolerance:	-15 %; +10 %	
Supply indication:	green LED	
Time ranges:	0.5 - 10 min	
Time setting:	potentiometer	
Time deviation:	5 % - mechanical setting	
Repeat accuracy:	5 % - set value stability	
Temperature coefficient:	0.01 %/°C, at = 20 °C (0.01 %/°F, at = 68 °F)	
Output		
Changeover contacts:	1x changeover (AgSnO <sub>2</sub> )	
Rated current:	16 A/AC1	
Switching capacity:	4000 VA/AC1, 384 W/DC	
Inrush current:	30 A/<3 s	
Switching voltage:	250V AC/24V DC	
Output indication:	red LED	
Mechanical life:	10.000.000 operations	
Electrical life (AC1):	50.000 operations	
Control		
Control voltage:	AC 230 V	
Power on input max.:	4.5 VA/0.3 W	
Control. terminals:	A1-S or A2-S	
Glow-tubes:	yes	
Max. Current of connected glow lamps:	100 mA	
Impulse length:	min. 40 ms/max. unlimited	
Reset time:	max. 320 ms	
Other information		
Operating temperature:	-20 °C to +55 °C (-4 °F to 131 °F)	
Storage temperature:	-30 °C to +70 °C (-22 °F to 158 °F)	
Dielectric strength:	4 kV (supply - output)	
Operating position:	any	
Mounting:	DIN rail EN 60715	
Protection degree:	IP40 from front panel/IP20 terminals	
Overvoltage category:	III.	
Pollution degree:	2	
Max. cable size (mm <sup>2</sup> ):	solid wire max. 1x 2.5 or 2x 1.5/ with sleeve max. 1x 2.5 (AWG 12)	
Dimensions:	90 x 17.6 x 64 mm (3.5" x 0.7" x 2.5")	
Weight:	56 g (2 oz.)	
Standards:	EN 61812-1	

- Simple staircase switch used to control lighting in corridors, halls, staircases, common areas.
- Can also be used for delayed fan run-out e.g. in bathrooms, toilets, ....
- 3 functions:
  - ON (permanently closed) - e.g. when cleaning, moving
  - AUTO - STAIRCASE SWITCH without signalization
  - OFF (permanently open) - e.g. when replacing lights.
- Adjustable time range 0.5 to 10 minutes.
- Timing can be terminated by long pressing the control button (>2s). Possibility to connect control buttons with glow lamps (max. 100mA).
- Handles surge currents up to 80 A.
- 3-wire or 4-wire connection (input S can be controlled by potential A1 or A2).

## Description

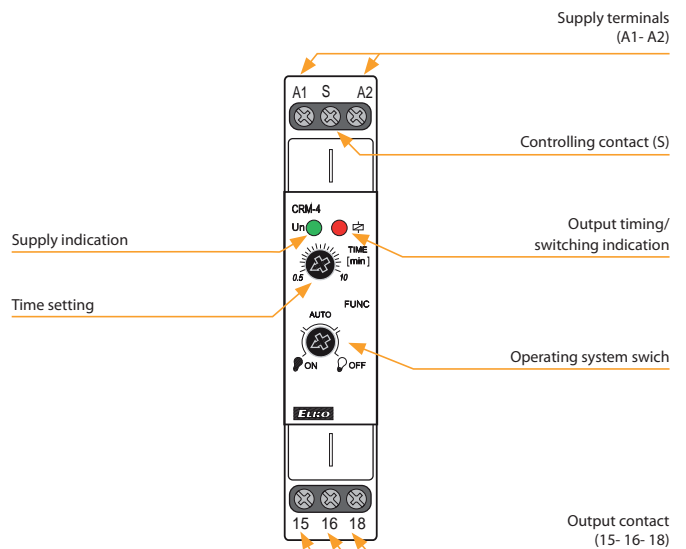

## Circuit connection

### 3-wire connection

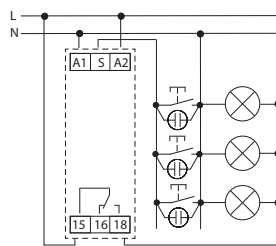

### 4-wire connection

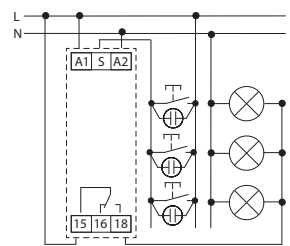

## Function

When switching between functions, the red LED flashes.

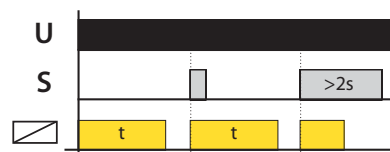

### AUTO - STAIRCASE SWITCH without signalization

By briefly pressing the control button, the device times the set time. You cannot extend the time interval by briefly pressing the button repeatedly. Function suitable for resistive loads (e.g. bulbs) and loads that do not tolerate frequent switching on and off (e.g. energy saving lamps).

### Notice:

- After the supply voltage has been connected, the device always performs 1 time cycle.
- The control input reacts to the potential of terminals A1 and A2.







EAN code  
 SMR-K/230 V: 8595188145176  
 SMR-T/230 V: 8595188129107  
 SMR-H/230 V: 8595188129114  
 SMR-B/230 V: 8595188135566

Technical parameters	SMR-K	SMR-T	SMR-H	SMR-B
Number of functions:	9		10	
Connection:	3-wire, without neutral		4-wire, with neutral	
Voltage range:	AC 230 V (50/60 Hz)			
Power input (no operation/make):	max. 0.8/3 VA		max. 1/1 VA	
Supply voltage tolerance:	-15 %; +10 %			
Time ranges:	0.1 s - 10 days			
Time setting:	via rotaty switch			
Time deviation:	10 % - mechanical setting			
Repeat accuracy:	2 % - set value stability			
Temperature coefficient:	0.1 %/°C, at = 20 °C (0.1 %/°F, at = 68°F)			
<b>Output</b>				
Number of contacts:	1 x triac		1x NO-SPST (AgSnO <sub>2</sub> )	
Resistive load:	10 - 160VA		16A 125/250 V AC1	
Inductive load:	4 W		4 W (cos φ > 0.4)	
<b>Control</b>				
Control voltage:	AC 230 V		AC 230V, UNI 5-250V AC/DC	
Control current:	25µA		3 mA	
Impulse length:	min. 50 ms/max. unlimited			
Glow tubes connctions:	x		Yes	
Max. amount of glow lamps connected to controlling input:	x		230 V - max. amount 50 pcs (measured with glow lamp input: 0.68 mA/230 V AC)	
<b>Other information</b>				
Operating temperature:	0 to +50 °C (+32 to +122 °F)			
Operating position:	any			
Mounting:	free at connecting wires			
Protection degree:	IP 30 in standard conditions*			
Overvoltage category:	III.			
Pollution degree:	2			
Fuse:	F 1 A/250 V		x	
Connection wires (cross-section/length):	3x CY, 0.75 mm <sup>2</sup> (AWG 18) 90 mm (3.5")		4x sol. wir., 0.75 mm <sup>2</sup> (AWG 18) 90 mm (3.5")	
Glow-lamps in control button:	x		max. 10	
Dimensions:	49 x 49 x 13 mm (1.9" x 1.9" x 0.5")		49 x 49 x 21 mm (1.9" x 1.9" x 0.8")	
Weight:	27 g(0.95 oz.)		28 g(0.98 oz.)	
Standards:	EN 61812-1			

\* for more information see page 75

- Multifunction relay designed for installation into a wiring box or under wall-switch in an existing electrical installation.
- Advantageous and fast solution for exchanging standard wall-switch for a switch controlled by time or for an impulse relay controlled by a button.
- **SMR-K**
  - 3-wire connection, works without the connection of a neutral conductor
  - power output: 10-160 VA
  - for flawless function of the product is necessary the presence of a load R, L or C between input S and neutral wire
- **SMR-T**
  - 3-wire connection, works without the connection of a neutral conductor
  - power output: 10 - 160 VA
  - between input S and neutral wire is possible connect any load R, L, or C - that is not necessary (unlike SMR-K)
- **SMR-H**
  - 4-wire connection
  - power output: 0 - 200 VA
- **SMR-B**
  - 4-wire connection
  - output contact 1x 16 A/4000 VA, 250 V AC1
  - enables switching of fluorescent lights and also energy saving lights
  - independent galvanically separated input AC/DC 5 - 250 V, for example for control from a security system

## Description

### SMR-H

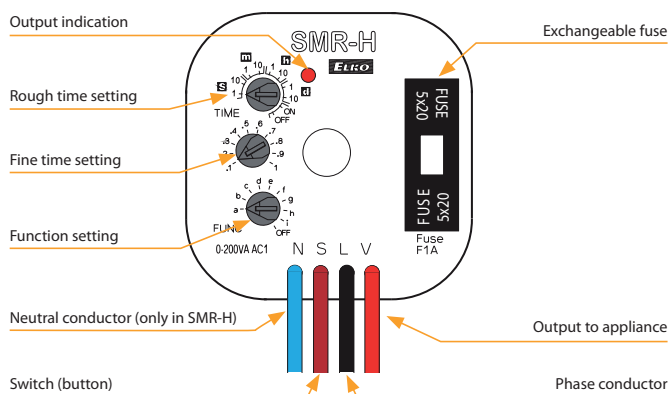

### SMR-B

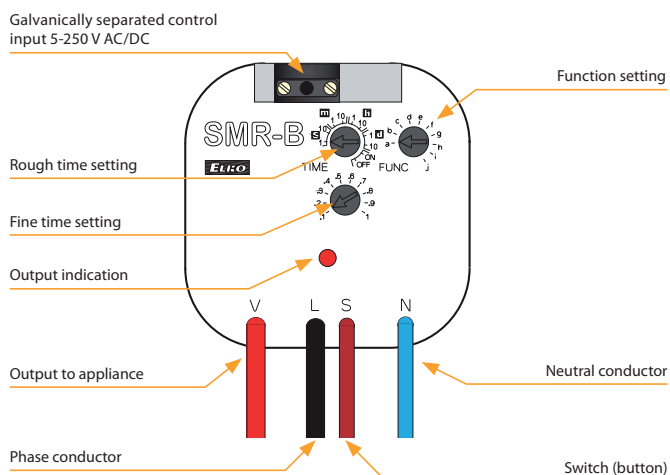

Function

**Function a - delay off on entering edge**

output times when it is switched. Each following pressing (max. 5x) increases time. Long pressing swithes output off



**Function b - delay off on downward edge**

output times after button is switched off, switches immediately



**Function c - delay off on downward edge**

after switching off output switches on and times.



**Function d - cycler - flasher impulsem**

output cycles in regular interval, cycler starts with an impulse



**Function e - puls shift**

delay on after the switch is switched on and delay on after it is switched off



**Function f - delay on**

delay on after switch is switched on until it is switched off

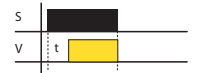

**Function g - impulse relay**

switches on by a press, another pressing switches the output off. The length of pressing doesn't matter, it is possible to set reaction delay by a potentiometer and thus eliminate rebound of a button

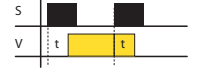

**Function h - impulse relay with delay**

one press switches on, another one switches the output off in case it is done before the end of timing

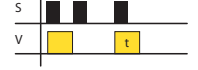

**Function i - cycler starting with pause**

output cycles in regular intervals, cycler starts with a pause



**Function j\* - cycler starting with gap**

delay ON until switched off until it is de-energized or a switch is pressed again.

Note.: \*- Function j is valid only for SMR-B



Connection SMR-K, SMR-T, SMR-H, SMR-B

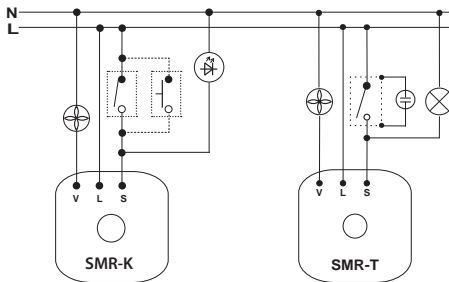

Typical wiring of SMR-K - timer for fan

SMR-T: Fan controlling depending on the lighting

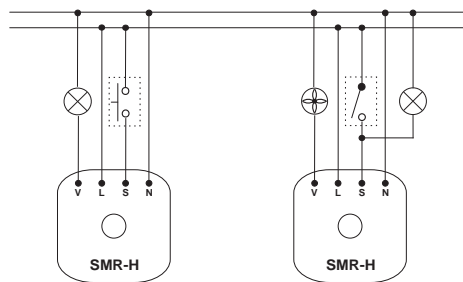

Typical wiring of SMR-H - timer for lamp

Fan control depending on the lighting

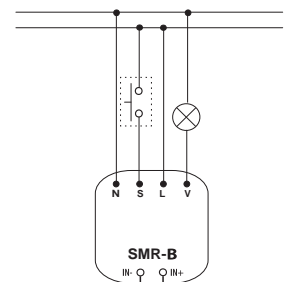

Input for external control voltage AC/DC 5-250 V

Note: SMR-K, SMR-T, SMR-H are not intended for switching capacity load (energy saving bulbs and LED lights with capacity power etc.), these products are only intended for switching resistive and inductive loads (incandescent bulbs, fans, etc.). SMR-B with relay output is intended to other types of load. Using this output it is possible to switch the load of R, L or C-values listed in the load table. Between inputs S and neutral wire is possible to connect any load of R, L or C, however this is not (unlike the SMR-K) condition.

Example of connection SMR-T

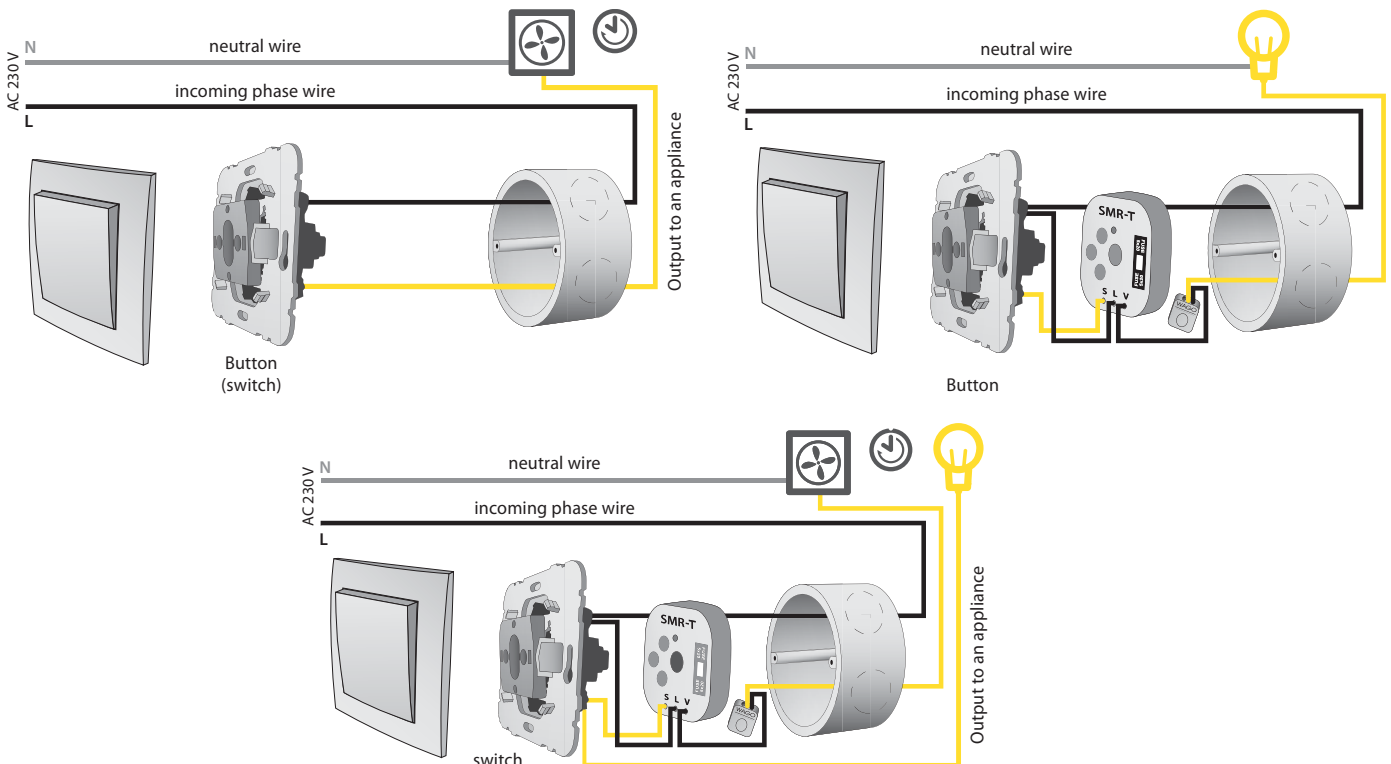

Digital

Analog



**SHT-1**

SHT-1: time switch with daily, weekly programming. 1-channel, output 16 A changeover/SPDT. SHT-1/2: as SHT-1, but 2-channel. page 45



**SHT-1/2**



**SHT-3**

As SHT-1 but with daily, weekly, monthly, and yearly programming up to 2095. SHT-3/2: as SHT-3, but 2-channel. page 45



**SHT-3/2**



**ATS-1DR**

Time switch with daily program, power backup 100h, 1x switch contact 16A page 48



**ATS-2D**

Time switch with daily program, 1x switch contact 16A page 49



**ATS-2DR**

Time switch with daily program power backup 150h, 1x switch contact 16A page 49



**ATS-2WR**

Time switch with weekly program, power backup 150h, 1x switch contact 16A page 49

With astronomical program



**SHT-4**

Time switch with an astronomical program to control the lighting without using a light sensor. 2-channel. page 46

With time synchronization



**SHT-6**

Time switch with DCF managing. Daily, weekly and yearly program, output 16 A. 1-channel. page 46



**DCFR-1**

Universal DCF module, which is designed for controlling the SHT-6 timer, and other devices page 47

With NFC communication



**SHT-7**

Time switch with weekly and yearly program. Setting up with a smartphone supporting NFC transfer page 46

Accessories for SHT-4, SHT-6, SHT-7



**Plug-in module**

Suitable for backup battery type CR2032 (3V) EAN code: 209930603123

Type	Design	Power voltage	Output contact				Program				Options				Specification	Page in the catalogue	
			1chanal 1x 16 A switching AgSnO2	2 chanal, 2x 16 A switching AgSnO2	1 chanal, 1x 16 A switching AgNI	1 chanal, 1x 16 A switching AgNI	Day	Week	Year	Astro	Auto.winter /summer time transition *	Cyclic / pulse output	Replaceable battery	DCF receiver connection (DCFR-1)			Communication via NFC (Android)
SHT-1	2M	AC/DC 12 - 240 V, AC 230 V	●	x	x	x	●	●	x	x	●	●	x	x	x	Time switch for the needs of controlling the connected device according to the user-set program and time, in addition with pulse/cyclic output mode.	45
SHT-1/2	2M	AC/DC 12 - 240 V, AC 230 V	x	●	x	x	●	●	x	x	●	●	x	x	x		
SHT-3	2M	AC/DC 12 - 240 V, AC 230 V	●	x	x	x	●	●	●	x	●	●	x	x	x		
SHT-3/2	2M	AC/DC 12 - 240 V, AC 230 V	x	●	x	x	●	●	●	x	●	●	x	x	x		
SHT-4	2M	AC 230 V	x	●	x	x	●	x	●	●	●	x	●	x	x	Time switch with astronomical program is used to control the connected device according to sunrise and sunset by entering geographical coordinates (or by selecting the city).	46
SHT-6	2M	AC 230 V	●	x	x	x	●	x	●	x	●	●	●	x	Time switch with DCF support is suitable for objects where it is necessary to synchronize the time. This prevents and eliminates errors and inaccuracies.		
SHT-7	2M	AC 230 V	x	●	x	x	●	x	●	x	●	x	●	●	NFC- enabled switch clock provides convenience and time savings during setup.		
AST-1DR	1M	AC 230V	x	x	●	x	●	x	x	x	x	x	x	x	Daily program, minimum switching interval 15 min, power backup (up to 100 hours).	48	
ATS-2D	2M	AC 230V	x	x	x	●	●	x	x	x	x	x	x	x	Daily program, minimum switching interval 30 min, without power backup.	49	
ATS-2DR	2M	AC 230V	x	x	x	●	●	x	x	x	x	x	x	x	Daily program, minimum switching interval 30 minutes, power backup (up to 150 hours).		
ATS-2WR	2M	AC 230V	x	x	x	●	x	●	x	x	x	x	x	x	Weekly program, minimum switching interval 3.5 hours, power backup (up to 150 hours).		

\*default settings (can be changed)



EAN code  
 SHT-1/230V: 8595188130424  
 SHT-1/UNI: 8595188130431  
 SHT-1/2/230V: 8595188130400  
 SHT-1/2/UNI: 8595188130417  
 SHT-3/230V: 8595188136761  
 SHT-3/UNI: 8595188136754  
 SHT-3/2/230V: 8595188129015  
 SHT-3/2/UNI: 8595188129046

Technical parameters	SHT-1, SHT-3	SHT-1/2, SHT-3/2
Supply terminals:	A1 - A2	
Voltage range:	UNI	AC/DC 12 - 240 V (AC 50/60 Hz)
Burden (max.):		AC 0.5 - 2 VA/DC 0.4 - 2 W
Voltage range:	230	AC 230 V (50/60 Hz)
Burden:		AC max. 14 VA/2 W
Max. dissipated power (Un + terminals):	3.5 W	5 W
Supply voltage tolerance:	-15 %; +10 %	
Back-up supply:	yes	
Summer/winter time:	automatic	
<b>Output</b>		
Number of contacts:	1x changeover/SPDT (AgSnO <sub>2</sub> )	2x changeover/SPDT (AgSnO <sub>2</sub> )
Current rating:	16 A/AC1	
Breaking capacity:	4000 VA/AC1, 384 W/DC	
Inrush current:	30 A/< 3 s	
Switching voltage:	250V AC/24V DC	
Mechanical life:	> 30.000.000 operations	
Electrical life (AC1):	> 70.000 operations	
<b>Time circuit</b>		
Power back-up:	up to 3 years	
Accuracy:	max. ±1s/day at 23 °C (73.4 °F)	
Minimum interval:	1 min	
Data stored for:	min. 10 years	
Cyclic output:	1 - 99 s	
Pulse output:	1 - 99 s	
<b>Program circuit</b>		
Number of memory places:	100	
Program (SHT-1; SHT-1/2):	daily, weekly	
Program (SHT-3; SHT-3/2):	daily, weekly, monthly, yearly (up to year 2095)	
Data readout:	LCD display, with back light	
<b>Other information</b>		
Operating temperature:	-20 °C to +55 °C (-4 °F to 131 °F)	
Storage temperature:	-30 °C to +70 °C (-22 °F to 158 °F)	
Dielectric strength:	4 kV (supply - output)	
Operating position:	any	
Mounting:	DIN rail EN 60715	
Protection degree:	IP10 clips, IP40 from front panel	
Overvoltage category:	III.	
Polution degree:	2	
Max. cable size (mm <sup>2</sup> ):	solid wire max. 2x 2.5 or 1x 4 with sleeve max. 1x 2.5 or 2x 1.5 (AWG 12)	
Dimensions:	90 x 35 x 64 mm (3.5" x 1.4" x 2.5")	
Weight:	(UNI) - 117 g (4.13 oz.), (230) - 115 g (4.06 oz.)	(UNI) - 132 g (4.7 oz.), (230) - 128 g (4.5 oz.)
Standards:	EN 61812-1	

- This time switch clock SHT is used to control various appliances in real time; daily, weekly, monthly and yearly mode.
- Switching: according the program (AUTO)/constantly manually, manually to next program change/random (CUBE).
- „Holiday program“ option to choose an interval when the device doesn't switch according to the standard program, but will be block during that time.
- Automatic conversion summer/winter time.
- Sealable cover of front panel, easy controlling via 4 buttons.
- Cyclic output.
- Pulse output.

Description

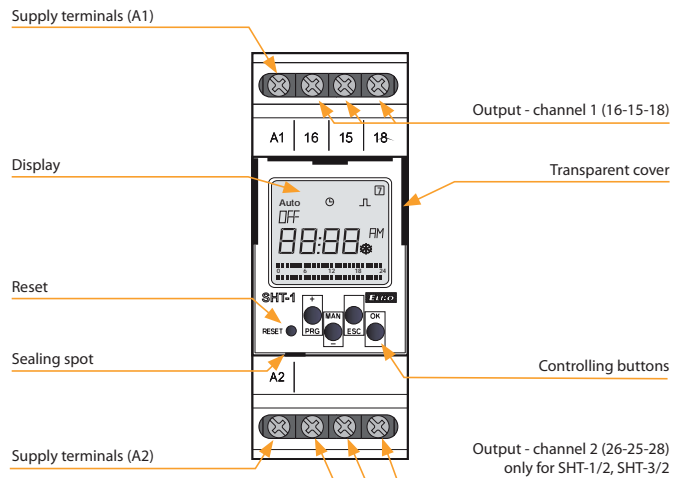

Description of displayed elements on the screen

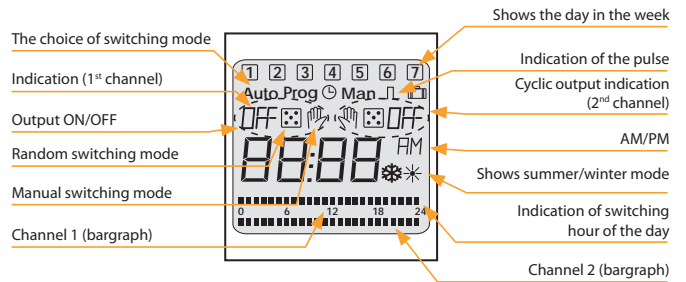

Connection

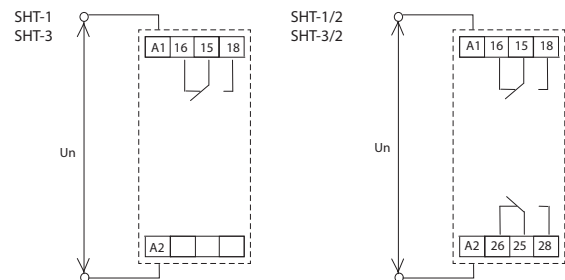

Symbol

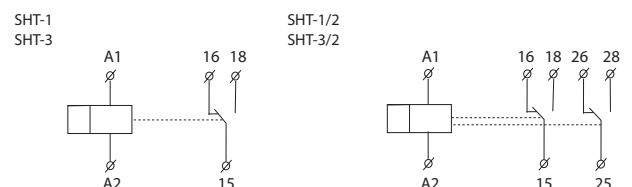



EAN code

SHT-4: 8595188144759  
 SHT-6 + DCFR-1: 8595188148382  
 SHT-7: 8595188135498

Technical parameters	SHT-4	SHT-6	SHT-7
Power supply terminals:	A1 - A2		
Supply voltage:	AC 230 V (50/60 Hz)		
Input power:	AC max. 14VA/2W	8 VA/0.7 W	AC max. 14VA/2W
Max. dissipated power (Un + terminals):	5 W	3.5 W	5 W
Supply voltage tolerance:	-15 %; +10 %		
Real time back-up:	yes		
Backup battery type	CR 2032 (3V)		
Transition to summer/winter time:	automatic		
<b>Output</b>			
Number of contacts:	2x changeover SPDT (AgSnO <sub>2</sub> )	1x changeover (AgSnO <sub>2</sub> )	2x changeover SPDT (AgSnO <sub>2</sub> )
Rated current:	16 A/AC1		
Switching power:	4000 VA/AC1, 384 W/DC		
Peak current:	30 A/< 3 s		
Switching voltage:	250V AC/24V DC		
Mechanical service life:	> 30.000.000 operations		
Electrical service life (AC1):	> 70.000 operations		
<b>Timing circuit</b>			
Real time backup:	up to 3 years		
Accuracy of operation:*	max. ±1 s per day, at 23°C (73 °F)		
Minimum triggering interval:	1 minute		
Program data storage period:	10 years at minimum		
<b>Programming circuit</b>			
Number of memory locations:	100		
Program:	daily, yearly		
NFC interface:	x	x	daily, yearly
Data display:	LCD display, backlight		
<b>Other information</b>			
Operating temperature:	-20 to +55 °C (-4 °F to 131 °F)		
Storage temperature:	-30 to +70 °C (-22 °F to 158 °F)		
Dielectric strength:	4 kV (power supply - output)		
Operating position:	any		
Mounting:	DIN rail EN 60715		
Protection degree:	IP10 terminals, IP40 from front panel		
Overvoltage category:	III.		
Pollution degree:	2		
Max. cable size (mm <sup>2</sup> ):	max. 2x 2.5, max. 1x 4 with sleeve max. 1x 2.5, max. 2x 1.5 (AWG 12)		
Dimensions:	90 x 35 x 64 mm (3.5" x 1.4" x 2.5")		
Weight (without battery):	128 g (4.5 oz.)	114 g (4 oz.)	125 g (4.4 oz.)
Standards:	EN 61812-1		

\* SHT-6: without DCF

**Symbol**

- **SHT-4:** Used to control different loads according to sunrise and sunset time based on geographical coordinates:
  - preset coordinates for European cities incl. manual setting options
  - hour meter for each channel
  - two-channel design - each channel is adjustable individually.
- **SHT-6:** Used to control various appliances depending on real time, which is synchronized with the DCF77 signal. This eliminates inaccuracies at the set time.
  - single channel design
  - hour meter.
- **SHT-7:** Used to control various appliances depending on real time, incl. settings via smartphone thanks to NFC transmission support
  - two-channel design - each channel is adjustable individually
  - easy transfer of settings to multiple devices conveniently in the application and, conversely, simple transfer of settings from the timer to the application in the telephone.
- Sealable transparent front panel cover, easy to operate with 4 buttons.
- Real-time backup - up to 3 years with replaceable battery.
- Including daily, weekly, monthly and yearly regimen.
- Automatic winter/summer time changeover.

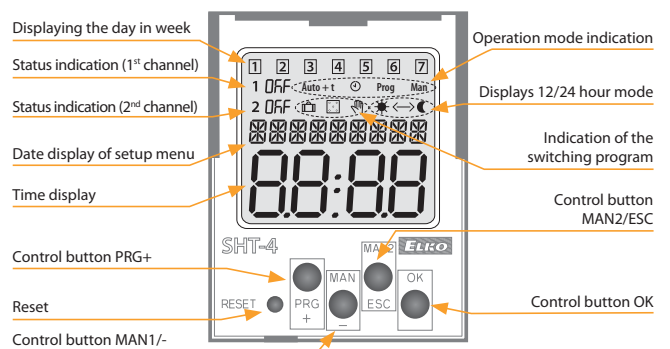
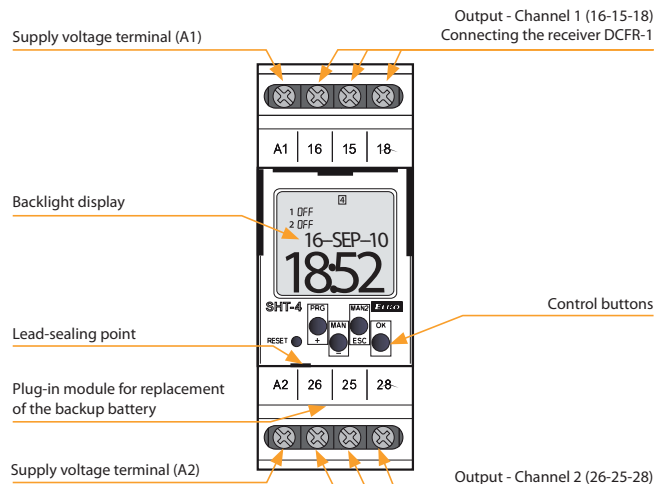
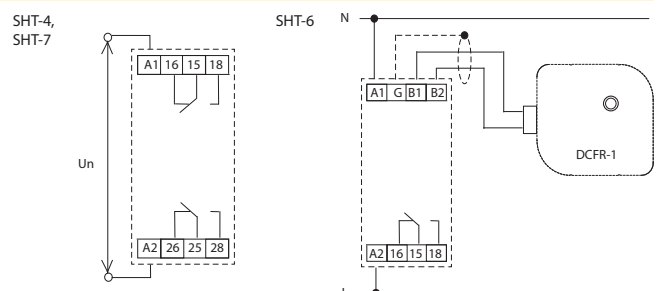
**Description****Wiring**



EAN code  
DCFR-1: 8595188148412

Technical parameters	DCFR-1
Connection:	2 conductors
Max. cross-connection conductors:	2.5 mm <sup>2</sup>
Max voltage on the wires:	10 V
Indication Function:	red LED
Other information	
Storage temperature:	-30 to +70 °C (-22 to 158 °F)
Protection:	IP65
Dimensions:	98 x 62 x 34 mm (39.3" x 2.4" x 1.3")
Weight:	110 g (3.88 oz.)
Operating position:	perpendicular to the direction of reception
The reception area:	about 1500 km from Frankfurt/Main

- Universal DCF module, which is designed for controlling the SHT-6 timer, and other devices.
- Outdoor applications (IP65 protection).
- Two-wire connection - not polarity sensitive!
- Length of connecting cable is up to 100 m (328').
- Visual indication of proper function module.

Description

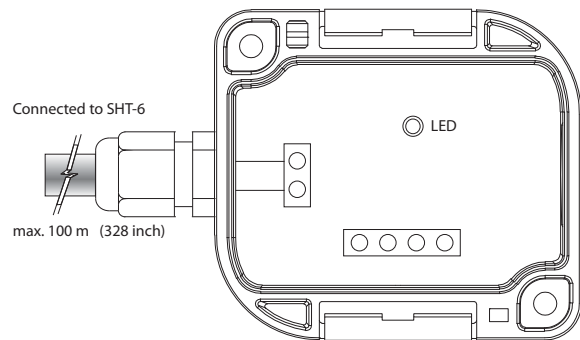

Working position - options





- Mechanical timer is a simple and inexpensive alternative to digital switches for controlling real-time heating, ventilation, cooling, lighting or pump systems:
  - daily program
- Selection of operating modes using a switch on the panel:
  - ☉ switches automatically according to the set program
  - I closes permanently
- Power backup after power failure 100 hours, when fully charged.
- Sealable transparent front panel cover.

Technical parameters	ATS-1DR
<b>Supply</b>	
Supply terminals:	L, N
Supply voltage:	AC 230V (50/60 Hz)
Consumption max:	1W (1,5 VA)
Supply voltage tolerance:	-10%, +10%
<b>Time circuit</b>	
Program:	daily
Number of switching segments:	96
Minimum operating switching time:	15 min.
Operating accuracy:	+/- 3s/day
Power backup:	max. 100h
<b>Output</b>	
Changeover contacts:	1x switch (AgNi)
Rated current:	16A/AC1
Peak performance:	3500VA/AC1
Switching voltage:	250V AC1
Mechanical life:	1.000.000 operations
Electrical life (AC1):	10.000 operations
<b>Other information</b>	
Operating temperature:	-10 to +50°C (14 to 122°F)
Storage temperature:	-10 to +50°C (14 to 122°F)
Dielectric strength:	4kV (supply - output)
Operating position:	any
Mounting:	DIN rail EN 60715
Protection degree:	IP20
Pollution degree:	III.
Pollution degree:	2
Max. cable size (mm <sup>2</sup> ):	max. 1x 4, max. 2x 1.5 with sleeve max. 1x 4, max. 2x 1.5
Dimensions:	90 x 17,5 x 64 mm (3,5" x 0,69" x 2,5")
Weight:	73 g (2,6 oz.)
Standards:	EN 61812-1, EN 60669-1, EN 63044-1

**Description**

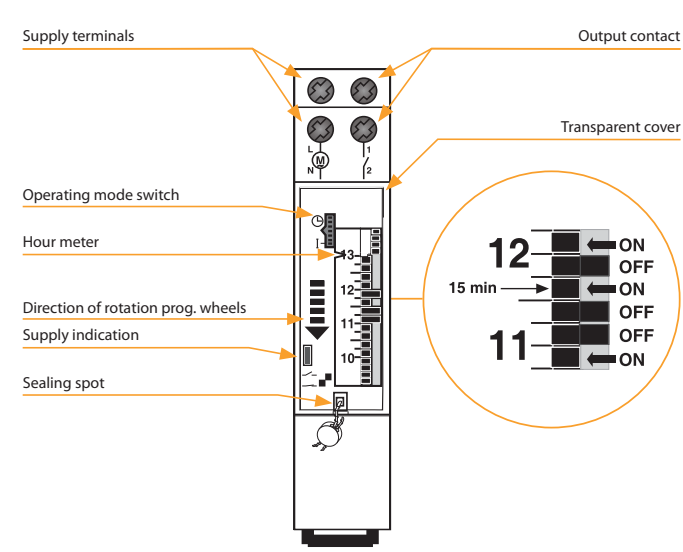

**Circuit connection**

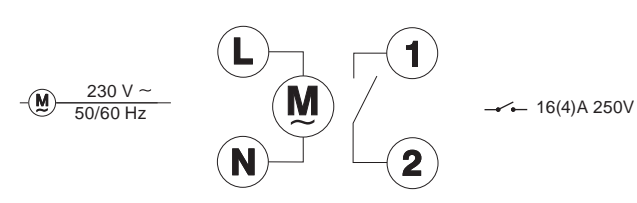





- Mechanical timer is a simple and inexpensive alternative to digital switches for controlling real-time heating, ventilation, cooling, lighting or pump systems:
  - daily or weekly program
- Selection of operating modes using a switch on the panel:
  - I closes permanently
  - O opens permanently
  - ☉ switches automatically according to the set program.
- Power backup after power failure 150 hours, when fully charged.
- Sealable transparent front panel cover.

Technical parameters	AST-2D	AST-2DR	AST-2WR
<b>Supply</b>			
Supply terminals:	4,5		
Supply voltage:	AC 230V (50 Hz)	AC 230V (50/60 Hz)	AC 230V (50/60 Hz)
Consumption max:	1W (1,5 VA)		
Supply voltage tolerance:	-10%, +10%		
<b>Time circuit</b>			
Program:	daily	daily	weekly
Number of switching segments:	48		
Min. operating switching time:	30 min.	30 min	3.5 hrs
Operating accuracy:	+/- 1s/day		
Power backup:	x	max. 150h	
<b>Output</b>			
Changeover contacts:	1x switch (AgNi)		
Rated current:	16A/AC1		
Peak performance:	3500 VA/AC1		
Switching voltage:	250 V AC1		
Mechanical life:	1.000.000 operations		
Electrical life (AC1):	10.000 operations		
<b>Other information</b>			
Operating temperature:	-10 to + 50°C (14 to 122°F)		
Storage temperature:	-10 to +50°C (14 to 122°F)		
Dielectric strength:	4kV (supply - output)		
Operating position:	any		
Mounting:	DIN rail EN 60715		
Protection degree:	IP20		
Pollution degree:	III.		
Pollution degree:	2		
Max. cable size (mm <sup>2</sup> ):	max. 1x 4, max. 2x 1.5		
Dimensions:	90 x 35 x 60 mm (3,5" x 1,4" x 2,4")		
Weight:	117 g (4,1 oz.)		
Standards:	EN 61812-1, EN 60669-1, EN 63044-1		

Description

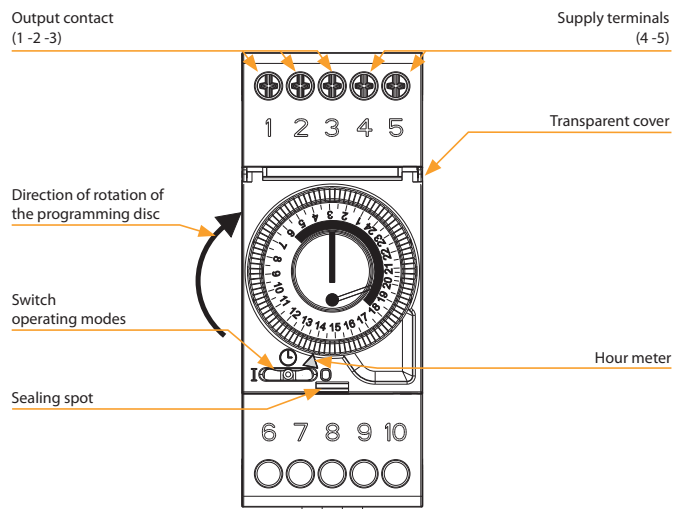

Circuit connection

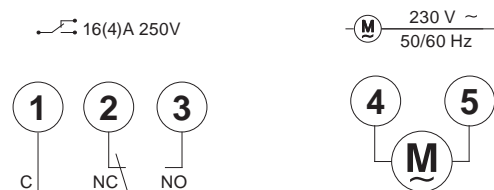

## VS

**VS116B/230**

Supply voltage:  
AC 230 V  
Output contact:  
1x changeover/SPDT 16 A.  
page 51

**VS116K**

Supply voltage:  
AC 230 V and AC/DC 24 V  
Output contact:  
1x changeover/SPDT 16 A.  
page 51

**VS308K**

Supply voltage:  
AC 230 V and AC/DC 24 V  
Output contacts:  
3x changeover/TPDT 8 A.  
page 51

**VS316/24**

Supply voltage: AC/DC 24 V  
Output contacts:  
3x changeover/TPDT  
16 A, possibility to be  
connected into 3-phase  
circuit.  
page 51

**VS316/230**

Supply voltage:  
AC 230 V  
Output contacts:  
3x changeover/TPDT  
16 A, possibility to be  
connected into 3-phase  
circuit.  
page 51

**VS116U**

Supply voltage:  
AC/DC 12-240 V  
Output contact:  
1x changeover/SPDT 16 A.  
page 51

**VS308U**

Supply voltage:  
AC/DC 12-240 V  
Output contacts:  
3x changeover/TPDT 8 A.  
page 51

Type	Design	Coil voltage	Output contact	Other features			Designation	Page of catalogue
				LED signal light	RC unit	Paralel diode		
VS116B/230	MINI	AC 230 V/50-60 Hz	1x16 A changeover/ SPDT	●	x	x	VS116/B230 MINI, with installation into junction box or ceiling that allows control of lights, shades or awnings drives	51
VS116K	1M-DIN	AC 230 and AC/DC 24 V	1x16 A changeover/ SPDT	●	●	●	as a separation relay (4kV), direct switching of appliances up to 4000 VA (e.g. heaters), well visible signalization, noiseless	
VS116U	1M-DIN	AC/DC 12..240 V	1x16 A changeover/ SPDT	●	●	●	as VS116K, but multivoltage supply coil	
VS308K	1M-DIN	AC 230 and AC/DC 24 V	3x 8 A changeover/ TPDT	●	●	●	a "multiplication" of contacts, 3x changeover contact/ 3PDT only in 1-MODULE, well visible signalization, noiseless	
VS308U	1M-DIN	AC/DC 12..240 V	3x 8 A changeover/ TPDT	●	●	●	as VS308K, but multivoltage supply coil	
VS316/24	1M-DIN	AC/DC 24 V	3x16 A changeover/ TPDT	●	●	●	3x changeover contact in 1-MODULE, possibility of "multiplication" of contacts and in the same time possibility of switching high output, possibility of 3 phase switching	
VS316/230	1M-DIN	AC 230 V	3x16 A changeover/ TPDT	●	●	●	as VS316/24, but AC 230 V	



- Power relay used for switching larger load output, strengthen or „multiplying“ contacts of the existing device.
- Relays VS316/24, VS316/230 enable connection to a 3-phase circuit.
- In the design 1-MODULE , DIN rail mounting, output status indicated by high intensity LED with choice of LED color (red, green, blue or white LED\*).
- **VS116B/230** MINI, mounting in installation box or ceilings, enabling switching of lights, motors for blinds or awnings.
- For **VS116B/230** status of output indicated by LED on front panel of device.

Technical parameters	VS116B/230	VS116K	VS116U	VS308K	VS308U	VS316/24	VS316/230
Supply terminals:	L - N			A1 - A2			
Voltage range:	AC 230 V (50/60 Hz)	AC 230 V (50/60 Hz)	AC/DC 12-240 V (50/60 Hz)	AC 230 V (50/60 Hz)	AC/DC 12-240 V (50/60 Hz)	AC/DC 24 V (50/60 Hz)	AC 230 V (50/60 Hz)
Burden (max.):	AC 7.5 VA 1 W	AC 7.5 VA 1 W	AC 0.7 - 3 VA/DC 0.5 - 1.7 W	AC 10.3 VA 1.1 W	AC 0.7 - 3 VA/DC 0.5 - 1.7 W	1.6 VA 1.2 W	2.5 VA
Supply terminals:	x	A1 - A3	x	A1 - A3		x	
Voltage range:	x	AC/DC 24 V (50/60 Hz)	x	AC/DC 24 V (50/60 Hz)		x	
Burden:	x	AC 1 VA/DC 1W	x	AC 1 VA/DC 1W		x	
Supply voltage tolerance:	-15%; +10%						
Max. dissipated power (Un + terminals):	4 W			3 W		8 W	6 W
<b>Output</b>							
Number of contacts:	1 x changeover/SPDT (AgSnO <sub>2</sub> )			3 x changeover/TPDT (AgNi/Silver Alloy)		3 x changeover/TPDT (AgSnO <sub>2</sub> )	
Current rating:	16 A/AC1			8 A/AC1		16A/AC1	
Breaking capacity:	4000VA/AC1, 384W/ DC			2000VA/AC1, 192W/ DC		4000VA/AC1, 384W/DC	
Inrush current:	30 A/<3 s			10 A/<3 s		30 A/<3 s	
Switching voltage:	250V AC/24V DC						
Output indication:	red LED	high intensity of LED					
Mechanical life:	30.000.000 operations					10.000.000 operations	
Electrical life (AC1):	70.000 operations					100.000 operations	
Time between switching:	min. 2s					20 ms	50 ms
<b>Other information</b>							
Operating temperature:	-20 to +55 °C (-4 °F to 131 °F)						
Storage temperature:	-30 to +70 °C (-22 °F to 158 °F)						
Dielectrical strength:	4 kV (supply-output)						
Operating position:	any						
Mounting:	free at connecting wire	DIN rail EN 60715					
Protection degree:	IP30	IP40 from front panel/IP20 terminals					
Overvoltage category:	III.						
Pollution degree:	2						
Max. cable size (mm <sup>2</sup> ):	2x 0.75 mm <sup>2</sup> (AWG 18), 3x 2.5 mm <sup>2</sup> (AWG 10)	max. 1x 2.5 or 2x 1.5 max. 1x 2.5 (AWG 12)					
Dimensions:	49 x 49 x 21 mm (2" x 2" x 0.8")	90 x 17.6 x 64 mm (3.5" x 0.7" x 2.5")					
Weight:	48 g (1.7 oz.)	56 g (2 oz.)	59 g (2.1 oz.)	78 g (2.75 oz.)	80 g (2.8 oz.)	90 g (3.17 oz.)	93 g (3.3 oz.)
Standards:	EN 60669-1, EN 60669-2-1						

Description

VS116K, VS116U

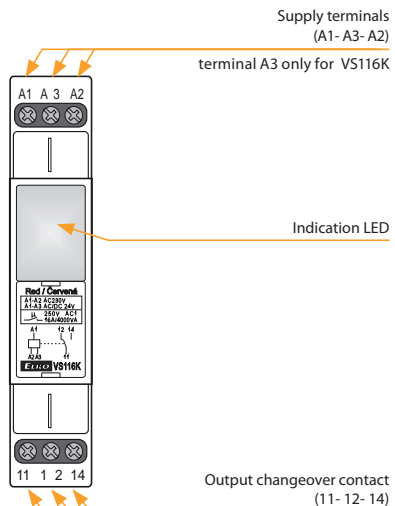

VS308K, VS308U

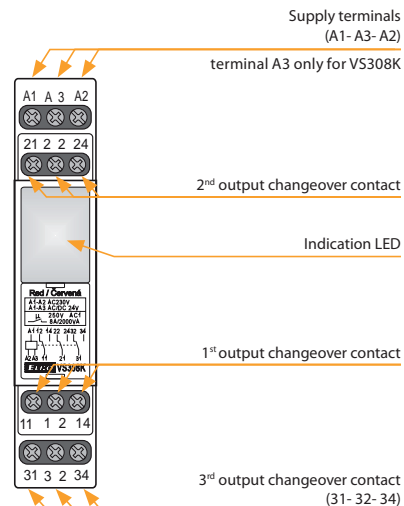

VS316/24, VS316/230

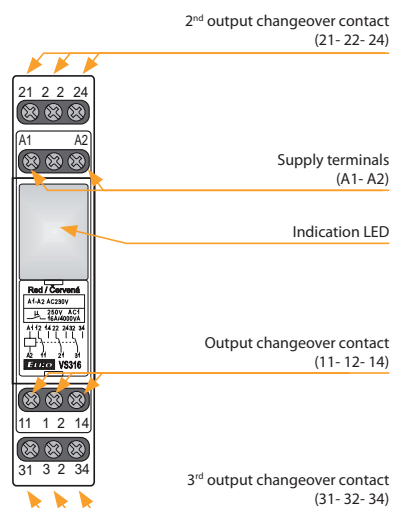

VS116B/230

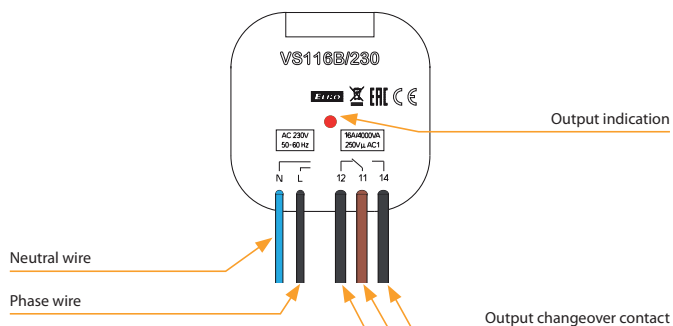

Symbol

VS116B/230

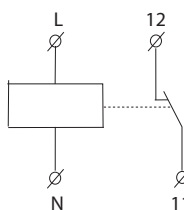

VS116K

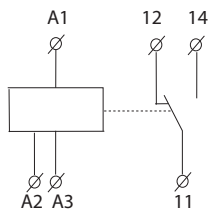

VS116U

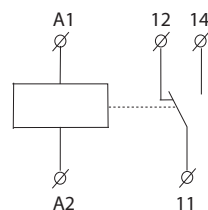

VS308K

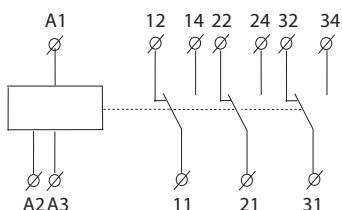

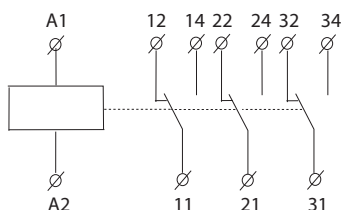

VS308U, VS316/24, VS316/230



EAN codes

VS116B/230	8595188147545				
VS116K/red	8595188122597	VS308K/red	8595188122696	VS316/24 red	8595188135771
VS116K/green	8595188122610	VS308K/green	8595188122719	VS316/24 green	8595188136105
VS116K/white	8595188122573	VS308K/white	8595188122672	VS316/24 white	8595188136099
VS116K/blue	8595188122603	VS308K/blue	8595188122702	VS316/24 blue	8595188136112
VS116U/red	8595188124607	VS308U/red	8595188130103	VS316/230 red	8595188135559
VS116U/green	8595188136433	VS308U/green	8595188136440	VS316/230 green	8595188136075
VS116U/white	8595188138482	VS308U/white	8595188138512	VS316/230 white	8595188136051
VS116U/blue	8595188138475	VS308U/blue	8595188138505	VS316/230 blue	8595188136068

Order code

	<b>VS116K/red:</b> 2295	<b>VS116U/red:</b> 2460	<b>VS308K/red:</b> 2269	<b>VS308U/red:</b> 3010	<b>VS316/24V red:</b> 3577	<b>VS316/230V red:</b> 4471
	<b>VS116K/green:</b> 2261	<b>VS116U/green:</b> 3643	<b>VS308K/green:</b> 2271	<b>VS308U/green:</b> 3644	<b>VS316/24V green:</b> 3610	<b>VS316/230V green:</b> 4472
	<b>VS116K/white:</b> 2257	<b>VS116U/white:</b> 3848	<b>VS308K/white:</b> 2267	<b>VS308U/white:</b> 3851	<b>VS316/24V white:</b> 3609	<b>VS316/230V white:</b> 4470
	<b>VS116K/blue:</b> 2260	<b>VS116U/blue:</b> 3847	<b>VS308K/blue:</b> 2270	<b>VS308U/blue:</b> 3850	<b>VS316/24V blue:</b> 3611	<b>VS316/230V blue:</b> 4474

Notes

Max. time of changeover of contact is 10 ms.

VS316/24 or VS316/230 enables switching of different phases or 3-phase voltage.

\* possibility to choose blue and white color of LED for power relays line VS in case of minimal order quantity 100 pcs.

## Installation contactors VS

**VS120**

Number of contacts:  
1x20 A. Configuration  
of switching and  
breaking contacts:  
10, 01.  
page 55

**VS220**

Number of contacts:  
2x20 A. Configuration  
of switching and  
breaking contacts: 20,  
11, 02.  
page 55

**VS420**

Number of contacts:  
4x20 A. Configuration  
of switching and  
breaking contacts:  
40, 31.  
page 55

**VS425**

Number of contacts:  
4x25 A. Configuration  
of switching and  
breaking contacts:  
40, 31, 22, 04.  
page 55

**VS440**

Number of contacts:  
4x40 A. Configuration  
of switching and  
breaking contacts:  
40, 31, 22, 04.  
page 55

**VS463**

Number of contacts:  
4x63 A. Configuration  
of switching and  
breaking contacts:  
40, 31, 22.  
page 55

## Installation contactors with manual control VSM

**VSM220**

Number of contacts:  
2x20 A. Configuration  
of switching and  
breaking contacts: 20,  
11, 02.  
page 56

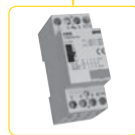
**VSM425**

Number of contacts:  
4x25 A. Configuration  
of switching and  
breaking contacts:  
40, 31, 22, 04.  
page 56

## Accessories

**VSK-11**

Auxiliary contacts:  
1x switching,  
1x breaking.

**VSK-20**

Auxiliary contacts:  
2x switching.



EAN code see page 55

- For switching electric circuits, especially for resistive loads and 3-phase induction motors:  
 number of contacts VS120: 1  
 number of contacts VS220: 2  
 number of contacts VS420, VS425, VS440, VS463: 4.
- It is produced in configuration of switching and breaking contacts:  
 VS120: 10, 01  
 VS220: 20, 11, 02  
 VS420: 40, 31  
 VS425: 40, 31, 22, 13 04  
 VS440: 40, 31, 22, 04  
 VS463: 40, 31, 22.
- Protection IP20 - on request we deliver covers that ensure protection IP40 for all terminals.
- DIN rail or panel mounting.

Technical parameters	VS120	VS220	VS420	VS425	VS440	VS463
Rated insulation voltage (Ui):	230 V	230 V	415 V	440 V	440 V	440 V
Rated thermo-current I <sub>th</sub> (in AC):	20 A	20 A	20 A	25 A	40 A	63 A
<b>Switched operation</b>						
AC-1 for 400 V, 3 phase:	x	x	13 kW	16 kW	26 kW	40 kW
AC-1 for 230 V:	4 kW, 1 phase	4 kW, 1 phase	7.5 kW, 3 phase	9 kW, 3 phase	16 kW, 3 phase	24 kW, 3 phase
AC-3 for 400 V, 3 phase:	x	x	2.2 kW	4 kW	11 kW	15 kW
AC-3 for 230 V:	1.3 kW only NO, 1 phase	1.3 kW only NO, 1 phase	1.1 kW, 3 phase	2.2 kW, 3 phase	5.5 kW, 3 phase	8.5 kW, 3 phase
AC-7a for 400 V, 3 phase:	x	x	13 kW	16 kW	26 kW	40 kW
AC-7a for 230 V:	4 kW, 1 phase	4 kW, 1 phase	7.5 kW, 3 phase	9 kW, 3 phase	16 kW, 3 phase	24 kW, 3 phase
AC-7b for 400 V, 3 phase:	x	x	2.2 kW	4 kW	11 kW	15 kW
AC-7b for 230 V:	1.3 kW only NO, 1 phase	1.3 kW only NO, 1 phase	1.1 kW, 3 phase	2.2 kW, 3 phase	5.5 kW, 3 phase	8.5 kW, 3 phase
AC-15 for 400 V, 1 phase:	4 A	4 A	4 A	4 A	4 A	4 A
AC-15 for 230 V, 1 phase:	6 A	6 A	6 A	6 A	6 A	6 A
DC1 U <sub>e</sub> = 24 V:	20 A	20 A	20 A	25 A	40 A	63 A
DC1 U <sub>e</sub> = 110 V:	6 A	6 A	2 A	6 A	4 A	4 A
DC1 U <sub>e</sub> = 220 V:	0.6 A	0.6 A	0.5 A	0.6 A	1.2 A	1.2 A
Loadability of modular contactors see page 54						
The max. number of switching for max. load:	600 switch/hr.	600switch/hr.	600 switch/hr.	600 switch/hr.	600 switch/hr.	600 switch/hr.
<b>Electrical life in 230/400 V</b>						
AC-1- resistive load :	200.000	200.000	200.000	200.000	100.000	100.000
AC-3-power load:	300.000	300.000	300.000	500.000	500.000	150.000
AC-5a - high-intensity discharge lamp:	100.000 by 30 µF	100.000 by 30 µF	300.000 by 36 µF	100.000 by 36 µF	100.000 by 220 µF	100.000 by 330 µF
AC-5b - incandescent lamps :	100.000 by 2 kW	100.000 by 2 kW	100.000 by 2 kW	100.000 by 2 kW	100.000 by 4 kW	100.000 by 5 kW
AC-7a - resistive household devices:	200.000	200.000	200.000	200.000	100.000	100.000
AC-7b - inductive household devices:	300.000	300.000	300.000	300.000	150.000	150.000
Minimal load:	≥ 17 V, ≥ 50 mA	≥ 17 V, ≥ 50 mA	≥ 17 V, ≥ 50 mA	≥ 17 V, ≥ 50 mA	≥ 17 V, ≥ 50 mA	≥ 24 V, ≥ 100 mA
Short circuit protection with the fuse char. aM:	20 A	20 A	20 A	25 A	63 A	80 A
Coordination Type according EN 60 947-4-1:	2	2	2	2	2	2
Dielectrical strength:	4 kV	4 kV	4 kV	4 kV	4 kV	4 kV
<b>Contacts - max. cable size</b>						
Solid conductor:	AWG 7 (10 mm <sup>2</sup> )	AWG 7 (10 mm <sup>2</sup> )	AWG 10 (2.5 mm <sup>2</sup> )	AWG 7 (10 mm <sup>2</sup> )	AWG 3 (25 mm <sup>2</sup> )	AWG 3 (25 mm <sup>2</sup> )
Stranded conductor:	6 mm <sup>2</sup>	6 mm <sup>2</sup>	2.5 mm <sup>2</sup>	6 mm <sup>2</sup>	16 mm <sup>2</sup>	16 mm <sup>2</sup>
Maximal torque:	1.2 Nm	1.2 Nm	1.2 Nm	1.2 Nm	3.5 Nm	3.5 Nm
<b>Coil - max. cable size</b>						
Solid conductor:	AWG 10 (2.5 mm <sup>2</sup> )	AWG 10 (2.5 mm <sup>2</sup> )	AWG 10 (2.5 mm <sup>2</sup> )	AWG 10 (2.5 mm <sup>2</sup> )	AWG 10 (2.5 mm <sup>2</sup> )	AWG 10 (2.5 mm <sup>2</sup> )
Stranded conductor:	2.5 mm <sup>2</sup>	2.5 mm <sup>2</sup>	2.5 mm <sup>2</sup>	2.5 mm <sup>2</sup>	2.5 mm <sup>2</sup>	2.5 mm <sup>2</sup>
Max. torque:	0.6 Nm	0.6 Nm	0.6 Nm	0.6 Nm	0.6 Nm	0.6 Nm
<b>Operating</b>						
Coil control voltage:	AC/DC 24 V, 230 V	AC/DC 24 V, 48 V, 110 V, 230 V	AC 12 V, 24 V, 48 V, 110 V, 230 V	AC/DC 24 V, 48 V, 110 V, 230 V	AC/DC 24 V, 110 V, 230 V	AC/DC 24 V, 48 V, 110 V, 230 V
Coil permanent supply +/- 10 %:	2.1 VA/2.1 W	2.1 VA/2.1 W	5 VA/1.5 W	2.6 VA/2.6 W *	5 VA/5 W	5 VA/5 W
Coil gear supply +/- 10 %:	2.1 VA/2.1 W	2.1 VA/2.1 W	30 VA/25 W	2.6 VA/2.6 W *	5 VA/5 W	5 VA/5 W
Mounting side-by-side:	max. 2 contactors**	max. 2 contactors**	max. 2 contactors**	max. 2 contactors**	max. 2 contactors**	max. 2 contactors**
Operational temperature:	-5 to +55 °C (23 to 131 °F)					
Storing temperature:	-30 to +80 °C (-22 to 176 °F)					
Weight:	120 g (4.2 oz.)	130 g (4.6 oz.)	170 g (6 oz.)	213 g (7.5 oz.)	400 g (14 oz.)	400 g (14 oz.)
Dimensions:	17.5 x 85 x 60 mm (0.7" x 3.35" x 2.4")	17.5 x 85 x 60 mm (0.7" x 3.35" x 2.4")	35 x 62.5 x 57 mm (1.4" x 2.7" x 2.24")	35 x 85 x 60 mm (1.4" x 3.35" x 2.4")	53.3 x 84 x 60 mm (2.1" x 3.31" x 2.4")	53.3 x 84 x 60 mm (2.1" x 3.31" x 2.4")
Standards:	IEC 60947-4-1, IEC 60947-5-1, IEC 61095, EN 60947-4-1, EN 60947-5-1, EN 61095, EN 60947-1					

\* 3.8 VA/3.8 W for -04 version of contacts

\*\* Note: In case several contactors are mounted close to each other, you need to use a installation spacer between every other contactor.



EAN code  
see page 55

Technical parameters	VSM220	VSM425
Rated insulation voltage (Ui):	230 V	440 V
Rated thermo-current $I_{th}$ (in AC):	20 A	25 A
<b>Switched operation</b>		
AC-1 for 400 V:	x	16 kW, 3 phase
AC-1 for 230 V:	4 kW, 1 phase	9 kW, 3 phase
AC-3 for 400 V:	x	4 kW, 3 phase
AC-3 for 230 V:	1.3 kW only NO, 1 phase	2.2 kW, 3 phase
AC-7a for 400 V:	x	16 kW, 3 phase
AC-7a for 230 V:	4 kW, 1 phase	9 kW, 3 phase
AC-7b for 400 V:	x	4 kW, 3 phase
AC-7b for 230 V:	1.3 kW only NO, 1 phase	2.2 kW, 3 phase
AC-15 for 400 V:	4 A	4 A
AC-15 for 230 V:	6 A	6 A
DC1 $U_e = 24$ V:	20 A	25 A
DC1 $U_e = 110$ V:	6 A	6 A
DC1 $U_e = 220$ V:	0.6 A	0.6 A
Loadability of modular contactors see page 54		
The max. number of switching for max. load:	600 switch/hr.	600 switch/hr.
<b>Electrical life in 230/400 V</b>		
AC-1- resistive load :	200.000	200.000
AC-3-power load:	300.000	500.000
AC-5a - high-intensity discharge lamp:	100.000 by 30 $\mu$ F	100.000 by 36 $\mu$ F
AC-5b - incandescent lamps :	100.000 by 1.5 kW	100.000 by 1.5 kW
AC-7a - resistive household devices:	200.000	200.000
AC-7b - inductive household devices:	300.000	500.000
Minimal load:	$\geq 17$ V, $\geq 50$ mA	$\geq 17$ V, $\geq 50$ mA
Short circuit protection with the fuse char. aM:	20 A	25 A
Coordination Type according EN 60 947-4-1:	2	2
Electrical strenght:	4 kV	4 kV
<b>Contacts - max. cable size</b>		
Solid conductor:	AWG 7 (10 mm <sup>2</sup> )	AWG 7 (10 mm <sup>2</sup> )
Stranded conductor:	6 mm <sup>2</sup>	6 mm <sup>2</sup>
Maximal torque:	1.2 Nm	1.2 Nm
<b>Coil - max. cable size</b>		
Solid conductor:	AWG 10 (2.5 mm <sup>2</sup> )	AWG 10 (2.5 mm <sup>2</sup> )
Stranded conductor:	2.5 mm <sup>2</sup>	2.5 mm <sup>2</sup>
Max. torque:	0.6 Nm	0.6 Nm
<b>Operating</b>		
Coil control voltage:	AC 12 V, 24 V, 110 V, 230 V	AC 12 V, 24 V, 42 V, 230 V
Coil permanent supply +/- 10 %:	2.8 VA/1.2 W	5.5 VA/1.6 W
Coil gear supply +/- 10 %:	12 VA /10 W	33 VA/25 W
Mounting side-by-side:	max. 2 contactors*	max. 2 contactors*
Operational temperature:	-5 to +55 °C (23 to 131 °F)	
Storing temperature:	-30 to +80 °C (-22 to 176 °F)	
Weight:	140 g (4.9 oz.)	260 g (9.17 oz.)
Dimensions:	17.5 x 85 x 60 mm (0.7" x 3.35" x 2.4")	35 x 85 x 60 mm (1.4" x 3.35" x 2.4")
Standards:	IEC 60947-4-1, IEC 60947-5-1, IEC 61095, EN 60947-4-1, EN 61095, EN 60947-1	

- Special version of installation contactors with not only basic functions but also with manual control.
- For switching accumulative appliances for heating and service water warming.
- Description of individual positions of manual control.
  - AUTO: common function as with installation contactors without manual control.
  - 1: shifting from AUTO to 1: operational contacts are closed and back contacts are open until there is another impulse to a contactor coil.
  - 0: contacts are open (operational contact) or closed (stand-by contact) regardless voltage.
- Optical indicator: ON-OFF.
- It is produced in configuration of making and breaking contacts:
  - VSM220: 20, 11, 02
  - VSM425: 40, 31, 22, 04
- It is possible to connect auxiliary contacts VSK to contactors VSM220, VSM425.

#### Connection VSM220

VSM220 - only AC supply voltage

##### VSM220-20

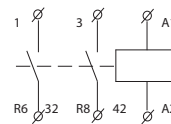

##### VSM220-11

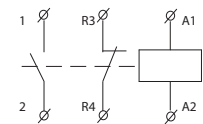

##### VSM220-02

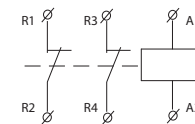

#### Connection VSM425

VSM425 - only AC supply voltage

##### VSM425-40

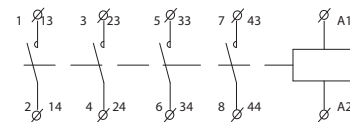

##### VSM425-31

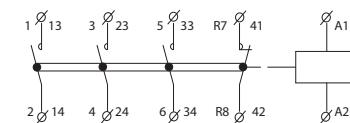

##### VSM425-22

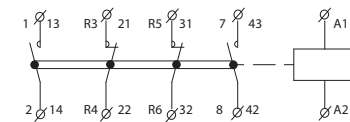

##### VSM425-04

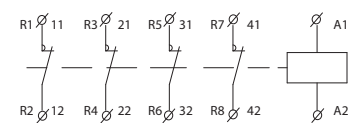

#### Auxiliary contacts VSK-11 and VSK-20

Datas of auxiliary contacts for VSK-11 and VSK-20 see page 57.

\* Note: In case several contactors are mounted close to each other, you need to use a installation spacer between every other contactor.



VS120

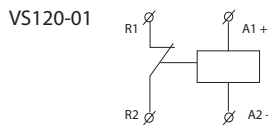
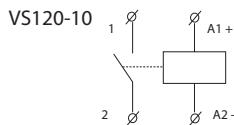

VS220

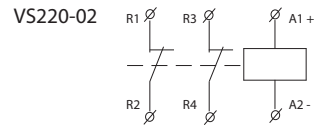
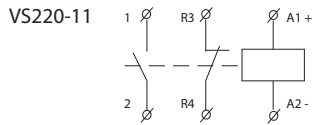
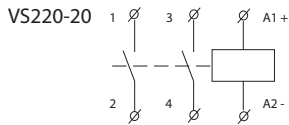

VS420

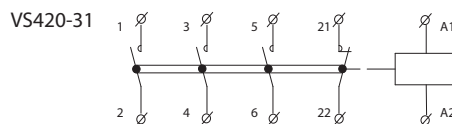
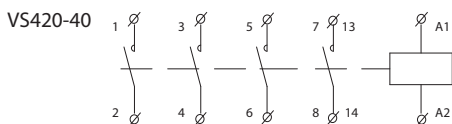

VS425

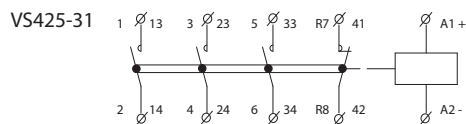
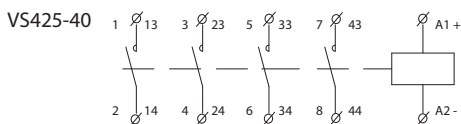

VS425-22

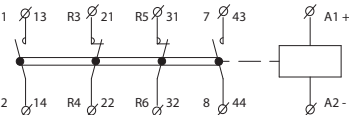

VS425-13

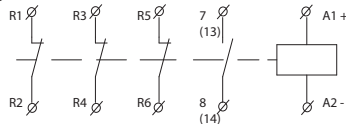

VS425-04

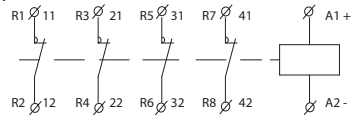

VS440

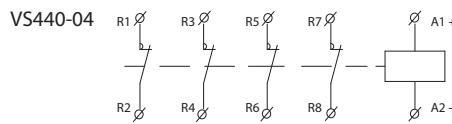
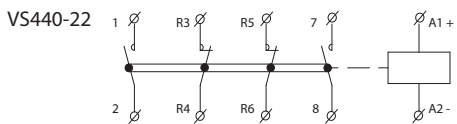
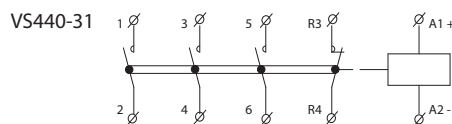
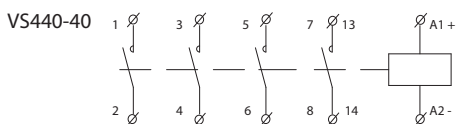

VS463

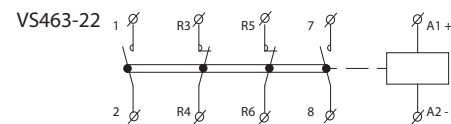
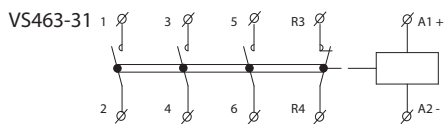
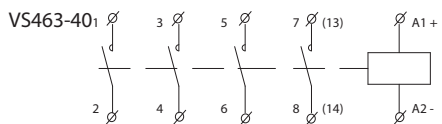

Auxiliary contacts for VS425, VS440, VS463 and VSM220, VSM425

Datas of auxiliary contacts for VSK-11 and VSK-20

Ambient temperature:	-5 °C to +55 °C (23 °F to 131 °F)
Rated insulation voltage (Ui):	500 V
Dielectrical strength:	4 kV
Rated current 230 V (AC 15):	6 A
Rated current 400 V (AC 15):	4 A
Max. switching frequency:	6 A
The max. number of switching for max. load:	600 sep./hod.
Minimal load:	≥ 12 V, ≥ 10 mA
Short circuit protection with the fuse char. aM:	6 A
Solid/Stranded conductor (max):	2.5 mm <sup>2</sup> /2.5 mm <sup>2</sup> (AWG 10)
Maximal torque:	0.8 Nm
Weight:	10 g (0.35 oz.)
Dimensions:	10 x 85 x 60 mm (0.4" x 3.35" x 2.4")

Connection of auxiliary contact VSK-11 and VSK-20

EAN code see page 59

VSK-11



VSK-20

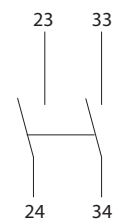

## Loadability of installation contactors

TYPE OF LIGHT	OPERATION (W)	I (A)	Number of lights on one contactor's contact							
			VS120	VS220	VS420	VS425	VS440	VS463	VSM220	VSM425
Incandescent lamps	60	0.26	33	33	33	33	65	85	33	33
	100	0.43	20	20	20	20	40	50	20	20
	200	0.87	10	10	10	10	20	25	10	10
	500	2.17	3	3	3	3	8	10	3	3
	1000	4.35	1	1	1	1	4	5	1	1
Flourescent lamps	18	0.37	22	22	22	24	90	140	22	24
	24	0.35	22	22	22	24	90	140	22	24
	36	0.43	17	17	17	20	65	95	17	20
	58	0.67	14	14	14	17	45	70	14	17
Flourescent lamps lead-lag circuit	18	0.11	2 x 30	2 x 30	2 x 30	2 x 40	2 x 100	2 x 150	2 x 30	2 x 40
	24	0.14	2 x 24	2 x 24	2 x 24	2 x 31	2 x 78	2 x 118	2 x 24	2 x 31
	36	0.22	2 x 17	2 x 17	2 x 17	2 x 24	2 x 65	2 x 95	2 x 17	2 x 24
	58	0.35	2 x 10	2 x 10	2 x 10	2 x 14	2 x 40	2 x 60	2 x 10	2 x 14
Flourescent lamps parallel correction	18	0.12	7	7	7	8	48	73	7	8
	24	0.15	7	7	7	8	48	73	7	8
	36	0.2	7	7	7	8	48	73	7	8
	58	0.32	4	4	4	5	31	47	4	5
Flourescent lamps with electronic ballast units (EVG)	1 x 18	0.09	25	25	25	35	100	140	25	35
	1 x 36	0.16	15	15	15	20	52	75	15	20
	1 x 58	0.25	14	14	14	19	50	72	14	19
	2 x 18	0.17	12	12	12	17	50	70	12	17
	2 x 36	0.32	7	7	7	10	26	38	7	10
	2 x 58	0.49	7	7	7	9	25	36	7	9
High-pressure mercury-vapour lamps uncorrected	50	0.61	14	14	14	18	38	55	14	18
	80	0.8	10	10	10	13	29	42	10	13
	125	1.15	7	7	7	9	20	29	7	9
	250	2.15	4	4	4	5	10	15	4	5
	400	3.25	2	2	2	3	7	10	2	3
	700	5.4	1	1	1	2	4	6	1	2
	1000	7.5	1	1	1	1	3	4	1	1
High-pressure mercury-vapour lamps parallel correction	50	0.28	4	4	4	5	31	47	4	5
	80	0.41	4	4	4	5	27	41	4	5
	125	0.65	3	3	3	4	22	33	3	4
	250	1.22	1	1	1	2	12	18	1	2
	400	1.95	1	1	1	1	9	13	1	1
	700	3.45	-	-	-	-	5	7	-	-
	1000	4.8	-	-	-	-	4	5	-	-
Halogen metal vapour lamps uncorrected	35	0.53	18	18	18	22	43	60	18	22
	70	1	10	10	10	12	23	32	10	12
	150	1.8	5	5	5	7	12	18	5	7
	250	3	3	3	3	4	7	10	3	4
	400	3.5	3	3	3	3	6	9	3	3
	1000	9.5	1	1	1	1	2	3	1	1
	2000	16.5	-	-	-	-	1	1	-	-
Halogen metal-vapour lamps parallel correction	35	0.25	5	5	5	6	36	50	5	6
	70	0.45	2	2	2	3	18	25	2	3
	150	0.75	1	1	1	1	11	15	1	1
	250	1.5	-	-	-	1	6	9	-	1
	400	2.5	-	-	-	1	6	8	-	1
	1000	5.8	-	-	-	-	2	3	-	-
	2000	11.5	-	-	-	-	1	2	-	-
High-pressure sodium-vapour lamps uncorrected	150	1.8	5	5	5	6	17	22	5	6
	250	3	3	3	4	10	13	3	4	
	400	4.7	2	2	2	2	6	8	2	2
	1000	10.3	-	-	-	1	3	3	-	1
High-pressure sodium-vapour lamps parallel correction	150	0.83	1	1	1	1	11	16	1	1
	250	1.5	-	-	-	1	6	10	-	1
	400	2.4	-	-	-	-	4	6	-	-
	1000	6.3	-	-	-	-	2	3	-	-
Low-pressure sodium-vapour lamps uncorrected	18	0.35	22	22	22	27	71	90	22	27
	35	1.5	7	7	7	9	23	30	7	9
	55	1.5	7	7	7	9	23	30	7	9
	90	2.4	4	4	4	5	14	19	4	5
	135	3.5	3	3	3	4	10	13	3	4
	180	3.3	3	3	3	4	10	13	3	4
Low-pressure sodium-vapour lamps parallel correction	18	0.35	6	6	6	7	44	66	6	7
	35	0.31	1	1	1	1	11	16	1	1
	55	0.42	1	1	1	1	11	16	1	1
	90	0.63	1	1	1	1	8	12	1	1
	135	0.94	-	-	-	-	4	7	-	-
	180	1.16	-	-	-	-	5	8	-	-

**EAN codes for VS**

VS120

VS120-01 24V AC/DC: 8595188129848  
 VS120-01 230V AC/DC: 8595188123105

VS120-10 24V AC/DC: 8595188129367  
 VS120-10 230V AC/DC: 8595188123112

VS220

VS220-02 24V AC/DC: 8595188129381  
 VS220-02 110V AC/DC: 8595188138628  
 VS220-02 230V AC/DC: 8595188121422

VS220-11 24V AC/DC: 8595188129374  
 VS220-11 48V AC/DC: 8595188129398  
 VS220-11 110V AC/DC: 8595188130790  
 VS220-11 230V AC/DC: 8595188121408

VS220-20 24V AC/DC: 8595188125253  
 VS220-20 48V AC/DC: 8595188129411  
 VS220-20 110V AC/DC: 8595188129428  
 VS220-20 230V AC/DC: 8595188121392

VS420

VS420-31 24V AC: 8595188129442  
 VS420-31 110V AC: 8595188129466  
 VS420-31 230V AC: 8595188121446

VS420-40 12V AC: 8595188129459  
 VS420-40 24V AC: 8595188129435  
 VS420-40 48V AC: 8595188138581  
 VS420-40 230V AC: 8595188121439

VS425

VS425-04 24V AC/DC: 8595188129527  
 VS425-04 48V AC/DC: 8595188129558  
 VS425-04 110V AC/DC: 8595188160032  
 VS425-04 230V AC/DC: 8595188121682

VS425-13 230V AC/DC: 8595188129473

VS425-22 24V AC/DC: 8595188129541  
 VS425-22 230V AC/DC: 8595188121675

VS425-31 24V AC/DC: 8595188129497  
 VS425-31 48V AC/DC: 8595188137898  
 VS425-31 110V AC/DC: 8595188129534  
 VS425-31 230V AC/DC: 8595188121668

VS425-40 24V AC/DC: 8595188129480  
 VS425-40 48V AC/DC: 8595188136174  
 VS425-40 230V AC/DC: 8595188121651

VS440

VS440-04 24V AC/DC: 8595188129299  
 VS440-04 110V AC/DC: 8595188129305  
 VS440-04 230V AC/DC: 8595188121484

VS440-22 24V AC/DC: 8595188129787  
 VS440-22 230V AC/DC: 8595188121477

VS440-31 24V AC/DC: 8595188129572  
 VS440-31 230V AC/DC: 8595188121460

VS440-40 24V AC/DC: 8595188129565  
 VS440-40 110V AC/DC: 8595188138567  
 VS440-40 230V AC/DC: 8595188121453

VS463

VS463-22 24V AC/DC: 8595188129794  
 VS463-22 230V AC/DC: 8595188121514

VS463-31 24V AC/DC: 8595188129596  
 VS463-31 110V AC/DC: 8595188137904  
 VS463-31 230V AC/DC: 8595188121507

VS463-40 24V AC/DC: 8595188129589  
 VS463-40-48V AC/DC: 8595188160612  
 VS463-40 110V AC/DC: 8595188140652  
 VS463-40 230V AC/DC: 8595188121491

**EAN codes for VSM**

VSM220

VSM220-02 24V AC: 8595188129817  
 VSM220-02 230V AC: 8595188128100

VSM220-11 24V AC: 8595188129800  
 VSM220-11 230V AC: 8595188128094

VSM220-20 12V AC: 8595188138369  
 VSM220-20 24V AC: 8595188128117  
 VSM220-20 110V AC: 8595188160223  
 VSM220-20 230V AC: 8595188128087

VSM425

VSM425-04 24V AC: 8595188129831  
 VSM425-04 230V AC: 8595188128155

VSM425-22 24V AC: 8595188129336  
 VSM425-22 230V AC: 8595188128148

VSM425-31 24V AC: 8595188129824  
 VSM425-31 230V AC: 8595188128131

VSM425-40 12V AC: 8595188160049  
 VSM425-40 24V AC: 8595188128162  
 VSM425-40 230V AC: 8595188128124

**EAN codes for VSK and covers**

VSK-11: 8595188121613  
 VSK-20: 8595188121606

VS220: 8595188121576  
 VS425: 8595188121583  
 VS440: 8595188121590

## MEMORY RELAYS

**MR-41**

Voltage range: AC 230 V  
or AC/DC 12 -240 V  
Output contact: 1x  
changeover/SPDT 16 A.  
page 61

**MR-42**

Voltage range: AC 230 V  
or AC/DC 12 -240 V  
Output contact: 2x  
changeover/DPDT 16 A.  
page 61

## BISTABLE (IMPULSE) RELAYS

**BR-216-10**

Number of contacts: 1x 16  
A. Switch configuration  
and NC contacts: 10.  
page 62

**BR-216-11**

Number of contacts: 2x 16  
A. Switch configuration  
and NC contacts: 11.  
page 62

**BR-216-20**

Number of contacts: 2x 16  
A. Switch configuration  
and NC contacts: 20.  
page 62

**BR-220-20**

Number of contacts: 2x 20  
A. Switch configuration  
and NC contacts: 20.  
page 62

**BR-232-20**

Number of contacts: 2x 32 A.  
Switch configuration  
and NC contacts: 20.  
page 62

## TWILIGHT AND LIGHT SWITCHES

**SOU-1**

Twilight switch. Voltage  
range: AC 230 V or AC/  
DC 12-240 V Output  
contact: 1x changeover/  
SPDT 16 A.  
page 64

**SOU-2**

Twilight switch with digital  
time clock. Voltage range:  
AC 230 V (50 - 60 Hz) Output  
contact: 1x changeover/  
SPDT 8 A.  
page 65

**SOU-3**

Twilight and light switch.  
Voltage range: AC 230 V  
(50 - 60 Hz) Output con-  
tact: 1x NO/SPST 16 A.  
page 66

Accessories  
for SOU-1, SOU-2**SKS-100**

It is suitable for mounting  
on the wall or in panel.  
Protection degree: IP65.  
EAN code:  
8595188180733

**Plug-in module**

Suitable backup battery  
type CR2032 (3V) EAN  
code: 209930603123



EAN code  
 MR-41 /230 V: 8595188115889  
 MR-41 /UNI: 8595188115896  
 MR-42 /230 V: 8595188115902  
 MR-42 /UNI: 8595188115919

Technical parameters	MR-41	MR-42
Number of functions:	1	2
Supply terminals:	A1 - A2	
Voltage range:	AC/DC 12 - 240 V (AC 50/60 Hz)	
Burden (max.):	AC 0.17 - 3 VA/DC 0.1 - 1.2 W	AC 0.17 - 12 VA/DC 0.11 - 1.9 W
Voltage range:	AC 230 V (50/60 Hz)	
Consumption (apparent/loss):	AC max. 12 VA/1.2 W	AC max. 12 VA/1.9 W
Max. dissipated power (Un + terminals):	3 W	4.5 W
Supply voltage tolerance:	-15 %; +10 %	
Supply indication:	green LED	
<b>Output</b>		
Number of contacts:	1x changeover/SPDT (AgSnO <sub>2</sub> )	2x changeover/DPDT (AgSnO <sub>2</sub> )
Current rating:	16 A/AC1	
Breaking capacity:	4000 VA/AC1, 384 W/DC	
Inrush current:	30 A/< 3 s	
Switching voltage:	250V AC/24V DC	
Output indication:	red LED	
Mechanical life:	30.000.000 operations	
Electrical life (AC1):	70.000 operations	
<b>Controlling</b>		
Consumption of input:	AC 0.025 - 0.2 VA/DC 0.1 - 0.7 W (UNI), AC 0.53 VA (AC 230 V)	
Load between A2-ON/OFF:	Yes	
Control terminals:	A1 - ON/OFF	
Glow tubes connctions:	230 V - Yes/UNI - No	
Max. amount of glow lamps connected to controlling input:	UNI - glow lamps cannot be connected, 230 V - max. amount 5 pcs (measured with glow lamp 0.68 mA/230 V AC)	
Impulse length:	min. 25 ms/max. unlimited	
<b>Other data</b>		
Operating temperature:	-20 °C to +55 °C (-4 °F to 131 °F)	
Storage temperature:	-30 °C to +70 °C (-22 °F to 158 °F)	
Dielectrical strength:	4 kV (supply - output)	
Operating position:	any	
Mounting:	DIN rail EN 60715	
Protection degree:	IP40 from front panel/IP20 terminals	
Overvoltage category:	III.	
Pollution degree:	2	
Max. cable size (mm <sup>2</sup> ):	solid wire max. 1x 2.5 or 2x 1.5/ with sleeve max. 1x 2.5 (AWG 12)	
Dimensions:	90 x 17.6 x 64 mm (3.5" x 0.7" x 2.5")	
Weight:	(UNI)-64 g (2.3 oz.), (230)-61 g (2.2 oz.)	(UNI)-88 g (3.1 oz.), (230)-85 g (3 oz.)
Standards:	EN 60669-1, EN 60669-2-1	

- Latching relays, controlled by buttons from several locations can replace three way switches or cross bar switches thanks to control by buttons (unlimited number, connected in parallel by 2 wires), installation gets more transparent and faster for mounting.
- Relays MR-41/UNI, MR-42/UNI memorize its last state even after supply failure. During the failure relay will turn off and after re-energizing will automatically turns on.
- **MR-42**
  - options - 2x parallel contacts or the other relay is latching
  - function selected via external jumper between B1 - B2.

Connection

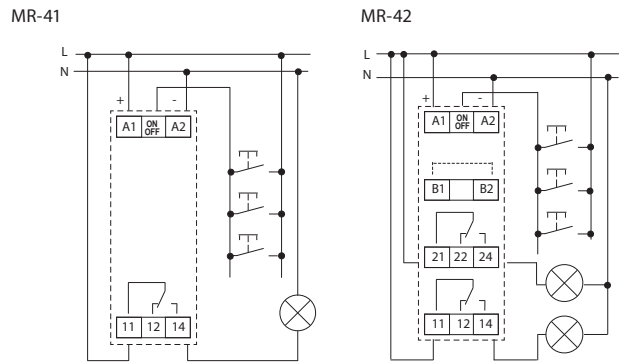

Function

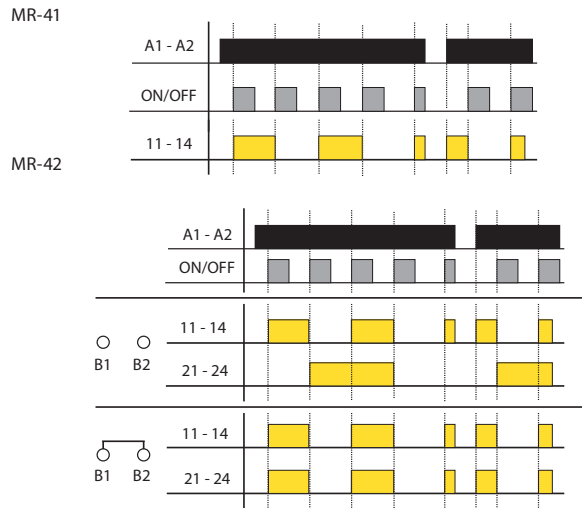

Symbol

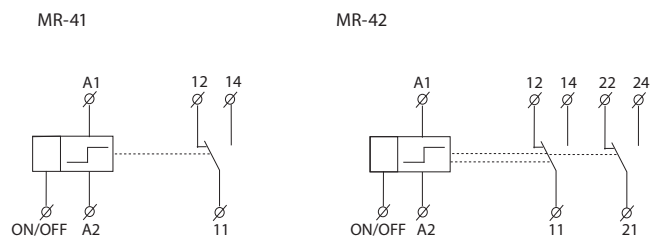



EAN code

BR-216-10/230V: 8595188168854  
 BR-216-11/230V: 8595188168878  
 BR-216-20/230V: 8595188168861  
 BR-220-20/230V: 8595188168885  
 BR-232-20/230V: 8595188168892

- Bistable relays are used to switch electrical circuits by impulse command, especially for lighting control in ordinary houses, warehouses, production halls and other buildings.
- Faster and easier installation thanks to an unlimited number of buttons, connected in parallel by two wires, which is a practical replacement for AC and cross switches.
- Last but not least, they offer savings in the number of wires used and, in the case of the control circuit, the possibility of using wires with a smaller cross-section, where the power input is minimal compared to the power circuit.
- The state of the Bistable relay changes with a short control pulse. As a result of which the relay in the steady state has zero consumption and is noiseless.
- All relays can be controlled manually using a switch on the relay panel (I-O), which also serves as to signal the status of the contacts.
- For types BR-220 and BR-232, it is possible to disconnect the electrical switch control and as a result the state of the relay can then only be changed manually (service, maintenance).

Technical parameters	BR-216-10/11/20	BR-220-20	BR-232-20
<b>Main circuit (contact)</b>			
Rated insulation voltage (U <sub>i</sub> ):		440 V	
Thermal current (I <sub>th</sub> ):	16 A	20 A	32 A
Number of poles:	1, 2, 2	2	2
Contact configuration:	10, 11, 20	20	20
Operational Power (P <sub>o</sub> )			
AC-1, AC-7a for 230 V, 1 phase:	3.5 kW	4.4 kW	7 kW
AC-2 for 230 V, 1 phase:	1.2 kW	1.5 kW	2.4 kW
AC-3, AC-7b for 230V, 1 phase:	0.37 kW	0.55 kW	1.1 kW
DC-1 (L/R ≤ 1 ms)			
U <sub>e</sub> = 24V (1 contact/2 contacts in series):	16A/16A	20A/20A	32A/32A
U <sub>e</sub> = 48V (1 contact/2 contacts in series):	12A/5A	15A/18A	25A/28A
U <sub>e</sub> = 60V (1 contact/2 contacts in series):	8A/14A	10A/15A	20A/22A
U <sub>e</sub> = 110V (1 contact/2 contacts in series):	4A/7A	5A/8A	7A/12A
U <sub>e</sub> = 220V (1 contact/2 contacts in series):	0.4A/3A	0.5A/4A	0.7A/6A
Load capacity of light sources AC-5a, AC-5b			
Max. operating frequency (op./hr)			
without load:	900	900	450
AC-1, AC-7a:	600	600	450
AC-2:	120	120	120
AC-3, AC-7b:	600	600	450
AC-5a, AC-5b:	600	600	450
DC-1:		300	
Electrical endurance: DC-1, DC-3, DC-5, AC-1, AC-7a, AC-2, AC-3, AC-7b, AC-5a / AC-5b (I <sub>e</sub> = 10 A):		100 000 op. c.	
Mechanical lifetime:		1 000 000 op. C	
Power dissipation per pole:	1 W	1.5 W	3 W
Contact reliability:		>10 V, >100 mA	
Max. back-up fuse against short circuit gL/gG (I <sub>v</sub> ) - coordination type 1:	16 A	20 A	32 A
Rated impulse withstand voltage (U <sub>imp</sub> ):		4 kV	
Overload current withstand capability: 10s:	48 A	56 A	80 A
Terminal capacity (solid and stranded):		1 až 10 mm <sup>2</sup>	
Maximum tightening torque:		1.2 Nm	
Screw head:		PZ2	
<b>Control circuit (coil)</b>			
Rated control voltage:		AC 230V	AC 120 V
Rated frequency:		50 Hz	60 Hz
Impulse duration:		min. 50 ms/max. 1 h	
Duration between two impulses (of control voltage):		min. 150 ms	
Maximum load of illuminated buttons (glow lamps, LEDs,...):		2,5mA	
Terminal capacity (solid and stranded):		1 to 4 mm <sup>2</sup>	
Maximum tightening torque:		0.6 Nm	
Screw head:		PZ1	
<b>General</b>			
Mounting:		DIN Rail, TH35 (IEC/EN 60715)	
Number of contactors or switches side-by-side:		no limitation under 55 °C (55 to 70 °C max. 3)/ 131 °F (131 °F - 158 °F)	
Degree of protection:		IP20	
Operational temperature:		-25 to +55 °C (> 55 to +70 at max. pulse length - 1min) (13 °F to 131 °F (> 131 to 158 at max. pulse length - 1min))	
Storing temperature:		-30 to +80 °C (-22 °F to 176 °F)	
Disconnection of remote control(coil) by switch:	no	yes	yes
Standards:		IEC/EN 60669-2-2	

## Connection

## BR-216-10

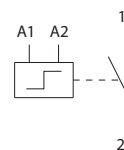

## BR-216-11

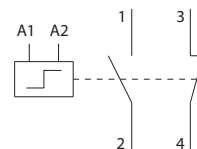

## BR-216-20

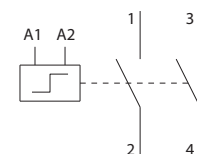

## BR-220-20

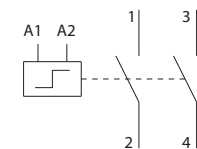

## BR-232-20

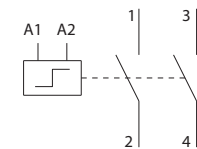

## Connection BR-216-10

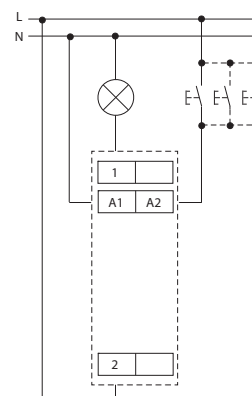

Lamps Type	Power	Current	Capacitor	Maximum number of lamps per pole		
	P (W)	I (A)	C (µF)	BR-216-10/11/20	BR-220-20	BR-232-20
LED lamps Power supplies for LEDs	-	-	-	max. 2 A per pole	max. 6 A per pole	max. 12 A per pole
Incandescent lamps and halogen lamps	15	0,07	-	133	133	233
	25	0,11	-	80	80	140
	40	0,17	-	50	50	88
	60	0,26	-	33	33	58
	75	0,33	-	27	27	47
	100	0,44	-	20	20	35
	150	0,65	-	13	13	23
	200	0,87	-	10	10	18
	300	1,3	-	7	7	12
Fluorescent lamps with external electromagnetic ballasts - uncorrected	18	0,37	-	43	43	43
	36	0,43	-	37	37	37
	58	0,67	-	24	24	24
	18	0,19	4,5	18	22	33
	36	0,29	4,5	18	22	33
	58	0,46	7	11	14	21
	2x18	0,26	2,7	62	62	62
	2x36	0,48	4,5	33	33	33
	2x58	0,78	7	21	21	21
Fluorescent lamps with external electronic ballasts	18	0,09	-	33	67	133
	2x18	0,17	-	18	35	71
	36	0,16	-	19	38	75
	2x36	0,31	-	10	19	39
	58	0,25	-	12	24	48
	2x58	0,48	-	6	13	25
	80	0,4	-	8	15	30
	2x80	0,76	-	4	8	16
	High pressure mercury vapour lamps with external electromagnetic ballasts - uncorrected	50	0,6	-	17	27
80		0,8	-	13	20	20
125		1,2	-	8	13	13
250		2,2	-	5	7	7
400		3,3	-	3	5	5
700		5,4	-	2	3	3
1000		7,5	-	1	2	2
High pressure mercury vapour lamps with external electromagnetic ballasts - parallel corrected	50	0,3	7	11	14	21
	80	0,4	8	10	13	19
	125	0,6	10	8	10	15
	250	1,2	18	4	6	8
	400	1,8	25	3	4	6
	700	3,4	40	2	3	4
	1000	4,8	60	1	2	3
Metal halide lamps with external electromagnetic ballasts - uncorrected	35	0,5	-	16	32	32
	70	1	-	8	16	16
	150	1,8	-	4	9	9
	250	3	-	3	5	5
	400	4,6	-	2	3	3
	1000	9,7	-	1	2	2
	2000	12,2	-	0	1	1
Metal halide lamps with external electromagnetic ballasts - parallel corrected	35	0,23	6	13	17	25
	70	0,42	12	7	8	13
	150	0,77	20	4	5	8
	250	1,26	32	3	3	5
	400	2	45	2	2	3
	1000	5	85	0	1	2
	2000	10,5	125	0	0	1
High pressure sodium vapour lamps with external electromagnetic ballasts - uncorrected	150	1,8	-	7	9	9
	250	3	-	4	5	5
	400	4,4	-	3	4	4
	1000	10,3	-	1	1	1
High pressure sodium vapour lamps with external electromagnetic ballasts - parallel corrected	150	0,77	20	4	5	8
	250	1,26	32	3	3	5
	400	2	45	2	2	3
	1000	5,1	100	0	0	1
High pressure sodium vapour lamps with external electronic ballasts	150	0,72	-	4	8	17
	250	1,3	-	2	5	9
	400	2	-	2	3	6
	1000	5	-	0	1	2
Low pressure sodium vapour lamps with external electromagnetic ballasts - uncorrected	18	0,4	-	25	40	40
	35	0,6	-	15	27	27
	55	0,6	-	15	27	27
	90	0,9	-	10	18	18
	135	0,9	-	10	18	18
	180	0,9	-	10	18	18
Low pressure sodium vapour lamps with external electromagnetic ballasts - parallel corrected	18	0,35	5	16	20	30
	35	0,28	20	4	5	8
	55	0,35	20	4	5	8
	90	0,55	26	3	4	6
	135	0,8	40	2	3	4
	180	1	40	2	3	4



EAN code  
 SOU-1/230V + SKS-100: 8595188121002  
 SOU-1/UNI + SKS-100: 8595188101019  
 Photosensor SKS-100: 8594030337288

SKS-100

**Technical parameters** **SOU-1**

Supply terminals:	A1 - A2
Voltage range:	AC/DC 12 - 240 V (AC 50/60 Hz)
Power input max.:	AC 1.5 VA/0.9 W
Voltage range:	AC 230 V (50/60 Hz)
Power input max.:	3 VA/2 W
Max. dissipated power (Un + terminals):	4 W
Supply voltage tolerance:	-15 %; +10 %
Supply indication:	green LED
Time delay:	0 - 2 min
Time delay setting:	potentiometer
Illumination rang LUX1:	1 - 100 Lx
Illumination rang LUX2:	100 - 50 000 Lx

**Output**

Number of contacts:	1x changeover (AgSnO <sub>2</sub> )
Current rating:	16 A/AC1
Breaking capacity:	4000 VA/AC1, 384 W/DC
Inrush current:	30 A/< 3 s
Switching voltage:	250 V AC/24 V DC
Output indication:	red LED
Mechanical life:	10.000.000 operations
Electrical life (AC1):	70.000 operations

**Control**

Power the control input:	0.3 W
Load between S-A2:	yes
Control. terminals:	A1 - S
Impulse length:	min. 25 ms/max. unlimited
Reset time:	150 ms

**Other information**

Operating temperature:	-20 °C to +55 °C (-4 °F to 131 °F)
Storage temperature:	-30 °C to +70 °C (-22 °F to 158 °F)
Dielectrical strength:	4 kV (supply - output)
Operating position:	any
Mounting:	DIN rail EN 60715
Protection degree:	IP40 from front panel/IP20 terminals
Sensor cable length:	max. 50 m (standard wire)
Overtoltage category:	III.
Pollution degree:	2
Max. cable size (mm <sup>2</sup> ):	solid wire max. 1x 2.5 or 2x 1.5/ with sleeve max. 1x 2.5 (AWG 12)
Dimensions:	90 x 17.6 x 64 mm (3.5 x 0.7 x 2.5 inch)
Weight:	(UNI): 66 g (2.3 oz.)/(230 V): 63 g (2.2 oz.)
Dimensions of sensor SKS -100:	58 x Ø 24 mm (2.3" x Ø 0.9")
Weight of sensor SKS-100	20 g (0.5 oz.)
Standards:	EN 60669-1, EN 60669-2-1

- Is used to control lights on the basis of ambient light intensity.
- Used for switching street illumination and garden lights, illumination of advertisements, shop windows, etc.
- Level of ambient intensity is monitored by an external sensor SKS-100 and output is switched according to set level on the device.
- Control input for additional control, e.g. time switch, preswitch etc.
- Level of illumination adjustable in two ranges:  
1 - 100 lx and 100 - 50000 lx.
- Adjustable time delay to eliminate short term fluctuation in illumination.
- External sensor IP65 suitable for mounting on the wall (cover and holder of a sensor are a part of the package).

**Description**

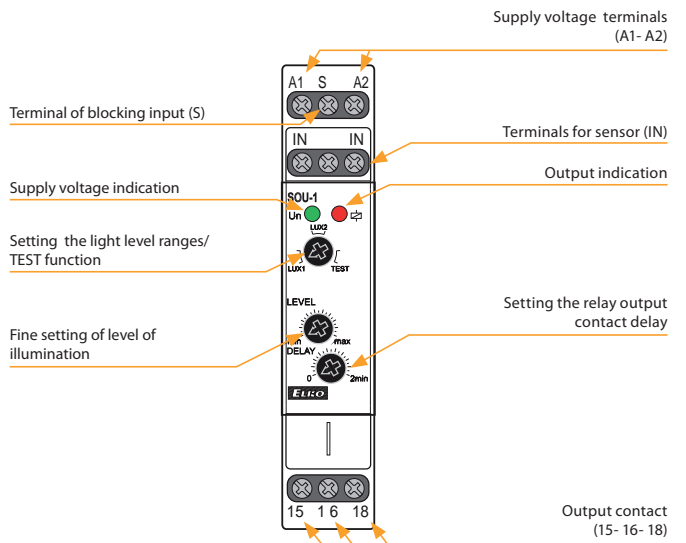

LUX1: Range 1 - 100 Lx.

LUX2: Range 100 - 50 000 Lx.

TEST: By switching to position TEST all function are switched off and switching contacts of output relay are switched on. The function TEST is used for testing of right connection of load and for verification of failure (breaking of the bulb).

**Connection**

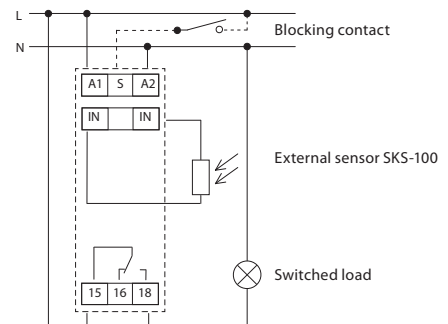

**Function**

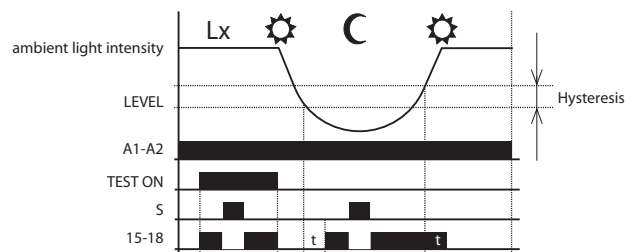





EAN code  
 SOU-2 + SKS-200: 8595188182348  
 SOU-2: 8595188182355  
 Photosensor SKS-200: 8595188182331

SKS-200

Technical parameters		SOU-2
Supply terminals:	A1 - A2	
Voltage range:	AC 230 V (50/60 Hz)	
Burden:	max. 4 VA/1.5 W	
Max. dissipated power (Un + terminals):	3 W	
Voltage range:	-15 %; +10 %	
Back-up supply:	yes	
Type of backup battery:	CR 2032 (3V)	
Summer/winter time:	automatic	
Output		
Number of contacts:	1x changeover/SPDT (AgSnO <sub>2</sub> )	
Current rating:	8 A/AC1	
Breaking capacity:	2000 VA/AC1, 240 W/DC	
Switching voltage:	250V AC/30V DC	
Mechanical life:	30.000.000 operations	
Electrical life (AC1):	100.000 operations	
Time circuit		
Power back-up:	3 years	
Accuracy:	max. ±1 s day (23 °C/73.4 °F)	
Minimum interval:	1 min	
Data stored for:	min. 10 years	
Program circuit		
Illumination range:	10-50000 lx	
Sensor failure indication:	displayed on LCD*	
Program place number:	100	
Program period:	daily, weekly, yearly	
Data readout:	LCD display, illuminated by back up	
Other information		
Operating temperature:	-10 °C to +55 °C (-4 °F to 131 °F)	
Storage temperature:	-30 °C to +70 °C (-22 °F to 158 °F)	
Dielectrical strength:	4 kV (supply - output)	
Operating position:	any	
Mounting:	DIN rail EN 60715	
Protection degree:	IP40 from front panel/IP20 terminals	
Overvoltage category:	III.	
Pollution degree:	2	
Max. cable size (mm <sup>2</sup> ):	solid wire max. 1x 2.5 or 2x 1.5, with sleeve max. 1x 1.5 (AWG 12)	
Dimensions:	90 x 35 x 64 mm (3.5" x 1.4" x 2.5")	
Weight:	139 g (4.9 oz.)	
Dimensions of the sensor SKS - 200:	58 x Ø 24 mm (2.3" x Ø 0.9")	
Weight of sensor SKS - 200:	20 g (0.7 oz.)	
Standards:	EN 61812-1, EN 60669-1, EN 60669-2-1	

\* ERROR - sensor short circuit

- Is used for control of lights on the basis of ambient light intensity and real time (combination of SOU-1 and time switch SHT-3 in one device).
- Time clock can override the light sensor for applications when lights are not required.
- Switching: according to a program (AUTO)/permanently manual/random (CUBE).
- External sensor IP65 issuitable for mounting on the wall/in panel (cover and sensors are part of delivery).
- Sealable transparent cover of front panel.
- Backup of data and time by battery (up to 3 years).
- Easy replacement of backup battery with plug-in module located on front panelof device (no disassembly required).

### Description

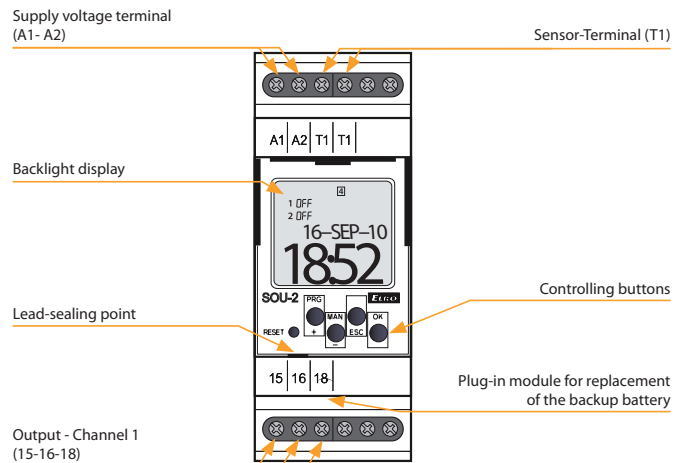

### Description of visual elements on the display

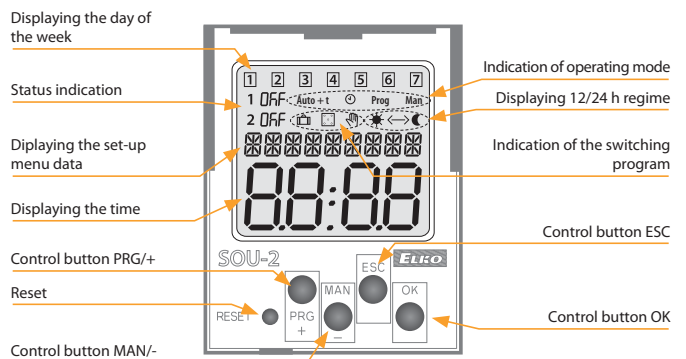

### Connection

### Symbol

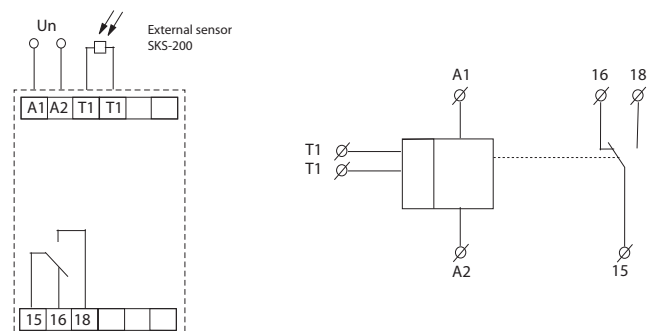



EAN code  
SOU-3 /230 V: 8595188140560

Technical parameters		SOU-3
<b>Supply</b>		
Supply terminals:	L - N	
Voltage range:	AC 230 V (50/60 Hz)	
Input (apparent/loss):	max. 6 VA/0.7 W	
Max. dissipated power (Un + terminals):	2.5 W	
Tolerance of voltage range:	- 15 % to +10 %	
<b>Setting the scale level of lighting</b>		
		by jumper J2
<b>Function ☾ (twilight switch)</b>		
range 1:	1 to 10 lx	
range 2:	10 to 100 lx	
range 3:	100 to 1.000 lx	
<b>Function ☀ (light switch)</b>		
range 1:	100 to 1 000 lx	
range 2:	1 000 to 10 000 lx	
range 3:	10 000 to 100 000 lx	
Setting function	by jumper J3	
Level of light-slight:	0.1 to 1 x range	
Slight setting of light level:	potentiometer	
Time delay t:	0/1 min./2 min.	
Delay setting t:	by jumper J1	
<b>Output</b>		
Output contact:	1x NO- SPST (AgSnO <sub>2</sub> )	
Current rating:	12 A/AC1	
Switching output:	3000 VA/AC1, 384 W/DC	
Peak current:	30 A/< 3 s	
Switched voltage:	250 V AC/24 V DC	
Mechanical life:	30.000.000 operations	
Electrical life:	70.000 operations	
<b>Other information</b>		
Operation temperature:	-30 °C to +60 °C (-22 °F to 140 °F)	
Storing temperature:	-30 °C to +70 °C (-22 °F to 158 °F)	
Dielectrical strength:	4 kV (supply-output)	
Operation position:	sensor-side down or on the sides	
Protection degree:	IP 65	
Overvoltage category:	III.	
Pollution level:	2	
Max. cable size (mm <sup>2</sup> ):	max. 1x 2.5, max. 2x 1.5/ with sleeve max. 1x 2.5 (AWG 12)	
Suggested power-supply cable:	CYKY 3x 2.5 (CYKY 4x 1.5)	
Dimensions:	98 x 62 x 34 mm (3.9" x 2.4" x 1.3")	
Weight:	117 g (4.1 oz.)	
Standards:	EN 60669-1, EN 60669-2-1	

Device is standardly supplied with jumper L-15 (3-wire connection). For the correct function of device is necessary sensor-side down device mounting.

- Is used as control of the device on the basis of ambient light intensity.
- External version in IP65, box for mounting on the wall, front cover removable without screws.
- Built in high resolution light sensor.
- Two devices in one, function is set by jumper:
  - twilight switch - contact closes by decreasing of ambient light intensity, and opens by its increasing.
  - light switch - contact closes by increasing ambient light intensity, and opens by decreasing light intensity. Used for switching of devices by reaching of pre-set ambient light level, usually sun shine (pulling down the shutters or blinds, activation of solar panels).
- 3 adjustable levels of time delay (for elimination of short-term fluctuations of light intensity - for short increases in light intensity).

### Description

Cable gomet M16x1.5  
for cable max. Ø 10 mm/0.4"

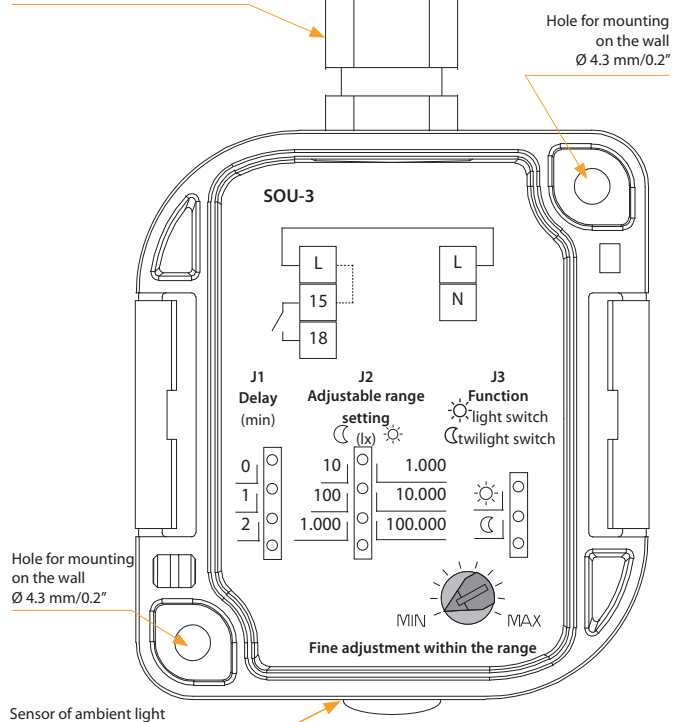

### Connection

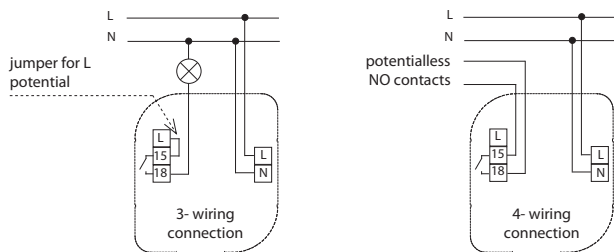

### Function

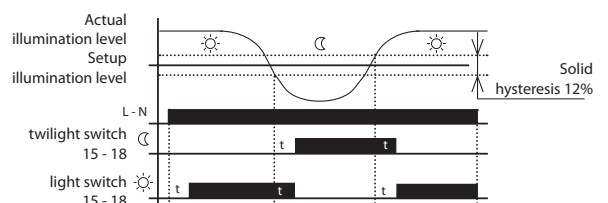

**Stabilized DC switching**

**Voltage 12 V**



**PSB-10-12**

IN: AC 110-250 V  
 OUT: DC 12V stabil  
 LOAD: 0.84 A/10 W  
 - galvanically separated  
 - electronic fuse  
 - thermo protection  
 - MINI, into an installation box (such as KU-68).  
 page 69



**PS1M-15/12V**

Input: AC 100 - 240 V  
 output: DC 12 V stable  
 load: 1.25 A/15 W.  
 page 70



**PS2M-24/12V**

Input: AC 100 - 240 V  
 Output: DC 12 V stable  
 Load: 2 A/24 W.  
 page 70



**PS3M-54/12V**

Input: AC 100-240 V  
 Output: DC 12V stable  
 Load: 4.5 A/54 W.  
 page 70



**PS4M-92/24V**

Input: AC 100 - 240 V  
 Output: DC 12 V stable  
 Load: 7.1 A/85 W  
 page 70

**PS4M-85/12V**

Vstup: AC 100-240 V  
 výstup: DC 12 V stabil  
 zátěž: 7.1 A/85 W.  
 str. 70

**Voltage 24 V**



**PSB-10-24**

IN: AC 110-250 V  
 OUT: DC 24 V stabil  
 LOAD: 0.42A/10W  
 - galvanically separated  
 - electronic fuse  
 - thermo protection  
 MINI, into an installation box (such as KU-68).  
 page 69



**PS1M-15/24V**

Input: AC 100 - 240 V  
 Input: DC 24 V stable  
 load: 0.625 A/15 W.  
 page 70



**PS2M-30/24V**

Input: AC 100 - 240 V  
 Input: DC 24 V stable  
 load: 1.25 A/30 W.  
 page 70



**PS3M-60/24V**

Input: AC 100-240 V  
 Input: DC 24 V stable  
 load: 2.5 A/60 W.  
 page 70



**PS4M-92/24V**

Input: AC 100 - 240 V  
 Input: DC 24 V stable  
 load: 3.83 A/92 W  
 - electronic fuse.  
 page 70



**ZNP-10-24**

IN: AC 230 V  
 OUT: AC/DC 24V nonstabil  
 LOAD: 0.4A / 10 VA  
 - galvanically separated  
 - fuse  
 3 MODULE.  
 page 72

**Regulated switching**



**PS-30-R**

IN: AC 100-250 V  
 OUT: DC 12-24 V regul., stab.  
 LOAD: 2.5-1.25A/30W  
 - galvanically separated  
 - electronic fuse  
 - thermo protection  
 3 MODULE.  
 page 69



**ZSR-30**

IN: AC 230 V  
 OUT: DC 5-24 V reg., stab.  
 OUT: AC 24V, DC24V  
 LOAD: 1.6-0.3A/10 VA  
 - range of incoming voltage  
 - current restrictor  
 - electronic fuse  
 3 MODULE.  
 page 72

**Nonstabilized AC**

**Bell transformers**



**ZTR-8-8**

Output voltage 8 V.  
 Power: 8W.  
 page 73



**ZTR-8-12**

Output voltage 12 V.  
 Power: 8W.  
 page 73



**ZTR-15-12**

Output voltage 4-8-12 V.  
 Power: 4V 5VA;  
 8V 10 VA; 12V 15VA.  
 page 73

Type	Design	Input voltage	Output					Protection against overload			Designation	Page in catalogue	
			AC	DC	Stabilized	Output voltage	Output current	Switching (S)/ Linear (L)	Safety fuse	Electronic fuse			Short-circuit-proof
ZNP-10-24	3M-DIN	AC 230 V	●	●	X	AC 24V DC 24V	0.4 A	X	●	X	●	DC and AC nonstabilized output voltage 24 V – where it is not required or is stabilized later	72
ZSR-30	3M-DIN	AC 230 V	●	●	●	DC 5-24V AC 24 V	1.6 A-0.3 A	X	●	●	●	Regulated output voltage in a wide range DC 5-24 V: possibility to adjust output voltage with load according to request...)	
PSB-10-12	MINI-BOX	AC 110-250 V	X	●	●	DC 12 V	0.84 A	●	X	●	●	Stabilized switching power supply with fixed output voltage 12 V/10 W, box	69
PSB-10-24	MINI-BOX	AC 110-250 V	X	●	●	DC 24V	0.42 A	●	X	●	●	Stabilized switching power supply with fixed output voltage 24 V/10 W, box	
PS-30-R	3M-DIN	AC 100-250 V	X	●	●	DC 12-24V	2.5 A - 1.25 A	●	●	●	●	Stabilized switching power supply with fixed output voltage 12-24 V/30 W, 3 module	
PS1M-15/ 12V	1M-DIN	AC 100 - 240 V	X	●	●	DC 12 V	1.25 A	●	●	●	●	Stabilized switching power supply with fixed output voltage 12 V/10 W, 1 module	70
PS1M-15/ 24V	1M-DIN	AC 100 - 240 V	X	●	●	DC 24V	0.625 A	●	●	●	●	Stabilized switching power supply with fixed output voltage 24 V/10 W, 1 module	
PS2M-24/ 12V	3M-DIN	AC 100 - 240 V	X	●	●	DC 12 V	2 A	●	●	●	●	Stabilized switching power supply with fixed output voltage 12 V/30 W, 3 module	
PS2M-30/ 24V	3M-DIN	AC 100 - 240 V	X	●	●	DC 24V	1.25 A	●	●	●	●	Stabilized switching power supply with fixed output voltage 24 V/30 W, 3 module	
PS3M-54/ 12V	6M-DIN	AC 100 - 240 V	X	●	●	DC 12 V	4.5 A	●	●	●	●	Stabilized switching power supply with fixed output voltage 12 V/100 W, 6 module	
PS3M-60/ 24V	6M-DIN	AC 100 - 240 V	X	●	●	DC 24V	2.5 A	●	●	●	●	Stabilized switching power supply with fixed output voltage 24V/100W, 6 module	
PS4M-85/ 12V	4.5M-DIN	AC 100 - 240 V	X	●	X	DC 12 V	7.1 A	●	●	●	●	efficient switching power supply of DC voltage 12V/54 W, wide range of input voltage (AC 100-240 and DC 124-370 V)	
PS4M-92/ 24V	4.5M-DIN	AC 100 - 240 V	X	●	X	DC 24V	3.83 A	●	●	●	●	Efficient switching power supply of DC voltage 24V/60 W, wide range of input voltage (AC 100-240 and DC 124-370 V)	
ZTR-8-8	2M-DIN	AC 230 V	●	X	X	8 V	1A	X	X	X	●	Bell transformer (short-circuit-proof) for supplying of bells, door openers, home call-boxes	73
ZTR-8-12	2M-DIN	AC 230 V	●	X	X	12 V	0.66 A	X	X	X	●		
ZTR-15-12	3M-DIN	AC 230 V	●	X	X	4-8-12 V	2-1.5-1A	X	X	X	●		



EAN code  
 PSB-10-12: 8595188145022  
 PSB-10-24: 8595188143783  
 PS-30-R: 8595188136655

Technical parameters	PSB-10-12	PSB-10-24	PS-30-R
<b>Input</b>			
Voltage range:	AC 110 - 250 V (50/60 Hz)	AC 100 - 250 V (50/60 Hz)	
Burden without load (max.):	3 VA/0.5 W		10 VA/1.7 W
Burden with full load (max.):	26 VA/13 W		70 VA/37 W
Protection:	x		fuse T2A
<b>Output</b>			
Output voltage DC/max. current:	12 V / 0.84 A	24 V / 0.42 A	12.2 V/2.5 A 24.2 V/1.25 A
Tolerance of output voltage:	± 2%		± 3%
Output indication:	x		green LED
Wave of off-load output voltage:	40 mV		40 mV
Wave of output voltage with max load:	380 mV		500 mV
Time delay after connection:	max. 1s		max. 1s
Time delay after over-load:	max. 1s		max. 1s
Efficiency:	> 75%		> 81%
Electronic fuse:	against short circuit, current and temperature overload (from 120% of rated power)		
<b>Other information</b>			
Working humidity:	20 to +90 % RH		
Operating temperature:	-20 to +40 °C (-4 °F to 104 °F)		
Storage temperature:	-40 to +85 °C (-40 °F to 185 °F)		-25 to +70 °C (-13 to 158 °F)
Dielectrical strength input- output:	4kV		
Protection degree:	IP30		IP40 front panel I/IP20 terminals
Overvoltage category:	II.		
Degree of pollution:	2		
Cross section of connecting wires (mm2):	x		max. 1x 2.5, max. 2x 1.5/s dut.max. 1x 1.5
Outlets (cross section/length):	wire CY, 4x 0.75mm <sup>2</sup> , 90mm (3.5")		x
Dimensions:	49 x 49 x 21 mm (1.9" x 1.9" x 0.83")		90 x 52 x 65 mm (3.5" x 2" x 2.6")
Weight:	78 g (2.8 oz.)	78 g (2.8 oz.)	163 g (5.7 oz.)
Standard:	EN 61204-1, EN 61204-3, EN 61204-7		

- **PSB-10:** switched stabilized power supplies with fixed output voltage, designed for mounting in the installation box.
- **PSB-10-12:** stabilized power supply 12 V/10 W
- **PSB-10-24:** stabilized power supply 24 V/10 W.
- **PS-30-R:** switching stabilized adjustable power supply 12-24 V/30 W
- The output current is limited by an electronic fuse, when the maximum current is exceeded, the source switches off and switches on again after a short time delay.
- Thermal protection - in case of thermal overload the source switches off, after cooling it switches on again

Device description

PSB-10-12

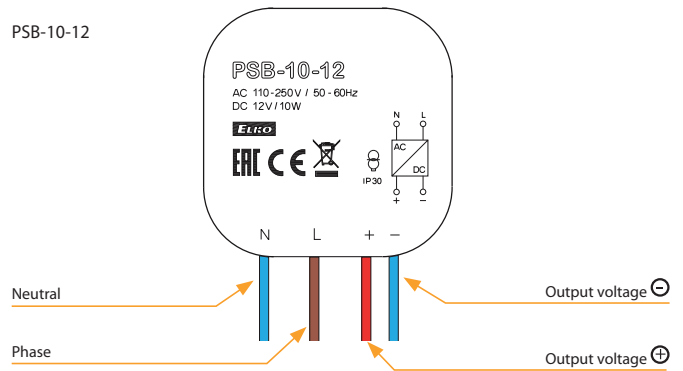

PSB-10-12/PSB-10-24

designated for installation into an installation box. Suitable for controlling of lighting sources, thermo valves, shutter engines, etc.

PS-30-R

Supply terminals (N- L)

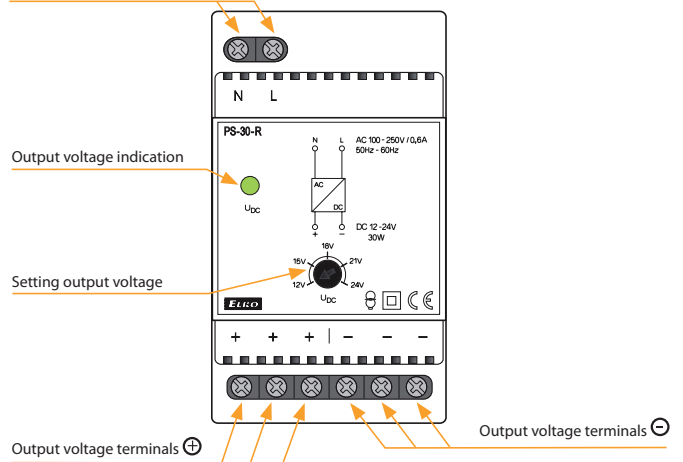

Connection

PSB-10-12 (PSB-10-24)

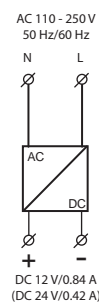

PS-30-R

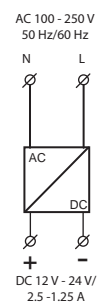

NEW



EAN code  
 PS1M-15/12V: 8595188180474  
 PS1M-15/24V: 8595188180481  
 PS2M-24/12V: 8595188180498  
 PS2M-30/24V: 8595188180504  
 PS3M-54/12V: 8595188180511  
 PS3M-60/24V: 8595188180528  
 PS4M-85/12V: 8595188180535  
 PS4M-92/24V: 8595188180542

- Rated output voltage 12 or 24V DC with the possibility of regulation.
- High efficiency of up to 90%.
- Low ripple & noise.
- Protection: Over load , Over voltage and Short circuit.
- Continuously adjustable output voltage to adapt to the specific application, e.g. the need to compensate for the voltage drop caused by the length of the line.

Technical parameters	PS1M-15/12V	PS1M-15/24V	PS2M-24/12V	PS2M-30/24V	PS3M-54/12V	PS3M-60/24V	PS4M-85/12V	PS4M-92/24V
----------------------	-------------	-------------	-------------	-------------	-------------	-------------	-------------	-------------

Input								
Voltage range:	AC 100 - 240 V (50/60 Hz)							
Tolerance:	± 10%							
Efficiency:	85%	86%	88%	89%	88%	90%	88%	90%
Burden without load (max.):	0.3W/4VA	0.5W/4VA	0.3W/8VA	0.4W/8VA	0.3W/7VA	0.5W/6.5VA	0.4W/11VA	0.1W/12VA
Burden with full load (max.):	16W/30VA	17.5W/32VA	30W/50VA	33W/60VA	60W/95VA	70W/111VA	95W/150VA	105W/160VA
Inrush current:*	max. 25A at 115V AC/60Hz max. 45A at 240V AC/50Hz				max. 30A at 115V AC/60Hz max. 60A at 240V AC/50Hz		max. 35A at 115V AC/60Hz max. 70A at 240V AC/50Hz	

Output								
Rated voltage:	12V DC	24V DC	12V DC	24V DC	12V DC	24V DC	12V DC	24V DC
Vol. setting range:	11 - 13V	23 - 25V	11 - 13V	23 - 25V	11.4 - 12.6V	22.8 - 25.2V	11 - 13V	23 - 25V
Rated current:	1.25A	0.625A	2A	1.25A	4.5A	2.5A	7.1A	3.83A
Rated power:	15W	15W	24W	30W	54W	60W	85.2W	92W
Ripple & Noise:	120mV	150mV	120mV	150mV	120mV	150mV	120mV	150mV
Output indication:	blue LED		blue LED		green LED		blue LED	
Tolerance of output voltage:	5 %							
Overload protection:	from 130 % - 200% rated output power							
Overvoltage protection:	from 110 % - 145% rated output power							
Overcurrent protection:	from 110 % - 180% rated output power							
Short circuit protection:	temporarily disconnecting the output							

Other information								
Operating temperature:	-20°C to +50°C (-4 °F to 122 °F)							
Operating humidity:	20% ~ 90% RH non-condensing							
Storage temperature:	-40°C to +80°C (-40 °F to 176 °F)							
Dielectric strength:	3kV AC							
Isolation resistance:	100M Ω/500V DC/25°C (77°F)/70% RH							
Overvoltage category:	III.							
Pollution degree:	2							
Max. cable size:	max. 1x 2.5 mm <sup>2</sup> , max. 2x 1.5 mm <sup>2</sup> solid wire/with sleeve max. 1x 2,5 mm <sup>2</sup>							
Terminal torque:								
input terminals	0.5 Nm		0.3 Nm		0.3 Nm		0.3 Nm	
output terminals	0.5 Nm							
Protection degree:	IP20							
MTBF:	200 000 hours minimum, full load at 25°C ambient temperature							
Mounting:	DIN rail EN 60715							
Dimensions:	90 x 18 x 58 mm (3.5" x 0.71" x 2.3")		90 x 35 x 58 mm (3.5" x 1.4" x 2.3")		90 x 52.5 x 58 mm (3.5" x 2.1" x 2.3")		90 x 70 x 58 mm (3.5" x 2.8" x 2.3")	
Weight:	78 g (2.8 oz.)		120 g (4.2 oz.)		190 g (6.7 oz.)		270 g (9.5 oz.)	
Standards:	IEC60950-1, UL508, TUV EN61558-2-16							

\* the stated values are valid for the full load from the source

Description

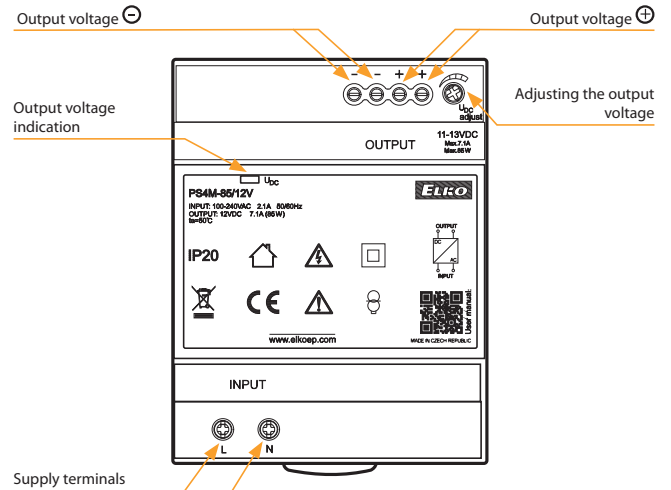
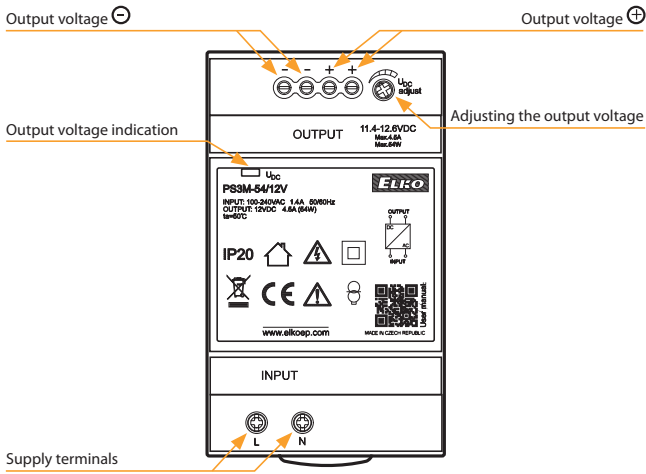
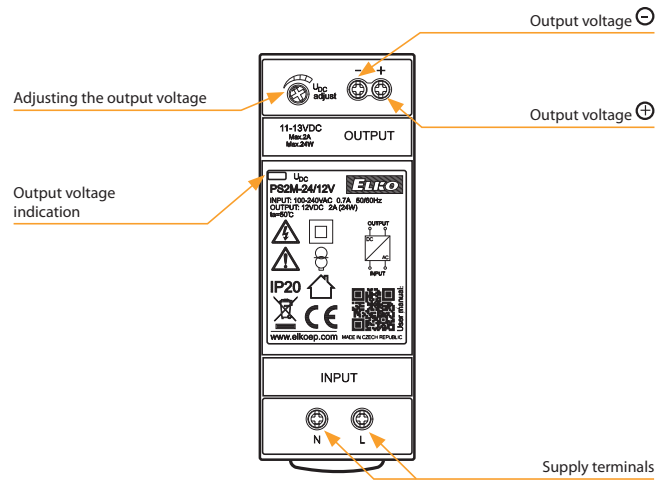
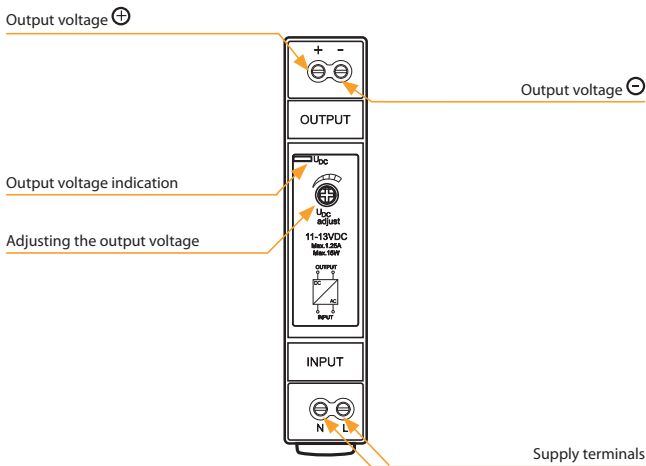

Connection

PS1M-15/12V  
(PS1M-15/24V)

DC 12 V/1.25 A  
(DC 24 V/0.625 A)

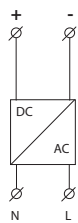

AC 100 - 240 V  
50 Hz/60 Hz

PS2M-24/12V  
(PS2M-30/24V)

DC 12 V/2 A  
(DC 24 V/1.25 A)

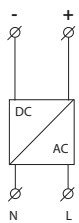

AC 100 - 240 V  
50 Hz/60 Hz

PS3M-54/12V  
(PS3M-60/24V)

DC 12 V/4.5 A  
(DC 24 V/2.5 A)

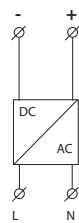

AC 100 - 240 V  
50 Hz/60 Hz

PS4M-85/12V  
(PS4M-92/24V)

DC 12 V/7.1 A  
(DC 24 V/3.83 A)

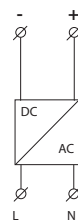

AC 100 - 240 V  
50 Hz/60 Hz



EAN code  
ZNP-10-24V: 8594030334089  
ZSR-30: 8594030331750

Technical parameters	ZSR-30	ZNP-10-24V
<b>Entry (U prim)</b>		
Voltage range:	AC 230 V (50/60 Hz)	
Consumption without load (max):	9 VA/2.5 W	9 VA/2 W
Consumption with load (max):	11.5 VA/8 W	
Supply voltage tolerance:	-15 %; +10 %	
<b>Output (Usec)</b>		
Output voltage:	DC 5-24 V stab. DC 24 V nonstab. AC 24 V	DC 24 V nonstab. AC 24 V
Output voltage-no load AC:	32 V	
Output voltage-no load DC:	44 V	
Fuse:	primary wind T100 mA	
Wave of output voltage:	300 mV	max. 3 V
Efficiency:	75 %	x
Tolerance of output voltage:	±5 %	x
Electronic fuse:	Towards black-out and and current overloading	x
<b>Other information</b>		
Operating temperature:	-20 to +40 °C (-4 °F to 104 °F)	
Storing temperature:	-20 to +60 °C (-4 °F to 140 °F)	
Dielectrical strenght (prim/sec):	4 kV	
Protection degree:	IP40 from front panel/IP20 terminals	
Max. cable size (mm <sup>2</sup> ):	solid wire max. 1x 2.5 or 2x 1.5/ with sleeve max. 1x 1.5 (AWG 12)	
Dimensions:	90 x 52 x 65 mm (3.5" x 2" x 2.6")	
Weight:	398 g (14 oz.)	368 g (13 oz.)
Standards:	EN 61204-1, EN 61204-3, EN 61204-7	

**WARNING!**  
Values of max. load are valid for (operational) temperature.  
Total loads on all output terminals may not exceed this values:  
- by supplying 230 V-253 V - 8W  
- from 230 V to 207 V output power is proportionately decreasing onto 5 W

**Regulated stabilized power supply ZSR-30**

- Supply of various devices and appliances by safe voltage with fully galvanic separation from the main.
- Output voltage: DC 5-24 V stab., DC 24 V unstab. and AC 24 V.
- Exceeded current limit values is indicated by LED flashing.
- When there is full short-circuit, output is disconnected, output current is limited by an electronic fuse.

**Nonstabilized power supply ZNP-10-24V**

- AC and DC output voltage 24 V, nonstabilized.
- Power supply with fixed output voltage.
- Protection against short-circuit and overload by a safety fuse.

**Description**

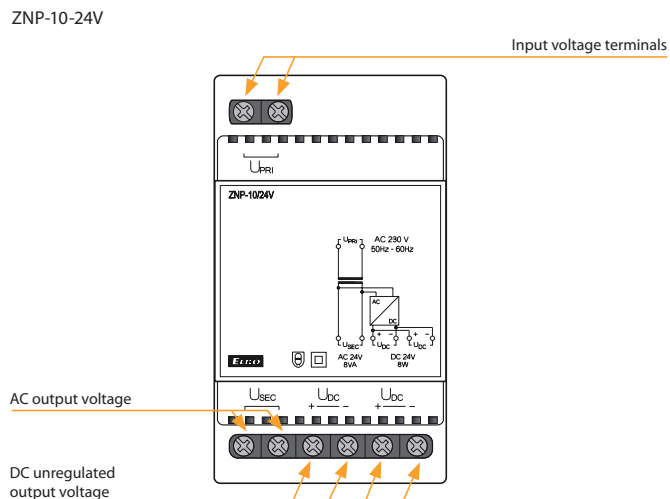
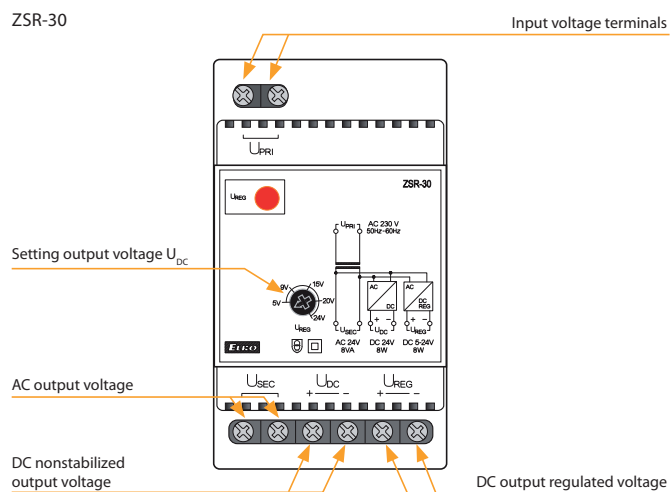

**Connection**

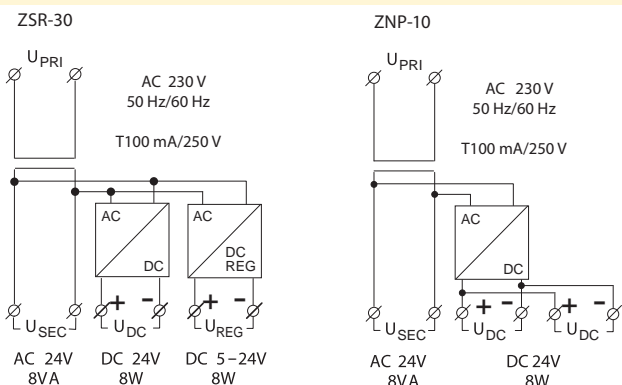





EAN code  
 ZTR-8-8V: 8595188136808  
 ZTR-8-12V: 8595188136815  
 ZTR-15-12V: 8595188139281

Technical parameters	ZTR-8-8	ZTR-8-12	ZTR-15-12
<b>Entry (U prim)</b>			
Voltage range:	AC 230 V (50 Hz)		
Max. dissipated power (Un + terminals):	1.5 W	1.5 W	2 W
Supply voltage tolerance:	± 10 %		
Consumption without load (max):	70 %		
<b>Output (Usec)</b>			
Output voltage:	AC 8 V	AC 12 V	AC 4 V AC 8 V AC 12 V
Output voltage-no load AC:	12 V	16 V	16 V
Max. loadability:	8 A	8 VA	4V 5VA, 8V 10 VA, 12 V 15VA
Fuse:	short-circ.resistant		
<b>Other information</b>			
Operating temperature:	-20 to +40°C (-4 °F to 104 °F)		
Storing temperature:	-20 to +60°C (-4 °F to 140 °F)		
Dielectrical strenght (prim/sec):	4 kV		
Protection degree:	IP20/40		
Max. cable size (mm <sup>2</sup> ):	solid wire max. 1x 2.5 or 2x 1.5/ with sleeve max. 1x 1.5 (AWG 12)		
Dimensions:	90 x 35.6 x 64 mm (3.5" x 1.4" x 2.6")	90 x 52 x 65 mm (3.5" x 2" x 2.6")	
Weight:	337 g (11.9 oz.)	345 g (12.2 oz.)	624 g (22 oz.)
Standards:	EN 61558-1, EN 61558-2-8		

- Designated for general use – e.g. for home bells supply, door locks supply.
- Universal power supply with AC input voltage.
- Short-circuit-proof, doubled output terminals.
- 2-MODULE, DIN rail mounting.  
 ZTR-8-8: output voltage 8 V.  
 ZTR-8-12: output voltage 12 V.
- 3-MODULE, DIN rail mounting.  
 ZTR-15-12: output voltage 4, 8,12V.

Connection

ZTR-8-8

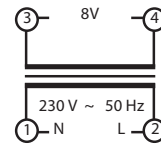

ZTR-8-12

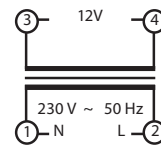

ZTR-15-12

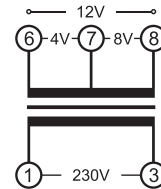

R, L, C, ESL, LED<sup>2</sup>**DIM-15**

Designated for dimming of:  
dimmable energy saving  
fluorescent lamps,  
LED lamps.

R, L, C, - resistive, inductive  
and capacitive loads.  
page 76

**SMR-M**

For mounting under  
a wall-switch into an  
installation box KU-68  
(or similar). Dimmable  
energy saving fluorescent  
lamps, LED lamps.

R, L, C, - resistive,  
inductive and capacitive  
loads.  
page 76

R, L, LED<sup>1</sup>**DIM-2**

Staircase switch with  
gradual dimming up/  
down, level and time of  
illumination, all values are  
adjustable.

R = 10 -500 VA  
L = 10 -250 VA.  
page 78

**SMR-S**

As DIM-5, but for mount-  
ing under a wall-switch  
into an installation box  
KU-68 (or the similar),  
3-wire connection  
(without neutral).

R = 10-300 VA  
L = 10-150 VA.  
page 79

R, L, C, LED<sup>2</sup>**DIM-6**

Power dimming to 2kW.  
Can be controlled  
by button, external  
potentiometer, 0-10 V  
(1-10 V) system iNELS.

R = 2000 VA  
L = 2000 VA  
C = 2000 VA.  
page 80

**DIM6-3M-P**

DIM6-3M-P is a power  
module expansion unit  
for DIM-6. It cannot be  
operated independently.

R = 1000 VA  
L = 1000 VA  
C = 1000 VA.  
page 81

R, L, C, ESL, LED<sup>2</sup>**RFDEL-76M**

Universal six-channel dimmer with  
a load capacity of up to 150VA/  
channel (230V version) The dimmer  
channels can be connected in  
parallel and thus increase the  
possible load up to a maximum  
of 900VA. Each channel has a  
separate, galvanically isolated  
control input.  
page 84

R, L, C, ESL, LED<sup>2</sup>**LIC-1**

Intensity controller for  
maintaining the constant  
illumination level.  
Dimmable energy saving  
fluorescent lamps,  
LED lamps.

R, L, C, - resistive,  
inductive and capacitive  
loads.  
page 82

**LIC-2**

Serves as control unit for  
dimmers or electronic  
ballasts with analog  
control 0-10 V/1-10 V.  
page 83





**Accessories for  
LIC-1, LIC-2****SKS-100**

Photosensor for wall / panel  
mounting. IP65 protection.  
EANcode:8595188180733

Type	Design	Supply voltage	Type of dimmed load						Output unit	Output			Method of phase regulation		Control principal 0-10 V/1-10V	Designation	Catalogue page
			R <small>resistive (el. bulbs, halogen lights)</small>	L <small>inductive (wound transformers)</small>	C <small>capacitive (electronic transformers)</small>	ESL <small>energy saving fluorescent lamps</small>	LED <sup>1,2</sup> <small>LED lamps</small>	Rated load			ON-DIMMER	OFF-DIMMER					
								R		L			C				
DIM-15	1M-DIN	AC 230 V	●	●	●	●	●	2x MOSFET	300 VA	300 VA	300 VA	●	●	x	Universal dimmer R, C, L, ESL, LED <sup>2</sup> , button control,	76	
SMR-M	BOX	AC 230 V	●	●	●	●	●	2x MOSFET	160 VA	160 VA	160 VA	●	●	x	Like DIM-15, but for mounting under the push-button into the installation box (e.g. KU-68).		
DIM-2	1M-DIN	AC 230 V	●	●	x	x	●	triac	10-500 VA*	10-250 VA	x	●	x	x	Stairway automaton with progressive illumination on/off, adjustable rise time, delay, deceleration, maximum brightness. Dimmer R, L, LED <sup>1</sup> .	78	
DIM-6	6M-DIN	AC 230 V	●	●	●	x	●	4x MOSFET	2 000 VA*	2 000 VA*	2 000 VA*	●	●	●	Universal dimmer 2kW R, C, L, LED <sup>2</sup> , power expandable, pushbutton control/0-10V/1-10V/potentiometer/INELS bus.	80	
DIM6-3M-P	3M-DIN	AC 230 V	●	●	●	x	●	2x MOSFET	1 000 VA*	1 000 VA*	1 000 VA*	●	●	x	Expansion power module 1kW to DIM-6 dimmer.	81	
SMR-S	BOX	AC 230 V	●	●	x	x	●	triac	10-300 VA*	10-150 VA	x	●	x	x	Like DIM-5, but for mounting under the push-button into the installation box (e.g. KU-68).	79	
LIC-1	1M-DIN	AC 230 V	●	●	●	●	●	2x MOSFET	300 VA*	300 VA*	300 VA*	●	●	x	Universal dimmer R, C, L, ESL, LED <sup>2</sup> , button control, constant light level control.	82	
LIC-2	1M-DIN	AC 100-250 V	x	x	x	x	x	x	x	x	x	x	x	●	Controller for dimmers or electronic ballasts with 0-10 V/1-10V control, button control, constant light level control.	83	
RFDEL-76M	6M-DIN	AC 230/-120 V	●	●	●	●	●	12x MOSFET	6x 150 VA (230V)	6x 150 VA (230V)	6x 150 VA (230V)	●	●	x	Load capacity 150VA/channel (230V version) or possibility to connect up to max. 900VA in parallel at the expense of the number of channels Each channel has a separate, galvanically separated input	84	

\* with load over 300 VA is necessary to ensure sufficient cooling

**Key to symbols**

TYPE OF LOAD (symbols)	bulbs, halogen lamps	low-voltage el.bulbs 12/24V wound transformers	low-voltage el.bulbs 12/24V electronic transformers	ESL dimmable compact fluorescent lamps	Dimmable LED bulbs
					
	R	L	C	ESL	LED <sup>1,2</sup>

Demonstrated symbols are informative

**Expandatory:**



- Dimmer with designated load:
- R - resistive
- L - inductive
- C - capacitive
- ESL - energy saving bulbs
- LED<sup>1</sup> - dimmable LED bulbs, designed for dimmers with phase-controlled rising edge (triac dimmers)
- LED<sup>2</sup> - dimmable LED bulbs designed for dimmers with phase or phase-to-phase phase control (dimmers with MOSFET)

IPxx protection - under normal conditions: normal conditions are understood as such conditions of operating an electrical device, installation and power supply network for which the entire device is designed, produced and installed. Upon these normal conditions of use and upon normal maintenance, all protective devices must be effective throughout the entire expected service life of the product.

Recommendation for mounting modular dimmers: leave a gap of min. 0.5 module (approx. 9 mm / 0.4") on side of the device to ensure better cooling of the device.



EAN code  
DIM-15/230 V: 8595188140690  
SMR-M: 8595188143776

Technical parameters	DIM-15	SMR-M
Supply terminals:	A1 - A2	x
Voltage range:	x	4-wire, with neutral
Operating range:	AC 230 V/50 Hz	
Burden (unloaded):	max. 2 VA/0.55 W	max. 0.66 VA/0.55 W
Max. dissipated power:	2 W	3 W
Supply voltage tolerance:	-15 %; +10 %	
Supply indication:	green LED	
<b>Control</b>		
Control terminals:	A1 - T	x
Control wire:	x	L - S
Control voltage:	AC 230 V	
Control input power:	AC 0.3 - 0.6 VA	
Control impulse length:	min. 80 ms/max. unlimited	
Glow tubes connection:	Yes	
Max. amount of glow lamps connected to controlling input:	max. 15 pcs (measured with glow lamp 0.68 mA/230 V AC)	max. 10 pcs (measured with glow lamp 0.68 mA/230 V AC)
<b>Output</b>		
Contactless:	2 x MOSFET	
Load:	300 W (at $\cos \varphi = 1$ )*	160 W (at $\cos \varphi = 1$ )*
Output status indication:	red LED	x
<b>Other information</b>		
Operating temperature:	-20 °C to +35 °C (-4 °F to 95 °F)	
Storing temperature:	-20 °C to +60 °C (-4 °F to 140 °F)	
Operating position:	any	
Mounting:	DIN rail EN 60715	free at connecting wires
Protection degree:	IP40 from front panel/ IP10 clips	IP 30 in standard conditions**
Overvoltage category:	III.	
Pollution level:	2	
Terminal wire capacity (mm <sup>2</sup> ):	max. 2x2.5, max. 1x 4 with sleeve max. 1x2.5, max. 2x1.5 (AWG 12)	x
Connection wires (cross-section/length):	x	CY, 0.75 mm <sup>2</sup> (AWG 18)/ 90 mm (3.5")
Dimensions:	90 x 17.6 x 64 mm (3.5" x 0.69" x 2.5")	49 x 49 x 21 mm (1.9" x 1.9" x 0.83")
Weight:	58 g (2 oz.)	33 g (1.2 oz.)
Standards:	EN 60669-1, EN 60669-2-1	

\* Due to a large number of light source types, the maximum load depends on the internal construction of dimmable light sources and their power factor  $\cos \varphi$ . The power factor of dimmable LEDs and ESL bulbs ranges from  $\cos \varphi = 0.95$  to 0.4. An approximate value of maximum load may be obtained by multiplying the load capacity of the dimmer by the power factor of the connected light source.

\*\* For more information see page 75.

Warning: it is not allowed to connect inductive and capacitive loads at the same time.

- Designed for dimming of incandescent bulbs and halogen lights with wound or electronic transformer, dimmable light bulbs and dimmable LED<sup>2</sup>.
- Enables gradual setting of luminance by push-button (non-detent) or parallel buttons.
- Returns to last state upon re-energization.
- Type of light source is set by switch-over on the front panel of device.
- Min. luminance, set by potentiometer on the front panel, eliminates flashing of light sources.

LED<sup>2</sup>: more informations on page 75

## Connection

DIM-15

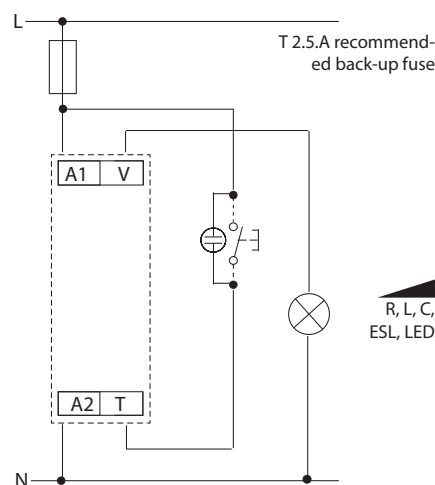

SMR-M

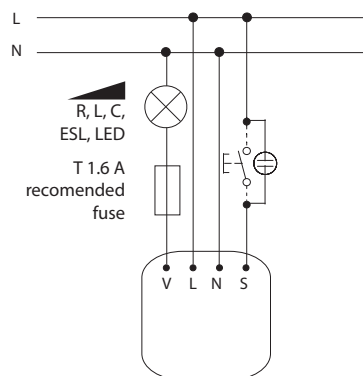

## Symbol

DIM-15  
(SMR-M)

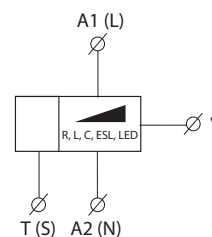

**Device description**

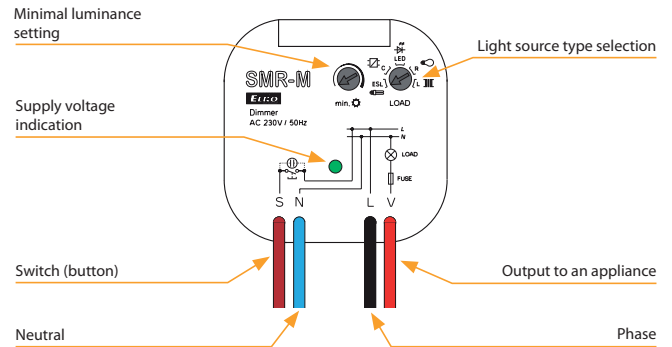
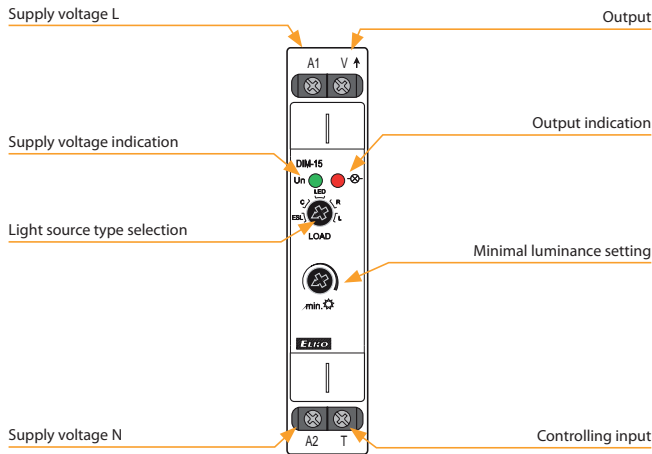

**Functions and controlling**

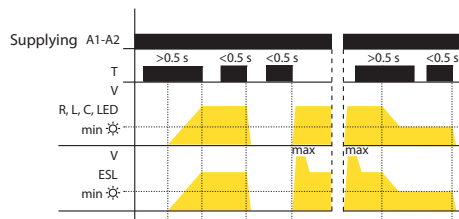

- short button press (<0.5 s) turns the light off or on
  - long press (>0.5 s) enables slight regulation of light intensity
  - setting of minimal luminance is possible only during decreasing of luminance by long button press
  - setting of minimal luminance by saving fluorescent lamps serves for harmonizing of lowest light intensity prior its unprompted switching off
- Luminance setting:  
LED, R, L, C:
- if the light is turned off, short press (<0.5 s) switches the light onto last set luminance level
- ESL:
- when light is off, short impulse turns lamp on and then luminance is decreased to set level

**Connection example**

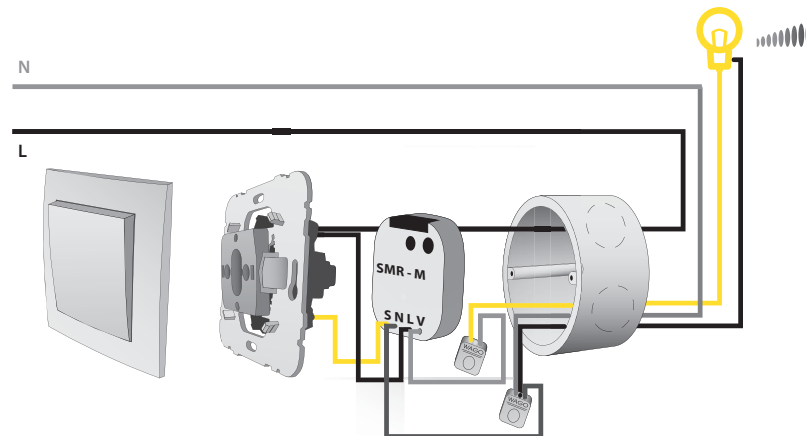

**Additional information**

- it is not possible to dim energy-saving lamps without marking: dimmable
- an incorrect setting of light source has effect only on dimming range, it means neither dimmer or load get damaged
- max. number of dimmable light sources depends on their internal structure
- it is not recommended to connect light sources with different types and brands, to one dimmer



EAN code  
DIM-2 /230V: 8595188112475  
DIM-2-1h /230V: 8595188135740

Technical parameters	DIM-2
Supply terminals:	A1 - A2
Voltage range:	AC 230 V/50 Hz
Burden (unloaded):	max. 8 VA/0.6 W
Max. dissipated power:	1.5 W
Supply voltage tolerance:	-15 %; +10 %
Supply indication:	green LED
Time setting by:	potentiometers
Time deviation:	10 % - mechanical setting
Repeat accuracy:	5 % - set value stability
Temperature coefficient:	0.01 %/°C, at = 20 °C (0.01 %/°F, at = 68 °F)
Recovery time:	max. 80 ms

#### Controlling T1 (button)

Terminals:	T1 - A1
Voltage:	AC 230 V
Power on control input:	max. 1.5 VA
Impulse length:	min.100 ms/max. unlimited
Glow-lamps:	Yes
Max. amount of glow lamps connected to controlling input:	230 V - max. amount 50 pcs (measured with glow lamp 0.68 mA/230 V AC)

#### Controlling T2 (switch)

Terminals:	T2 - A1
Voltage:	AC 230 V
Power on control input:	0.1 VA
Impulse length:	min.100 ms/max. unlimited

#### Output

Contactless	1x triac
Current rating:	2 A
Resistance load:	10 - 500 VA
Inductive load:	10 - 250 VA

#### Other information

Operating temperature:	-20 °C to +55 °C (-4 °F to 131 °F)
Storage temperature:	-30 °C to +70 °C (-22 °F to 158 °F)
Operating position:	any
Mounting:	DIN rail EN 60715
Protection degree:	IP40 from front panel/IP10 terminals
Overvoltage category:	III.
Pollution degree:	2
Max. cable size (mm <sup>2</sup> ):	solid wire max. 2x 2.5 or 1x 4/ with sleeve max. 1x 2.5 or 2x 1.5 (AWG 12)
Dimensions:	90 x 17.6 x 64 mm (3.5" x 0.7" x 2.5")
Weight:	64 g (2.3 oz.)
Standards:	EN 60669-1, EN 60669-2-1

#### Symbol

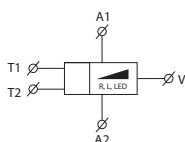

- Designated for dimming el. bulbs, halogen lights and halogen lights with winding transformers and Dimmable LED<sup>1</sup>.
- Intelligent control of halogen lights, function of gradual switching on and dimming.
- Controlling inputs for push button and switch.
- Values are set on front panel of the product, adjustable:
  - maximum dim-up
  - speed (fluency) of dim-up
  - speed (fluency) of dim-down
  - time for which a light is on with maximum dim-up.
- Output without contact: 1x triac.
- Parallel connection of controlling pushbuttons is possible.
- Protection against over-temperature inside the product - switches out-off + signalizes overheating by LED flashing.
- Note: possibility of start and finish adjustment up on 1 hour, device has description DIM-2 1h.

#### Description

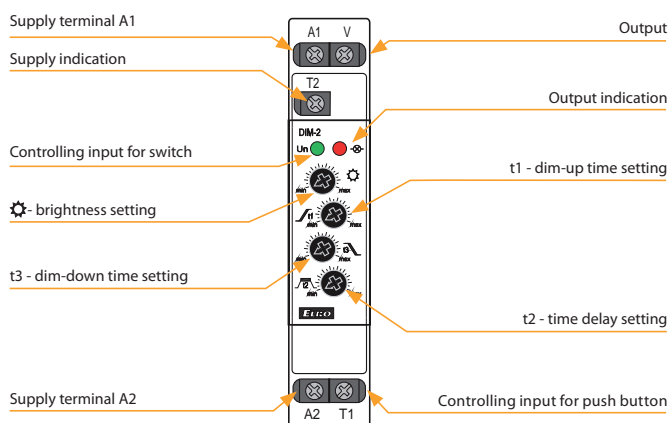

Recommendation for mounting: leave a gap of min. 0.5 module (approx. 9 mm,(0.3")) on side of the device to ensure better cooling of the device.

#### Connection

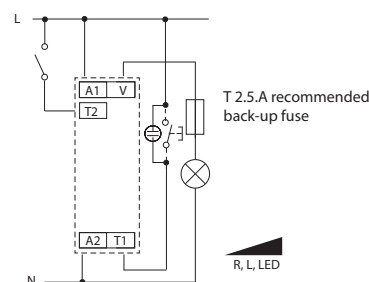

#### Function

##### Controlled via input T1 (button)

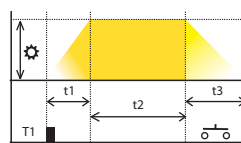

Dim-up delay-down is started by a button. Cycle extension - by re-pressing button (during the cycle).

##### Controlled via input T2 (switch)

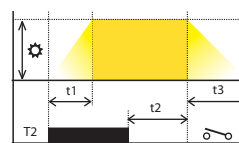

The switch starts the cycle and it stops on max.set brightness. After the switch is off, the cycle will continue until completed.

#### Legend:

- ☀ Brightness: 10 - 100 %
- t1 Dim-up time: 1 - 40 s
- t2 Time delay: 0 s - 20 min
- t3 Dim-down time: 1 - 40 s



EAN code  
SMR-S/230V: 8595188123518

Technical parameters		SMR-S
Connection:	3-wire con., without neutral	
Voltage range:	230 V AC (50 Hz)	
Burden (unloaded):	max. 0.66 VA/0.55 W	
Max. dissipated power:	3 W	
Supply voltage tolerance:	-15 %; +10 %	
<b>Output</b>		
Contactless:	1x triac	
Resistive load:	10 - 300 VA	
Inductive load:	10 - 150 VA	
Capacitive load:	x	
<b>Control</b>		
Control voltage:	AC 230 V	
Current:	max. 3 mA	
Impulse lenght:	min. 50 ms/max. unlimited	
Glow tubes connection:	Yes	
Max. amount of glow lamps connected to controlling input:	230 V - max. amount 10 pcs (measured with glow lamp 0.68 mA/230 V AC)	
<b>Other information</b>		
Operating temperature:	0 °C to +50 °C (32 °F to 122 °F)	
Operating position:	any	
Mounting:	free at connecting wires	
Protection degree:	IP30 in standard conditions*	
Overtoltage category:	III.	
Pollution degree:	2	
Fuse:	F 1.6 A/250 V	
Connection wires:	solid wires 0.75 mm <sup>2</sup> (AWG 18)/90 mm (3.5 inch)	
Glow lamps in a button:	max. number 10	
Dimensions:	49 x 49 x 13 mm (1.9" x 1.9" x 0.5")	
Weight:	30 g (1.06 oz.)	
Standards:	EN 60669-1, EN 60669-2-1	

\* for more information see page 75

- Button-controlled dimmers designated for flush mounting into a wiring box.
- Possible to control from more places (parallel connections).
- Protection against temperature overrun inside the device.
- Designated for dimming el. bulbs, halogen lights and halogen lights with winding transformers and Dimmable LED<sup>1</sup>.
- 3-wire connection, functional without neutral.
- Max. load: 300 VA (el. bulbs or halogen lights with wound transformer).
- Contactless output -1x triac.
- With exchangeable fuse.

Description of SMR-S

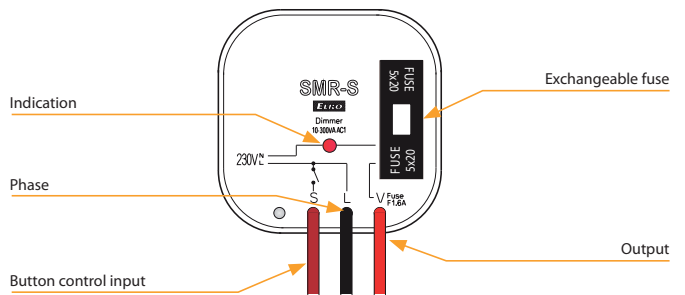

Connection

Typical connection of SMR-S - dimmer of lights

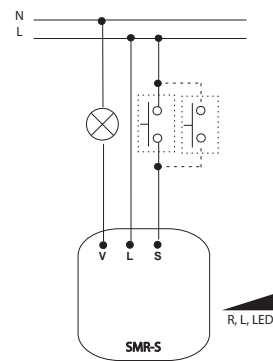

Warning: it cannot be used for fluorescent lights and energy saving lights!

Function

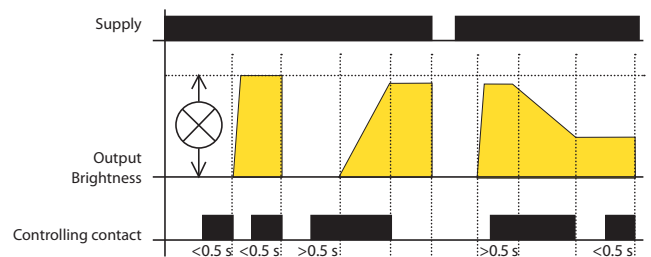

Short press (<0.5 s) turns a light on, another short press turns it off. A longer press (>0.5 s) causes a gradual regulation of light intensity min-max-min round until the button is released. After releasing a set intensity is kept in memory, further short presses turn the light on/off keeping the set intensity. The intensity can be changed by further long press. After de-energising the relay remembers the set value.

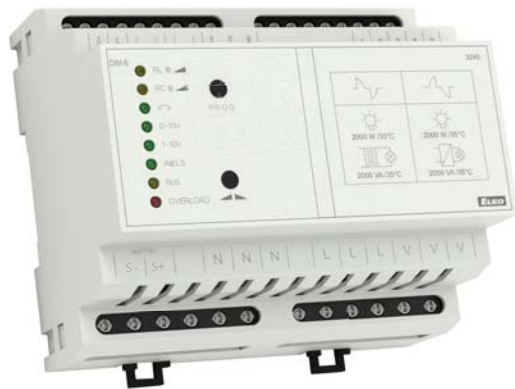

EAN code  
DIM-6 /230 V: 8595188136914

Technical parameters	DIM-6
Supply terminals:	L, N
Supply voltage:	AC 230 V (50 Hz)
Burden (unloaded):	max. 4 VA/3.2 W
Max. dissipated power:	6 W
Tolerance of voltage range:	-15 %; +10 %
Max. output power:	max. 2 000 VA
Module extendable:	to 10 000 VA
Galvanic separation of BUS and power output:	Yes
Isul. volt. between outputs and inner circuits:	3.75 kV, SELV according to EN 60950
<b>Control - button type</b>	
Control voltage:	AC/DC 12-240 V
Control terminals:	S-, S+, galvanically separated
Power of control input (max.):	0.53 VA (AC 12-240 V), 0.35W (DC 12-240V)
Length of control impulse:	min. 25 ms/max. unlimited
Recovery time:	max. 150 ms
Connection of glow lamps:	No
<b>Control 0(1)-10 V</b>	
Control terminals:	0(1)-10 V, GND
Control voltage:	0-10 V or 1-10 V
Min. current of control input:	1 mA
<b>BUS control:</b>	
Control terminals:	BUS+, BUS-
BUS voltage:	27 V DC
Current of control input:	5 mA
Indication of data transmission:	yellow LED
<b>Output</b>	
Contactless:	4 x MOSFET
Current rating:	10 A
Resistive load:	2 000 VA*
Inductive load:	2 000 VA*
Capacitive load:	2 000 VA*
Indication of output state:	yellow LED, according to load type
<b>Other information</b>	
Operating temperature:	-20 °C to +35 °C (-4 °F to 95 °F)
Storing temperature:	-30 °C to +70 °C (-22 °F to 158 °F)
Operating position:	vertical
Mounting:	DIN rail EN 60715
Protection degree:	IP40 from front panel
Purpose of control device:	operative control device
Construction of control device:	individual control device
Char. of automatic operation:	1.B.E
Heat and fire resistance cat.:	FR-0
Anti-stroke category (immunity):	class 2
Rated impulse voltage:	2.5 kV
Overvoltage category:	III.
Pollution level:	2
Profile of connecting wires (mm <sup>2</sup> )	
output part:	max.1x2.5, max. 2x1.5/with sleeve max. 1x1.5 (AWG 12)
control part:	max.1x2.5, max. 2x1.5/with sleeve max. 1x2.5 (AWG 12)
Dimensions:	90 x 105 x 65 mm (3.5" x 4.1" x 2.6")
Weight:	392 g (13.8 oz.)
Standards:	EN 60669-1, EN 60669-2-1

- Designed for dimming of incandescent bulbs and halogen lights with wound or electronic transformer and Dimmable LED<sup>2</sup>.
- DIM-6 control options:
  - button (parallel button connection)
  - external potentiometer
  - analog signal 0-10 V (1-10 V)
  - iNELS BUS system.
- The DIM-6 can connect up to 8 pieces of DIM6-3M-P and control up to 10.000 VA.
- Electronic overcurrent protection, overvoltage and short-circuit protection.
- Protection against over-heating inside device - switch off output + signalize overheat by flashing red LED.
- 6-MODULE version, DIN rail mounting.

## Description

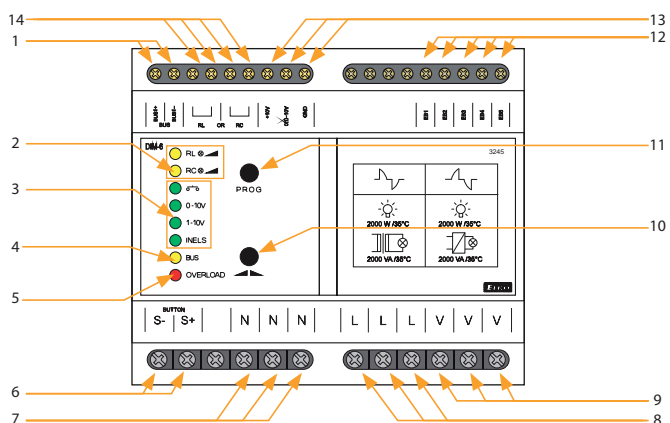

- |                                |   |   |
|--------------------------------|---|---|
| 1 Terminals for BUS connection | 6 Terminals for connecting control button | 11 Button for output control                                      |
| 2 Load type indication         | 7 Terminals of neutral wire               | 12 Terminal for additional modul conductor bar                    |
| 3 Control type indication      | 8 Terminal for phase conductor connection | 13 Terminals for control by signal 0(1)-10 V, or by potentiometer |
| 4 BUS data transfer indication | 9 Output terminals                        | 14 Terminal for regulation load of wire jumper                    |
| 5 Overload indication          | 10 Button for output control              |   |

## Types of indication LED

- RL - Yellow - indicates configuration of load RL
- RC - Yellow - indicates configuration of load RC
- Green - button control mode selected
- 0-10V - Green - 0-10 V signal control mode selected
- 1-10V - Green - 1-10 V signal control mode selected
- iNELS - Green - BUS conductor bar-iNELS control mode selected
- BUS - Yellow - indicates data transfer communication of BUS
- OVERLOAD - Red - indicates overload, flashing LED signalizes over-heating inside the device, shinning LED signalizes current overload

## Symbol

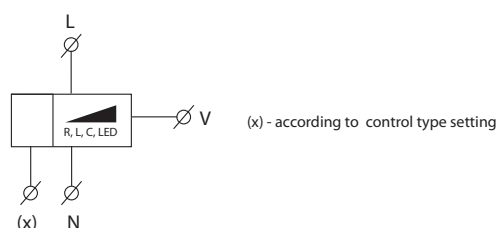

\* Warning: it is not allowed to connect inductive and capacitive loads at the same time.





EAN code  
DIM6-3M-P: 8595188139106

Technical parameters	DIM6-3M-P
Load:	max. 1 000 VA
Max. dissipated power:	6 W
<b>Output</b>	
Contactless:	2 x MOSFET
Current rating:	5 A
Resistive load:	1 000 VA*
Inductive load:	1 000 VA*
Load capacity:	1 000 VA*
<b>Other information</b>	
Operating temperature:	-20 °C to +35 °C (-4 °F to 95 °F)
Storing temperature:	-30 °C to +70 °C (-22 °F to 158 °F)
Operating position:	vertical
Mounting:	DIN rail EN 60715
Protection degree:	IP40 from front panel
Controlling device purpose:	operating control device
Controlling device construction:	additional control device
Automatic operating char.:	1.B.E
Heat and fire resistance category:	FR-0
Immunity category:	class 2
Rated impuls voltage:	2.5 kV
Overvoltage category:	III.
Pollution level:	2
Profile of connecting wires (mm <sup>2</sup> )	
output part:	max.1x2.5, max. 2x1.5/with sleeve max. 1x1.5 (AWG 12)
control part:	max.1x2.5, max. 2x1.5/with sleeve max. 1x2.5 (AWG 12)
Size:	90 x 52 x 65 mm (3.5" x 2" x 2.6")
Weight:	130 g (4.5 oz.)
Standards:	EN 60669-1, EN 60669-2-1

- Expanding power module only for use in combination with DIM-6.
- DIM6-3M-P provides power increase (of about 1 000 VA) of load connected to DIM-6 (it means: 2 000 VA (DIM-6) + 1 000 VA (DIM6-3M-P) = 3 000 VA).
- The DIM-6 can connect up to 8 pieces of DIM6-3M-P and control up to 10.000 VA (the load must be divided into individual power blocks so that their maximum power is not exceeded).
- Attention-device has to be protected by circuit breaker accordant to the load connected to device.
- DIM-6 in installation is cooled by natural air flow. If the natural air flow access is reduced, cooling has to be provided by ventilator. Rated operating temperature is 35 °C/95 °F.
- If there are several DIM6-3M-P connected to DIM-6, the distance between them has to be min. 2 cm/0.8".
- Max. length of BUS EB is 1 m/39.4" and the connection has to be realized by shielded cable.

**Device description**

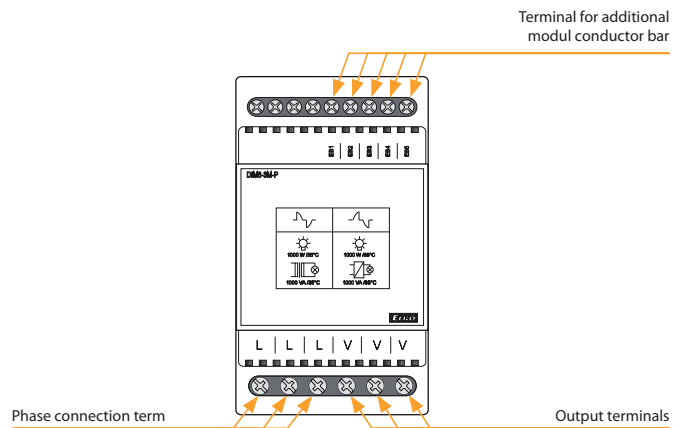

**Note**

The DIM-6 dimmer (L, V) terminals and the DIM6-3M-P expansion module are three-fold for easier multi-part loads.

\* Warning: it is not allowed to connect loads of inductive and capacitive character at the same time.

**Connection**

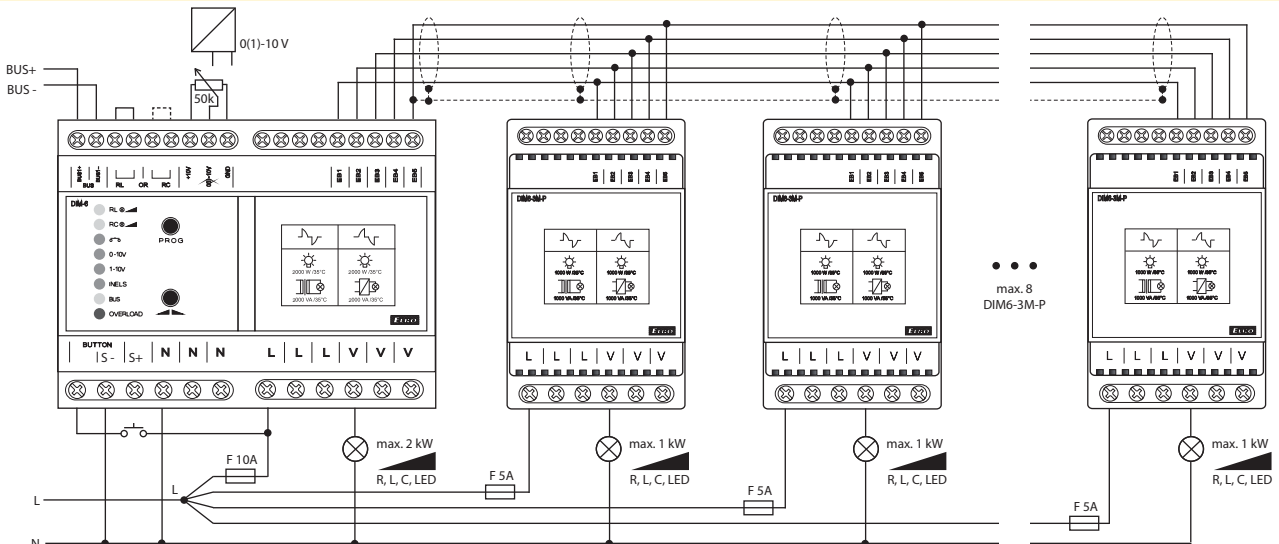

A quick fuse corresponding to the power of each module must be included in the L supply for each module.



EAN code  
LIC-1 + SKS-100: 8595188144933  
Photosensor SKS-100: 8594030337288

SKS-100

Technical parameters		LIC-1
Supply terminals:	A1 - A2	
Supply voltage:	AC 230 V (50/60 Hz)	
Burden (unloaded):	max. 1.6 VA/0.8 W	
Max. dissipated power:	1 W	
Supply voltage tolerance:	±15 %	
Power supply indication:	green LED	
Control		
Button - control. terminals:	A1 - T	
Control voltage:	AC 230 V	
Control input power:	max. 0.6 VA	
Control impulse length:	min. 80 ms/max. unlimited	
Glow tubes connection (terminals: A1 - T):	Yes	
Maximum number of connected glow lamps the control input:	230 V - max. amount 50 pcs (measured with glow lamp 0.68 mA/230 V AC)	
Blocking input - terminals:	A1 - B	
Control. voltage:	AC 230 V	
Suply:	max. 0.1 VA	
Connect glow-lamps (terminals A1 - B):	No	
Impulse length:	min. 80 ms/max. unlimited	
Output		
Output status indication:	2x MOSFET	
Load capacity:*	300 VA (at $\cos \varphi = 1$ )	
Other information		
Operating temperature:	-20 °C to +35 °C (-4 °F to 95 °F)	
Storage temperature:	-20 °C to +60 °C (-4 °F to 140 °F)	
Operating position:	any	
Mounting:	DIN rail EN 60715	
Ingress protection:	IP40 from front panel/IP10 terminals	
Overvoltage category:	III.	
Contamination degree:	2	
Connecting conductor cross-section (mm <sup>2</sup> ):	solid wire max. 2x 2.5 or 1x 4 with sleeve max. 1x 2.5 or 2x 1.5 (AWG 12)	
Dimensions:	90 x 17.6 x 64 mm (3.5" x 0.7" x 2.5")	
Weight:	66 g (2.33 oz.)	
Standards:	EN 60669-1, EN 60669-2-1	

\* Due to a large number of light source types, the maximum load depends on the internal construction of dimmable LEDs and ESL bulbs and their power factor  $\cos \varphi$ . The power factor of dimmable LEDs and ESL bulbs ranges from  $\cos \varphi = 0.95$  to 0.4. An approximate value of maximum load may be obtained by multiplying the load capacity of the dimmer by the power factor of the connected light source.

**Warning:** it is not allowed to connect inductive and capacitive loads at the same time.

- Designed for dimming of incandescent bulbs and halogen lights with wound or electronic transformer, dimmable light bulbs and dimmable LED<sup>2</sup>.
- Automatically regulates the intensity of light in a room.
- External sensor scans the intensity and based on the preset value it decreases or increases the brightness of light.
- Operating status:
  - 1 - Off
  - 2 - Automatic regulation
  - 3 - Cleaning (maximum level of illumination)
  - 4 - Setting the minimum lighting brightness
  - 5 - Setting the desired level of illumination.
- Optional connection of buttons with 50 neon lamps.

2

For more information, see page 75

## Description

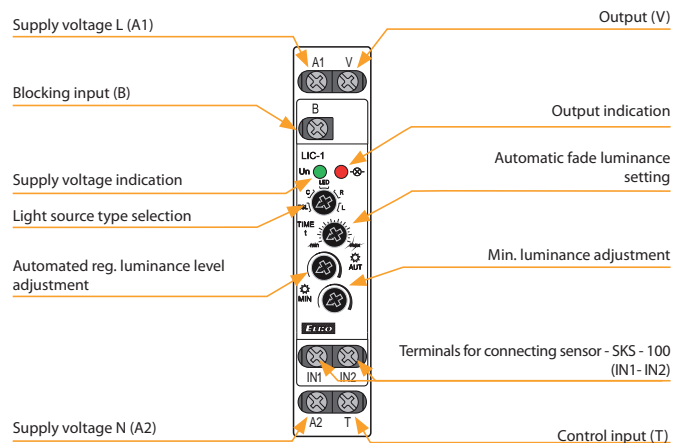

## Connection

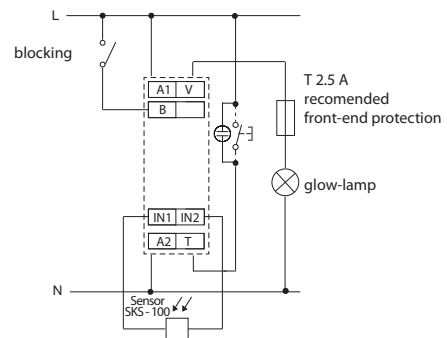

## Function

T-button control:

- pressing button shortly (< 0.5 s) always turns of lamp
- pressing button longer (0.5 to 3 s) turns on lamp in automatic regulation mode
- pressing button long (> 3 s) turns on lamp to full illumination - „cleaner“ mode
- after turning on the power supply, the dimmer is always turned off

Thyristor B:

serves to block automatic regulation (lamp turns off).

**WARNING!** The lamp may be turned on in “cleaner” mode even while blocked.

After ending block mode, the lamp remains off.

## Symbol

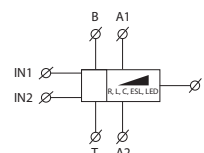



EAN code  
LIC-2 + SKS-100: 8595188145312  
Photosensor SKS-100: 8594030337288

Technical parameters		LIC-2
Supply terminals:	L - N	
Supply voltage:	AC 100 - 250 V (50/60 Hz)	
Consumption apparent / loss:	max. 2.7 VA/1.4 W	
Max. dissipated power (Un + terminals):	4 W	
Power supply indication:	green LED	
Control		
Button - control terminals:	L - T	
Control voltage:	AC 100 - 250 V	
Impulse length:	min. 80 ms/max. unlimited	
Glow tubes connection:	No	
Button - control terminals:	L - B	
Glow tubes connection:	No	
Duration of control pulse:	min. 80 ms/max. unlimited	
Output 1		
Analog:	0 - 10 V/10 mA max. or 1 - 10 V/10 mA max.	
Terminals:	OUT+, OUT-	
Galvanically separated:	Yes	
Output 2		
Number of contacts:	1x switching (AgSnO <sub>2</sub> )	
Current rating:	16 A/AC1	
Switching capacity:	4000 VA/AC1, 384 W/DC	
Peak current:	30 A/< 3 s	
Switching voltage:	250V AC/24V DC	
Output indication:	red LED	
Mechanical life:	30.000.000 operations	
Electrical life (AC1):	70.000 operations	
Other information		
Operating temperature:	-20 to +55 °C (-4 to 131 °F)	
Storage temperature:	-20 to +60 °C (-4 to 140°F)	
Operating position:	any	
Mounting:	DIN rail EN 60715	
Ingress protection:	IP40 from front panel/IP20 terminals	
Overvoltage category:	III.	
Contamination degree:	2	
Connecting cond. cross-section (mm <sup>2</sup> ):	max. 1x 2.5, max. 2x 1.5, with sleeve max. 1x 2.5 (AWG 12)	
Dimensions:	90 x 17.6 x 64 mm (3.5" x 0.7" x 2.5")	
Weight:	79 g (2.8 oz.)	
Standards:	EN 60669-1, EN 60669-2-1	

- Serves as control unit for dimmers or electronic ballasts with analog control 0-10 V / 1-10 V.
- Keeps a preset lighting intensity (automatic regulation).
- Control operating modes using existing button:
  - switch OFF
  - automatic regulation
  - cleaning (maximum illumination level).
- Setting the basic parameters of lighting is performed by potentiometers:
  - min. brightness of illumination
  - maximum illumination level
  - speed of dimming/illumination.

**Device description**

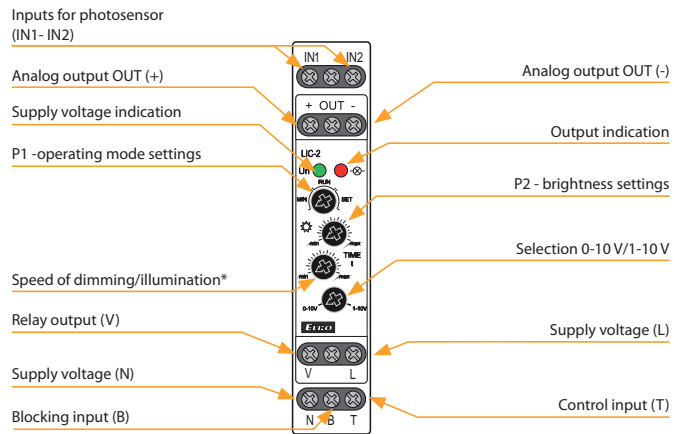

\* if the level of brightness on P2 is set on maximum the range is 24 to 120 s

**Connection**

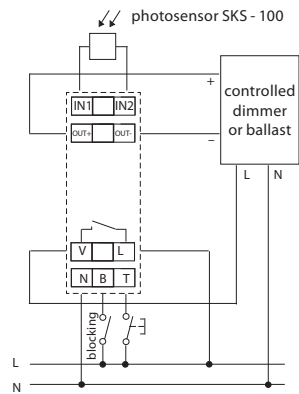

**Functions**

- Control button functions**
- short press (< 0.5 s) - always switches off output (relay and output voltage)
  - longer press (0.5 to 3 s) - runs automatic regulation of brightness level (according to sensor)
  - long press (> 3 s) - sets the max. brightness level (CLEANING mode).

**Blocking input function**

- switches off lighting - only in automatic regulation mode (has no influence in CLEANING mode), e.g. for central switching off of lighting.

**Output relay**

- switches on always upon switching on the lighting using the button if the DC output voltage is greater than 0.1 V (for the mode 0-10 V) or 1V (for the mode 1-10 V)
- upon switching off the light, the relay opens if the output voltage drops below the stated limits

**Red LED**

- illuminates upon active output (at any brightness level)
- flashes upon activation of blocking

**Symbol**

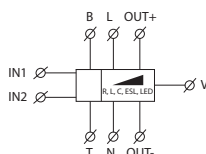



EAN code  
RFDEL-76M /230: 8595188182058  
RFDEL-76M /120: 8595188182096

**Technical parameters** RFDEL-76M/230V RFDEL-76M/120V

Supply voltage:	230 V AC	120 V AC
Supply voltage frequency:	50 Hz	60 Hz
Power supply indication:	green LED Un	
Supply voltage tolerance:	+10/-15 %	

**Output**

Output:	12x MOSFET transistor	
Load type *:	R - resistive, L - inductive, C - capacitive, ESL - economical, LED	
Minimum output power:	10 VA	
Max. output power / channel:	150 VA	75 VA
Possible to connect outputs:	Ano	
Maximum power when connecting all outputs:	max. 900 VA	max. 450 VA
Output protection:	thermal/short-term overload/longterm overload/short circuit	
Output indication:	red LED STATUS	

**Control**

Wired buttons:	up to 32 channels (with iNELS RF buttons) potential "L" or external voltage
Wireless	AC 20-230 V (50-60Hz)/DC 20-230 V
Communication protocol:	RFIO2
Function repeater:	yes
Range:	in the open up to 160 m (524.11 ft)
RF antenna:	AN-I included (SMA connector)

**Other information**

Operating temperature:	-20 to + 50 °C (-4 to 122 °F)
Storage temperature:	-30 to +70 °C (-22 to 158 °F)
Ingress protection:	IP20 under normal conditions
Overvoltage category:	II.
Contamination degree:	2
Connecting conductor:	max. 2.5mm <sup>2</sup> /1.5 mm <sup>2</sup> with sleeve
Operating position:	vertical
Installation:	in the switchboard on DIN rail EN 60715
Dimensions:	90 x 105 x 65 mm (3.5" x 4.1" x 2.6")
Weight	320 g (11 oz.)
Standards:	ČSN EN 63044-1 ETSI, ČSN EN 300 220-2, ETSI ČSN EN 301489-3

\*Warning: it is not allowed to simultaneously connect loads of inductive and capacitive type in the same channel.

- RFDEL-76M is a universal 6-channel actuator, which is used to control the brightness intensity of dimmable sources R - L - C - LED - ESL.
- The maximum possible load is 150 VA for 230 V and 75 VA for 120 V for each channel.
- The individual channels of the dimmer can be connected in parallel and thus increase the maximum output load at the expense of the number of outputs.
- Each of the output channels is individually controllable and addressable.
- By setting the min. brightness eliminates flickering of different types of light sources, setting min. brightness and type of load is done using the PROG buttons.
- Electronic overcurrent, thermal and short-circuit protection, which switches off the output.
- 6 galvanically isolated inputs for wired buttons, which can be used to control the outputs independently of the RF.
- Communication with bidirectional RFIO2 protocol. The package includes an internal AN-I antenna, in case of placement of a sheet metal distribution element, you can use an external AN-E antenna to improve the signal.

**Description**

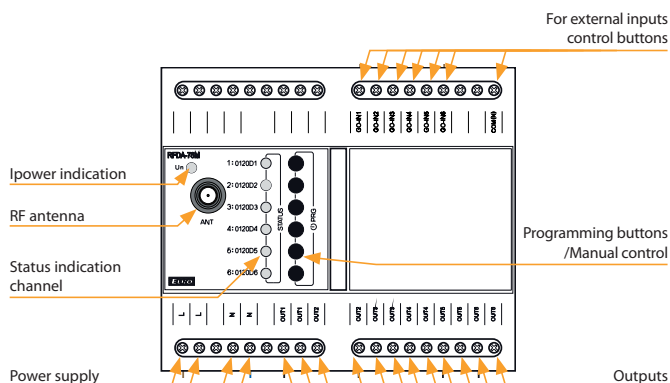

**Connection**

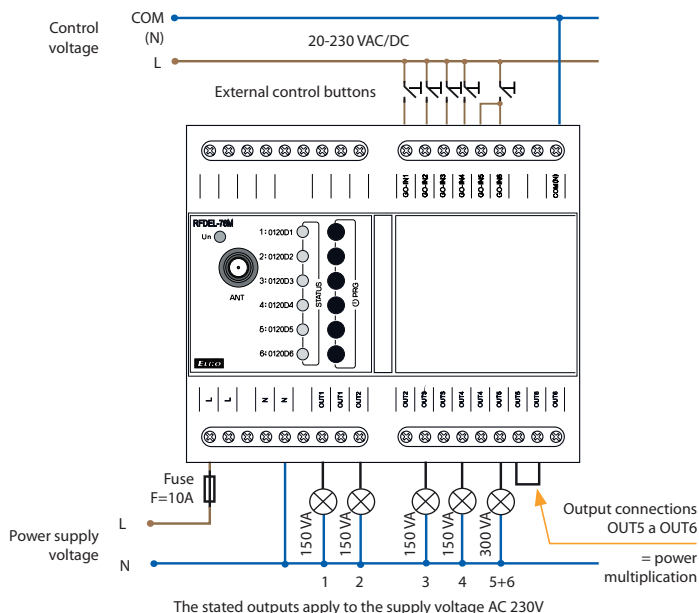

**Types of connectable loads**

R resistive	L inductive	C capacitive	LED light	ESL saving





**USS**

Designed for switching, control and signalling of auxiliary and power circuits.



**USS | Controlling and signalling modules**

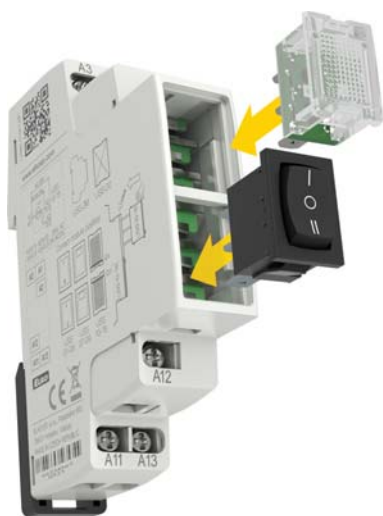

- Independent switch units designed for flexible controlling and switching of power circuits.
- USS - "Do It Yourself" = it is possible to "click into" different types of switches and signalling units into the basic module.
- Units are delivered as components and configured by the user.
- 16 types of units: switches, push buttons, signal lights of different colours including flashing lights units are replaceable also for future (for example when an application is changed, extended, etc...).
- Units are also replaceable in the future (for example when an application is changed, extended, etc...).
- It is possible to place up to two units into one MODULE (for example 2x switch, 2x signalling lights or combinations) = saves space in switch-board panels.
- 1-MODULE (90 x 17.6 x 64 mm/3.5" x 0.7" x 2.5"), DIN rail mounting.
- Operating temperature -20 °C to +55 °C (-4 °F to 131 °F).
- M3 screw with clamp terminals.

**Connection**

**Connection of signalling light**

**Installing the USS into the module**

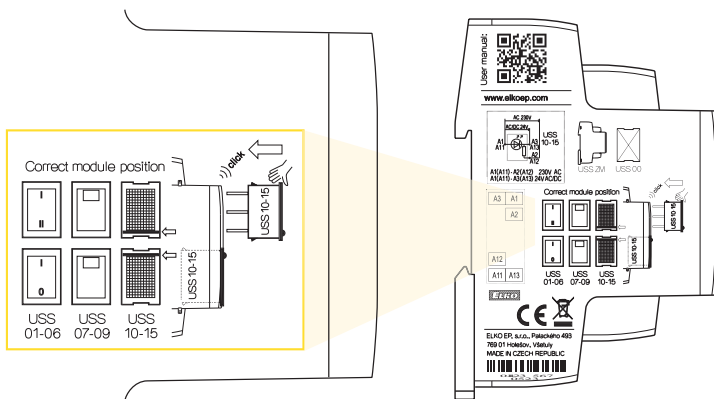
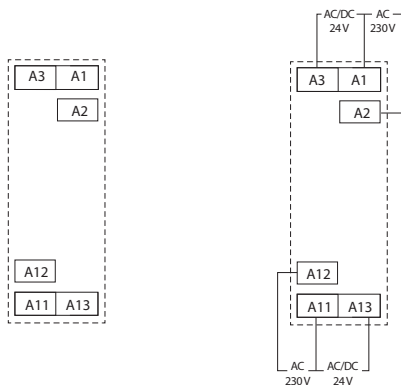

**Examples of mounting**



USS-01 + USS-03

USS-07 + USS-11

USS-11 + USS-01

USS-10 + USS-00

USS-10 + USS-11

USS-07 + USS-00

TYPE DESIGNATION	EAN CODE	CONNECTION	RATED CURRENT/VOLTAGE (FOR SWITCHES) SUPPLY VOLTAGE (FOR SIGNALLING LIGHTS)	DIMENSIONS	DESCRIPTION
USS-ZM	8595188124577	MODULE	-	19 x 17.6 x 64 mm (0.75" x 0.69" x 2.5")	Basic MODULE (housing with terminals and contacts)
USS-00	8595188124614	BLIND FLANGE	-	21 x 15 x 7 mm (0.83" x 0.59" x 0.28")	Used to fill in an empty position in the front panel
<b>Switches, push buttons</b>					
USS-01	8595188124621		6A/250 V AC	21 x 15 x 20 mm (0.83" x 0.59" x 0.79")	Switch
USS-02	8595188124638		10 A/250 V AC	21 x 15 x 20 mm (0.83" x 0.59" x 0.79")	Alternation switch
USS-03	8595188124645		10 A/250 V AC	21 x 15 x 20 mm (0.83" x 0.59" x 0.79")	Switch with central position
USS-04	8595188124652		6 A/250 V AC	21 x 15 x 20 mm (0.83" x 0.59" x 0.79")	Switch + push with central position
USS-05	8595188124669		6 A/250 V AC	21 x 15 x 20 mm (0.83" x 0.59" x 0.79")	Push button with central position
USS-06/S	8595188124676		10 A/250 V AC	21 x 15 x 20 mm (0.83" x 0.59" x 0.79")	Push button NO
USS-06/R	8595188136372		10 A/250 V AC	21 x 15 x 20 mm (0.83" x 0.59" x 0.79")	Push button NC
<b>Switches with glow lamp</b>					
USS-07	8595188124683		6 A/250 V AC	21 x 15 x 20 mm (0.83" x 0.59" x 0.79")	Switch with glow lamp (red)
USS-08	8595188124690		6 A/250 V AC	21 x 15 x 20 mm (0.83" x 0.59" x 0.79")	Switch with glow lamp (green)
USS-09	8595188124706		6 A/250 V AC	21 x 15 x 20 mm (0.83" x 0.59" x 0.79")	Switch with glow lamp (yellow)
<b>Signalling light</b>					
USS-10	8595188124331		A1-A2, AC 230 V A1-A3, AC/DC 24 V	21 x 15 x 14 mm (0.83" x 0.59" x 0.55")	Signalling LED (red)
USS-11	8595188124348		A1-A2, AC 230 V A1-A3, AC/DC 24 V	21 x 15 x 14 mm (0.83" x 0.59" x 0.55")	Signalling LED (green)
USS-12	8595188124355		A1-A2, AC 230 V A1-A3, AC/DC 24 V	21 x 15 x 14 mm (0.83" x 0.59" x 0.55")	Signalling LED (yellow)
USS-13	8595188124362		A1-A2, AC 230 V A1-A3, AC/DC 24 V	21 x 15 x 14 mm (0.83" x 0.59" x 0.55")	Signalling LED (white)
USS-14	8595188124898		A1-A2, AC 230 V A1-A3, AC/DC 24 V	21 x 15 x 14 mm (0.83" x 0.59" x 0.55")	Signalling LED <b>FLASHING</b> (red)
USS-15	8595188124379		A1-A2, AC 230 V A1-A3, AC/DC 24 V	21 x 15 x 14 mm (0.83" x 0.59" x 0.55")	Signalling LED (blue)

## 1-phase

## AC

**HRN-33**

Supply and monitored voltage in range AC 48-276 V, 1x output for U<sub>max</sub> and U<sub>min</sub> adjustable level. page 90

**HRN-35**

As HRN-33 but individual output for each level (U<sub>max</sub>/U<sub>min</sub>). Adjustable time delay to eliminate voltage peaks. page 90

**HRN-37**

As HRN-33, but in voltage range AC 24-150 V. page 90

**HRN-63**

Supply and monitored voltage in range AC 48-276 V, 1x output for U<sub>max</sub> and U<sub>min</sub> adjustable level. page 90

**HRN-67**

as HRN-63, but in voltage range AC 24-150 V. page 90

## DC

**HRN-34**

as HRN-33 but in voltage range DC 6-30 V for monitoring battery circuits (6, 12, 24 V). page 90

**HRN-64**

as HRN-63 but in voltage range DC 6-30 V for monitoring battery circuits (6, 12, 24 V). page 90

## AC/DC

**HRN-41**

(Hysteresis) monitoring DC and AC voltage 10-500 V, divided into 3 inputs and 3 ranges, 2 independent outputs 16 A, 2x time delay. page 92

**HRN-42**

(Window) as HRN-41 but function WINDOW. Other functions (applicable for HRN-41): faulty state memory, hysteresis, galv. separated supply. page 92

## 3-phase

**HRN-55**

Supply from all phases. page 94

**HRN-55N**

Supply L1-N (monitors also disconnection of neutral wire). Time delay to eliminate peaks. page 94

**HRN-57**

Supply from all phases. page 95

**HRN-57N**

Supply L1-N (monitors also neutral wire disconnection). Adjustable voltage level. page 95

**HRN-54**

Supply from all phases. page 96

**HRN-54N**

Supply L1-N (monitors also disconnection of neutral wire). All parameters adjustable by potentiometers. page 96

**HRN-56/208**

Adjustable level U<sub>min</sub>. page 97

**HRN-56/240**

Adjustable level U<sub>min</sub>. page 97

**HRN-56/400**

Adjustable level U<sub>min</sub>. page 97

**HRN-56/480**

Adjustable level U<sub>min</sub>. page 97

**HRN-56/575**

Adjustable level U<sub>min</sub>. page 97

**HRN-43**

Galvanically separated supply AC 230 V, AC 400 or AC/DC 24 V, memory, adjustable hysteresis and delay, 2 x independent output. page 98

**HRN-43N**

Galvanically separated supply AC 230 V, AC 400 or AC/DC 24 V, memory, adjustable hysteresis and delay, 2 x independent output. page 98

**HRN-100**

Possibility of 3/4-wire connection, allows monitoring lower and upper level voltage and frequency, Optional also monitors outages, order, phase asymmetry incl. failure of neutral page 100

## Optical signaling

**MPS-1**

Optical signaling of 3-phase network. page 103

## Power factor

**COS-2**

monitors and scores power factor (phase shift between current and voltage cos φ) in 3-phase/1-phase circuits (motors, pumps etc.). page 104

## Frequency

**HRF-10**

for monitoring the frequency of AC voltage. The monitored frequency 50/60/400 Hz is selected by a switch. page 106



Type	Design	Voltage	Secure variables							Setting			Description	Page
			Phases	Range	$\wedge U$	$\vee U$	Failure	Phase sequence	Asymmetry	Delay	Hysteresis	Memory Errors		
HRN-41/230 V HRN-41/400 V HRN-41/24 V	3-M	AC 230 V AC 400 V AC/DC 24 V	1	AC/DC 50 V AC/DC 160 V AC/DC 500 V	●	●	x	x	x	●	●	●	Second relay function (independent/parallel). Galvanically separated power supply from measuring inputs.	92
HRN-42/230 V HRN-42/24 V	3-M	AC 230 V AC/DC 24 V	1	AC/DC 50 V AC/DC 160 V AC/DC 500 V	●	●	x	x	x	●	●	●		
HRN-33	1-M	from monitored	1	AC 48 - 276 V	●	●	x	x	x	●	x	x	For all types, the delay is adjustable from 0 - 10 seconds (to eliminate short-term outages or peaks). The lower voltage level (Umin) is set in % of the upper level (Umax).	90
HRN-34	1-M	from monitored	1	DC 6 - 30 V	●	●	x	x	x	●	x	x		
HRN-35	1-M	from monitored	1	AC 48 - 276 V	●	●	x	x	x	●	x	x		
HRN-37	1-M	from monitored	1	AC 24 - 150 V	●	●	x	x	x	●	x	x		
HRN-63	1-M	from monitored	1	AC 48 - 276 V	●	●	x	x	x	●	x	x		
HRN-64	1-M	from monitored	1	DC 6 - 30 V	●	●	x	x	x	●	x	x		
HRN-67	1-M	from monitored	1	AC 24 - 150 V	●	●	x	x	x	●	x	x		
HRN-54	1-M	from monitored	3	AC 3 x 300 - 500 V	●	●	●	●	x	●	x	x	Power supply from all phases, i.e. the relay function is preserved even if one phase fails.	96
HRN-54N	1-M	from monitored	3	AC 3 x 172 - 287 V	●	●	●	●	x	●	x	x	Power supply L1-N, i.e. the relay also monitors the neutral wire interruption.	94
HRN-55	1-M	from monitored	3	AC 3 x 300 - 500 V	x	x	●	●	x	●	x	x	Power supply from all phases, i.e. the relay function is preserved even if one phase fails.	
HRN-55N	1-M	from monitored	3	AC 3 x 172 - 287 V	x	x	●	●	x	●	x	x	Power supply L1-N, i.e. the relay also monitors the neutral wire interruption.	95
HRN-57	1-M	from monitored	3	AC 3 x 300 - 500 V	●	●	●	x	x	●	x	x	Power supply from all phases, i.e. the relay function is preserved even if one phase fails.	
HRN-57N	1-M	from monitored	3	AC 3 x 172 - 287 V	●	●	●	x	x	●	x	x	Power supply L1-N, i.e. the relay also monitors the neutral wire interruption, replacement for HRN-52.	
HRN-56/208 HRN-56/240 HRN-56/400	1-M	from monitored	3	AC 3 x 125 - 276 V AC 3 x 144 - 276 V AC 3 x 240 - 460 V	x	●	●	●	x	●	x	x	Thanks to the power supply from all three phases, the relay is operational even if one phase fails.	97
HRN-56/480 HRN-56/575	3-M	from monitored	3	AC 3 x 228 - 550 V AC 3 x 345 - 660 V	x	●	●	●	x	●	x	x		
HRN-43/230 V HRN-43/400 V HRN-43/24 V	3-M	AC 230 V AC 400 V AC/DC 24 V	3	AC 3 x 84 - 480 V	●	●	●	●	●	●	●	●	2 output relays, functions of the second relay may be selected (independent/parallel). Galvanically separated power supply.	98
HRN-43N/230 V HRN-43N/400 V HRN-43N/24 V	3-M	AC 230 V AC 400 V AC/DC 24 V	3	AC 3 x 48 - 276 V	●	●	●	●	●	●	●	●		
HRN-100	2-M	from monitored	3	$U_{LN} = 3 \sim 155 - 500 V$ $U_{LL} = 3 \sim 90 - 288 V$	●	●	●	●	●	●	●	●	Optional 3-wire or 4-wire connection (with or without zero) allows the monitoring of the upper and lower level of voltage and frequency, further failure, sequence or asymmetry of phases incl. neutral break both output contacts can be configured individually	100

Signal relays

MPS-1	1-M	from monitored	3	AC 3 x 50 - 253 V	x	●	●	●	x	x	x	x	Optical signaling of three-phase network.	103
-------	-----	----------------	---	-------------------	---	---	---	---	---	---	---	---	---	-----

Relay for frequency (f) monitoring

Type	Design	Supply voltage	Secure variables				Setting				Description	Page	
			Phases	Frequency Range	Frequency $\wedge$	Frequency $\vee$	Delay	Hysteresis	Frequency $\wedge$	Frequency $\vee$			
HRF-10	3-M	AC 161 - 500 V	1	40 - 60 Hz 48 - 72 Hz 320 - 480 Hz	●	●	●	●	●	●	●	Switchable ranges of rated frequency .	106

Relay for power factor (cos-φ) monitoring

Type	Design	Supply voltage	Secure variables				Setting			Description	Page	
			Phases	cos φ range	$\wedge \cos \phi$	$\vee \cos \phi$	Delay	Hysteresis	Memory Errors			
COS-2/230 V COS-2/110 V COS-2/400 V COS-2/24 V	3-M	AC 230 V AC 110 V AC 400 V AC/DC 24 V	3	0.1 - 0.99	●	●	●	●	●	●	Two output relays, one independent relay for each level Galvanically separated power supply.	104



EAN code  
 HRN-33: 8595188115636  
 HRN-34: 8595188115643  
 HRN-35: 8595188115650  
 HRN-37: 8595188130615  
 HRN-63: 8595188130622  
 HRN-64: 8595188130639  
 HRN-67: 8595188130646

Technical parameters	HRN-33/ HRN-63	HRN-34/ HRN-64	HRN-35	HRN-37/ HRN-67
<b>Supply and measuring</b>				
Terminals:	A1 - A2	A1 - A2	A1 - A2	A1 - A2
Voltage range:	AC 48 - 276 V (50/60 Hz)	DC 6 - 30 V	AC 48 - 276 V (50/60 Hz)	AC 24-150 V (50/60 Hz)
Burden:	HRN-33 max. 26 VA	-	max. 45 VA	HRN-37 max. 8 VA
	HRN-63 max. 45 VA	-		HRN-67 max. 30 VA
	max. 2 W	max. 0.5 W	max. 2 W	max. 2 W
Max. dissipated power (Un + terminals):	4 W	4 W	6 W	4 W
Upper level (Umax):	AC 160 - 276 V	DC 18 - 30 V	AC 160 - 276 V	AC 80-150 V
Bottom level (Umin):	30-95 % Umax	35 - 95 % Umax	30 - 95 % Umax	30-95 % Umax
Max. permanent overload:	AC 276 V	DC 36 V	AC 276 V	AC 276 V
Peak overload <1ms:	AC 290 V	DC 50 V	AC 290 V	AC 290 V
Time delay	adjustable 0 - 10 s			
<b>Accuracy</b>				
Setting accuracy (mechanical):	5 %			
Repeat accuracy:	<1 %			
Dependence on temperature:	< 0.1 %/°C (°F)			
Tolerance of limit values:	5 %			
Hysteresis (from fault to normal):	2 - 6 % of adjusted value (only HRN-33, HRN-34, HRN-35, HRN-37)			
<b>Output</b>				
1x changeover				
Number of contacts:	SPDT (AgNi/ Silver Alloy)	SPDT (AgNi/ Silver Alloy)	for each level of voltage, (AgNi)	SPDT (AgNi/ Silver Alloy)
Current rating:	16 A/AC1			
Breaking capacity:	4000 VA/AC1, 384 W/DC			
Inrush current:	30 A/< 3 s			
Switching voltage:	250 V AC/24 V DC			
Output indication:	red/green LED			
Mechanical life:	30.000.000 operations			
Electrical life (AC1):	70.000 operations			
<b>Other information</b>				
Operating temperature:	-20 °C to 55 °C (-4 °F to 131 °F)			
Storage temperature:	-30 °C to 70 °C (-22 °F to 158 °F)			
Dielectrical strength:	4 kV (supply - output)			
Operating position:	any			
Mounting:	DIN rail EN 60715			
Protection degree:	IP40 from front panel, IP20 terminals			
Overvoltage category:	III.			
Pollution degree:	2			
Max. cable size (mm²):	solid wire max. 1x 2.5 or 2x 1.5, with sleeve max. 1x 2.5 (AWG 12)			
Dimensions:	90 x 17.6 x 64 mm (3.5" x 0.7" x 2.5")			
Weight:	62 g (2.2 oz.)	75 g (2.6 oz.)	86 g (3 oz.)	61 g (2.2 oz.)
Standards:	EN 60255-1, EN 60255-26, EN 60255-27			

- It serves to control supply voltage for appliances sensitive to supply tolerance, protection of the device against under/over voltage.
- HRN-3x is band voltage relay, HRN-6x is over/under voltage relay. For difference - see graph of function.
- **HRN-33, HRN-63**
  - Monitors voltage in range AC 48 - 276 V.
  - Umax and Umin can be monitored independently.
- **HRN-34, HRN-64**
  - Like HRN-33, but voltage range is DC 6 - 30 V,
  - Monitoring of battery circuits (24 V).
- **HRN-35**
  - Like HRN-33, but independent output relays for each voltage level,
  - Switching of other loads possible.
- **HRN-37, HRN-67**
  - Like HRN-33, monitors voltage in range AC 24 - 150 V,
  - It is possible to monitor level of overvoltage and undervoltage independently.
- Voltage Umin adjusted as % of Umax.
- 3-state indication - LEDs indicating normal state and 2 fault states.

**Description**

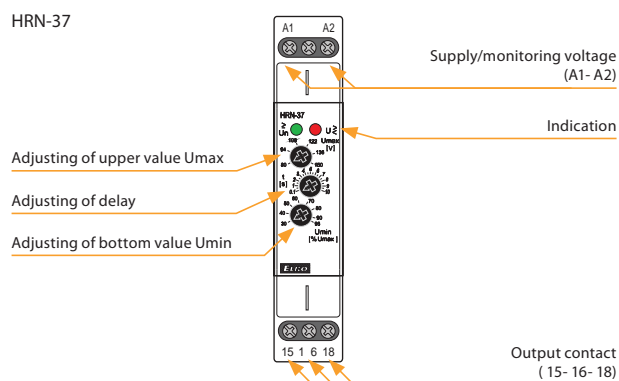
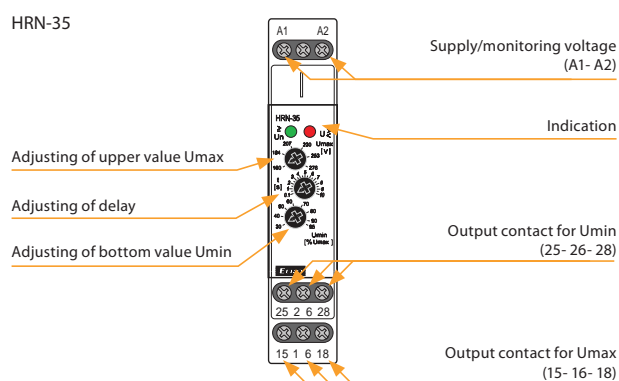

**Connection**

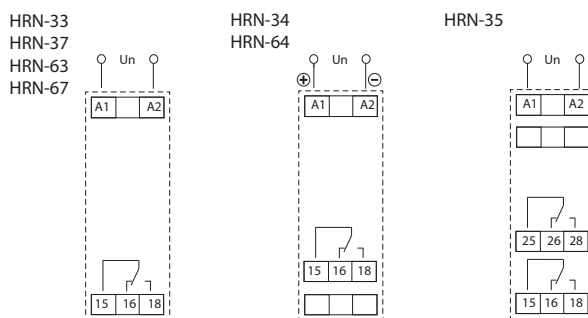

Function HRN-33, 34, 35, 37 (band voltage relay)

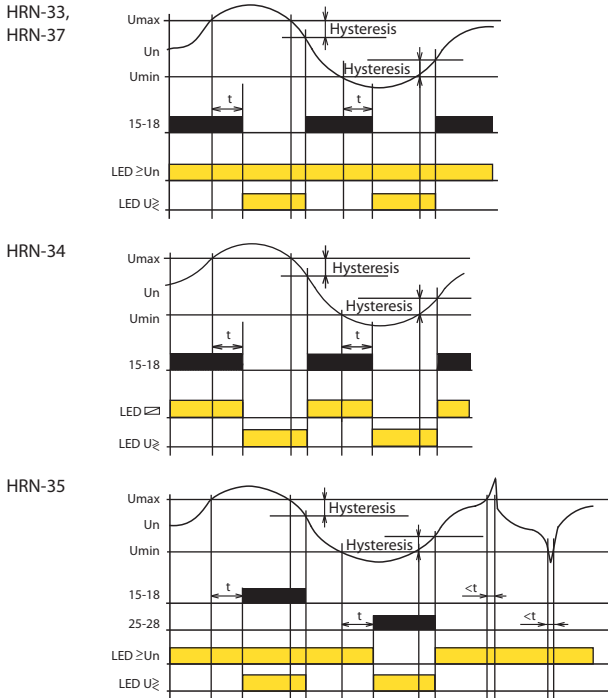

Monitoring relay series HRN-3x monitors level of voltage in single - phase circuits. Monitored voltage serves also as supply voltage. It is possible to set two independent (all occurrences) levels of voltage, when exceeded the output is activated. HRN-33 and HRN-34 - in normal state the output relay is permanently switched. It switches off when there is a limit settings. This combination of linkage of the output relay is advantageous when the full failure of supply (monitored) voltage is considered to be a faulty state in the same way as a decrease of voltage within the set level. Output relay is in both situations always switched off. Differently HRN-35 version uses independent relay for each level, in normal state it is switched off. If the upper level is exceeded (for example overvoltage) 1 relay switches on, when the bottom level (e.g. undervoltage) is exceeded 2 relay switches. It is thus possible to see the particular faulty state. To eliminate short peaks in the main the time delay, which is possible to be set in range 0 - 10 s, is used. It functions when changing from normal to faulty state and prevents unavailing pulsation of the output relay caused by parasitive peaks. Time delay doesn't apply when changing from faulty to normal state, but hysteresis (1 - 6 % depends on the voltage setting) apply. Thanks to changeover contacts it is possible to get other configurations and functions according to actual requirements of the application.

Function HRN-63, 64, 67 (over/under voltage relay)

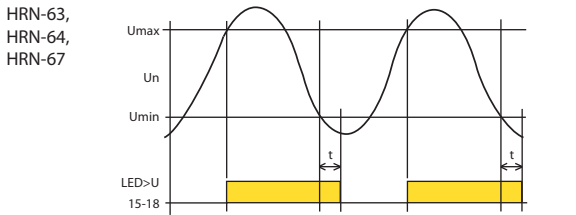

Monitoring relay line HRN-6x serves to monitor levels of voltage in single-phase or DC circuits. Monitored voltage is in the same time also supply voltage. It is possible to set two independent levels of voltage. When Umax is exceeded, output is activated. In case voltage level falls below Umin, output is deactivated. This combination is advantageous when full absence of supply voltage is understood as faulty state, as well as voltage drop within the set level. To eliminate short voltage peaks in the main there is time delay which can be set in a range of 0 - 10 sec. Such delay applies in case of going from overvoltage to undervoltage. In case of returning from undervoltage to overvoltage this delay doesn't apply. Thanks to changeover output contacts it is possible to reach various configurations and functions according to requirements or an application.

**Legend:**  
 Umax - upper adjustable level of voltage  
 Un - measured voltage  
 Umin - bottom adjustable level of voltage  
 15-18 - switching contact of output relay No.1  
 25-28 - switching contact of output relay No. 2  
 LED ≥ Un - green indicator light  
 LED U ≥ - red indicator light  
 LED U > - red indicator light

Symbol

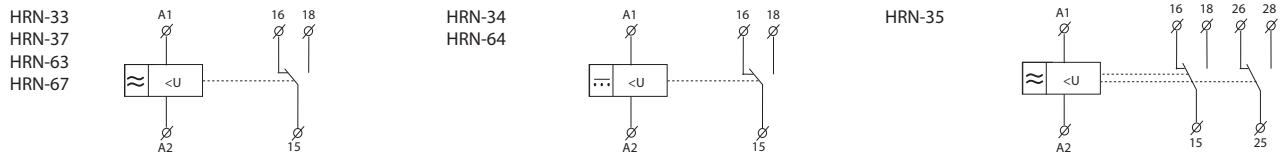

Indication LED

<p>HRN-33, HRN-37</p> <p><b>Normal state</b>                  Umin &lt; Un &lt; Umax                  Green LED = ON                  Red LED = OFF</p>	<p>HRN-34</p> <p><b>Normal state</b>                  Umin &lt; Un &lt; Umax                  Green LED = ON                  Red LED = OFF</p>	<p>HRN-63, HRN-67</p> <p><b>Exceeded Umax (overvoltage)</b>                  Un &gt; Umax                  Green LED = ON                  Red LED = ON</p>	<p>HRN-64</p> <p><b>Exceeded Umax (overvoltage)</b>                  Un &gt; Umax                  Green LED = OFF                  Red LED = ON</p>
<p><b>Exceeded Umax (overvoltage) Drop below Umin (undervoltage)</b>                  Un &gt; Umax or Un &lt; Umin                  Green LED = ON                  Red LED = ON</p>	<p><b>Exceeded Umax (overvoltage) Drop below Umin (undervoltage)</b>                  Un &gt; Umax or Un &lt; Umin                  Green LED = OFF                  Red LED = ON</p>	<p><b>Drop below Umin (undervoltage)</b>                  Un &lt; Umin                  Green LED = ON                  Red LED = OFF</p>	<p><b>Drop below Umin (undervoltage)</b>                  Un &lt; Umin                  Green LED = ON                  Red LED = OFF</p>
<p>HRN-35</p> <p><b>Normal state</b>                  Umin &lt; Un &lt; Umax                  Green LED = ON                  Red LED = OFF</p>	<p><b>Exceeded Umax (overvoltage)</b>                  Un &gt; Umax                  Green LED = ON                  Red LED = ON</p>	<p><b>Drop below Umin (undervoltage)</b>                  Un &lt; Umin                  Green LED = OFF                  Red LED = ON</p>	



EAN code  
 HRN-41/230V: 8595188140409  
 HRN-41/400V: 8595188140423  
 HRN-41/24V: 8595188140416  
 HRN-42/230V: 8595188140447  
 HRN-42/24V: 8595188140454

Technical parameters	HRN-41	HRN-42	
<b>Supply</b>			
Supply terminals:	A1 - A2		
Voltage range:	AC 230 V, AC 400 V or AC/DC 24 V (AC 50/60 Hz)		
Burden max.:	5 VA/2.5 W (AC 230 V, AC 400 V), 2 VA/2.5 W (AC/DC 24 V)		
Max. dissipated power (Un + terminals):	7 W (230 V, 400 V), 6 W (24 V)		
Supply voltage tolerance:	-15 %; +10 %		
<b>Measuring</b>			
Ranges*:	AC/DC 10 - 50 V (AC 50/60 Hz)	AC/DC 32 - 160 V (AC 50/60 Hz)	AC/DC 100 - 500 V (AC 50/60 Hz)
Terminals:	C - B1	C - B2	C - B3
Input resistance:	212 kΩ	676 kΩ	2.12 MΩ
Max. permanent overload:	100 V	300 V	600 V
Peak overload <1ms:	250 V	700 V	1 kV
Time delay for Umax:	adjustable 0.1 - 10 s		
Time delay for Umin:	adjustable 0.1 - 10 s		
<b>Accuracy</b>			
Setting accuracy (mechanical):	5 %		
Repeat accuracy:	<1 %		
Dependence on temperature:	< 0.1 %/°C (°F)		
Tolerance of limit values:	5 %		
Hysteresis (from fault to normal):	selectable 5 %/10 % from range		
<b>Output</b>			
Number of contacts:	2x changeover/SPDT (AgNi/Silver Alloy)		
Current rating:	16 A/AC1		
Breaking capacity:	4000 VA/AC1, 384 W/DC		
Inrush current:	30 A/< 3 s		
Switching voltage:	250 V AC/24 V DC		
Output indication:	yellow LED		
Mechanical life:	30.000.000 operations		
Electrical life (AC1):	70.000 operations		
<b>Other information</b>	-20 °C to +55 °C (-4 °F to 131 °F)		
Operating temperature:	-30 °C to +70 °C (-22 °F to 158 °F)		
Storage temperature:	4 kV (supply - output)		
Dielectrical strength:	any		
Operating position:	DIN rail EN 60715		
Mounting:	IP40 from front panel/IP20 terminals		
Protection degree:	III.		
Overvoltage category:	2		
Pollution degree:	solid wire max. 1x 2.5 or 2x 1.5/ with sleeve max. 1x 1.5 (AWG 12)		
Max. cable size (mm <sup>2</sup> ):	90 x 52 x 65 mm (3.5" x 2" x 2.6")		
Dimensions:	249 g (110 V, 230 V, 400 V) (8.8 oz.), 146 g (24 V) (5.1 oz.)		
Weight:	EN 60255-1, EN 60255-26, EN 60255-27		
Standards:			

\* Only one of the inputs can be connected.

- Relay designed for monitoring DC and AC voltage in three ranges.
- The relay controls the size of the voltage in two independent levels (Umin, Umax).
- Setting the monitored level Umax (in % of range).
- Setting the monitored level Umin (in % of range - for HRN-42 - function WINDOW, (in % of the set upper limit - for HRN-41 - function HYSTERESIS).
- Function of second relay (independently/in parallel).
- Adjustable delay for eliminating short-term outages and surges for every level independently.
- Galvanically separated power supply from monitoring inputs.
- Output contact for each monitored voltage level.

## Description

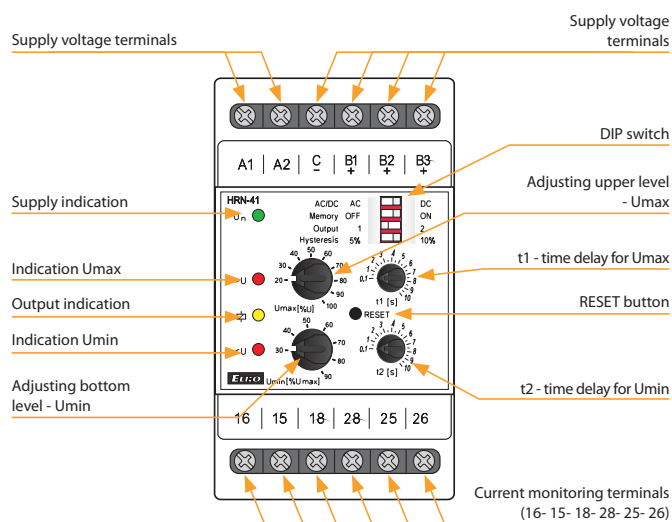

## Description and importance of DIP switches

AC/DC AC	<input type="checkbox"/>	DC	Measured AC/DC voltage
Memory OFF	<input type="checkbox"/>	ON	MEMORY function
Output 1	<input type="checkbox"/>	2	Relay function setting
Hysteresis 5%	<input type="checkbox"/>	10%	Hysteresis setting

## Connection

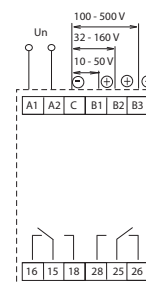

## Symbol

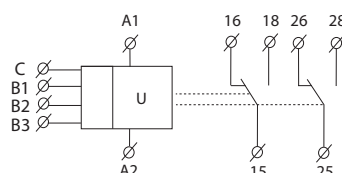

Function

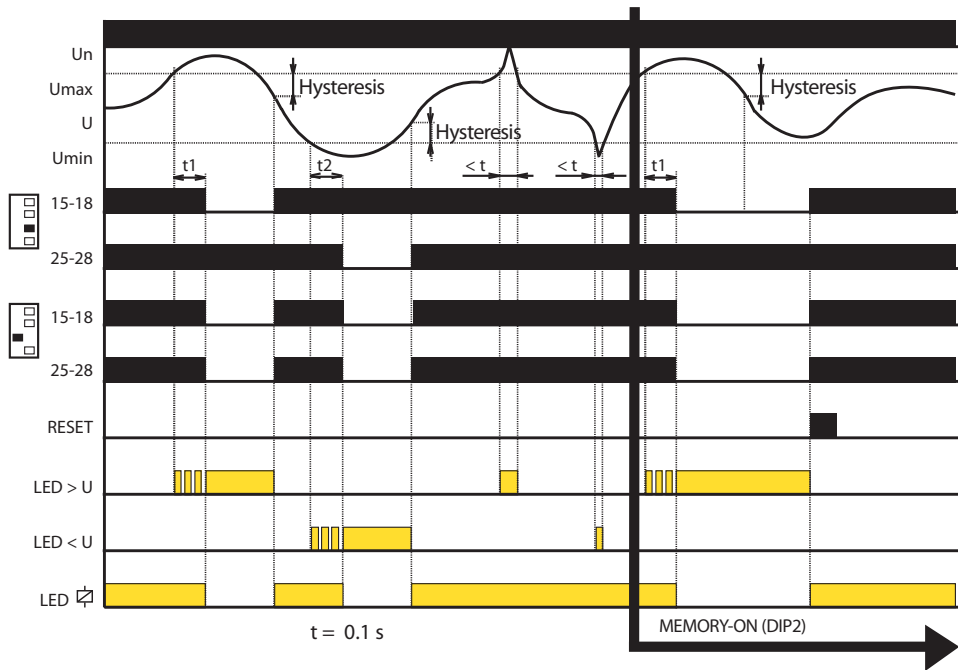

- If the value of the monitored voltage is in the zone between the set upper and lower levels, the status OK occurs - both relays are closed and the yellow LED illuminates. If the value of the monitored voltage is outside the set limits ( $> U_{max}$  or  $< U_{min}$ ), an error state occurs.
- When moving to an error state  $U > U_{max}$ , it times the delay  $t_1$  and a red  $LED > U$  simultaneously flashes. After the  $t_1$  time elapses, the red  $LED > U$  illuminates and the relevant relay opens.
- When moving to an error state  $U < U_{min}$ , it times the delay  $t_2$  and a red  $LED < U$  simultaneously flashes. After the time  $t_2$  elapses, the red  $LED < U$  illuminates and the relevant relay opens.
- When moving from the error status to the OK status, the relevant red LED immediately goes out, and the corresponding relay closes.



EAN code  
 HRN-55: 8595188137225  
 HRN-55N: 8595188137232

Technical parameters	HRN-55	HRN-55N
Monitoring terminals:	L1, L2, L3	L1, L2, L3, N
Supply terminals:	L1, L2, L3	L1, L2, L3, N
Voltage:	3x 400 V (50/60 Hz)	3x 400 V/230 V (50/60 Hz)
Burden:	max. 2 VA/1 W	
Max. dissipated power (Un + terminals):	1 W	
Level Umax:	125 % Un	
Level Umin:	75 % Un	
Hysteresis:	2 %	
Max. permanent:	AC 3x 460 V	AC 3x 265 V
Peak overload <1ms:	AC 3x 500 V	AC 3x 288 V
Time delay T1:	max. 500 ms	
Time delay T2:	adjustable 0.1 - 10 s	
<b>Output</b>		
Number of contacts:	1x changeover/SPDT (AgNi/Silver Alloy)	
Current rating:	8 A/AC1	
Breaking capacity:	2000 VA/AC1, 240 W/DC	
Inrush current:	10 A	
Switching voltage:	250 V AC/24 V DC	
Output indication:	red LED	
Mechanical life:	10.000.000 operations	
Electrical life (AC1):	100.000 operations	
<b>Other information</b>		
Operating temperature:	-20 °C to 55 °C (-4 °F to 131 °F)	
Storage temperature:	-30 °C to 70 °C (-22 °F to 158 °F)	
Electrical strength:	4 kV (supply - output)	
Operating position:	any	
Mounting:	DIN rail EN 60715	
Protection degree:	IP40 from front panel/IP10 terminals	
Overvoltage category:	III.	
Pollution degree:	2	
Max. cable size (mm <sup>2</sup> ):	solid wire max. 2x 2.5 or 1x 4 with sleeve max. 1x 2.5 or 2x 1.5 (AWG 12)	
Dimensions:	90 x 17.6 x 64 mm (3.5" x 0.7" x 2.5")	
Weight:	61 g (2.15 oz.)	63 g (2.22 oz.)
Standards:	EN 60255-1, EN 60255-26, EN 60255-27	

- Relay monitors phase sequence and failure, exceeding of monitored voltage in 3-phase main.
- **HRN-55:** supply from all phases, which means that function of relay is applicable also if 1-phase fails.
- **HRN-55N:** supply L1, L2, L3-N, it means that relay also monitors break of neutral point.
- Fixed delay T1 (500 ms) and adjustable delay T2 (0.1 - 10 s).

**Description**

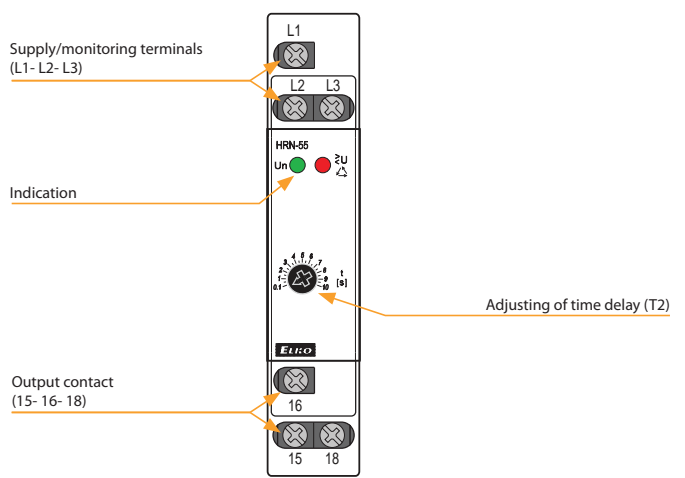

**Function**

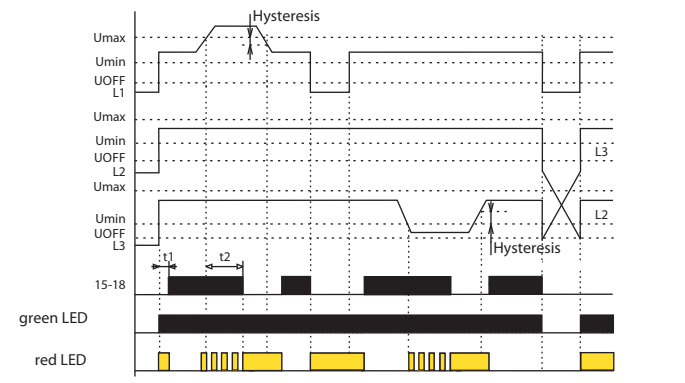

**Connection Symbol**

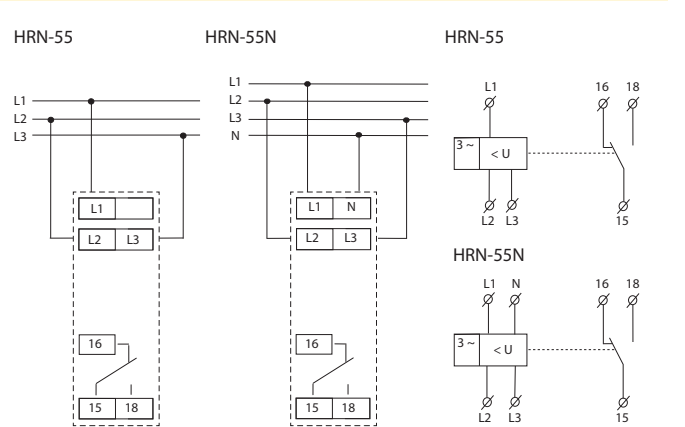

**Function description**

Relay in 3-phase main monitors correct phase sequence and failure of any phase. Green LED is permanently ON and indicates presence of power supply voltage. In case of phase failure or exceeding voltage level red LED flashes and relay breaks. When changing to faulty state, time delay applies. Time delay setting is set by a potentiometer on front panel of the device. In case of incorrect phase sequence red LED shines permanently and relay is open. In case supply voltage falls below 60 % Un (OFF lower level) relay immediately opens with no delay and faulty state is indicated by red LED.

**HRN-55** - thanks to supply all phases, this relay is able to stay operational also if one phase is out.

**HRN-55N** -supply L1, L2, L3-N, means that relay monitor also failure in neutral wire.



EAN code  
 HRN-57: 8595188137256  
 HRN-57N: 8595188137249

Technical parameters	HRN-57	HRN-57N
Monitoring terminals:	L1, L2, L3	L1, L2, L3, N
Supply terminals:	L1, L2, L3	L1, L2, L3, N
Voltage:	3x 400 V (50-60 Hz)	3x 400 V/230 V (50-60 Hz)
Burden:	max. 2 VA/1 W	
Max. dissipated power (Un + terminals):	2 W	
Level Umax:	105 - 125 % Un	
Level Umin:	75 - 95 % Un	
Hysteresis:	2 %	
Max. permanent overload:	AC 3x 460 V	AC 3x 265 V
Peak overload <1ms:	AC 3x 500 V	AC 3x 288 V
Time delay T1:	max. 500 ms	
Time delay T2:	adjustable 0.1-10 s	
<b>Output</b>		
Number of contacts:	1x changeover/SPDT (AgNi/Silver Alloy)	
Current rating:	8 A/AC1	
Breaking capacity:	2000 VA/AC1, 240 W/DC	
Inrush current:	10 A	
Switching voltage:	250 V AC/24 V DC	
Output indication:	red LED	
Mechanical life:	10.000.000 operations	
Electrical life (AC1):	100.000 operations	
<b>Other information</b>		
Operating temperature:	-20 °C to 55 °C (-4 °F to 131 °F)	
Storage temperature:	-30 °C to 70 °C (-22 °F to 158 °F)	
Electrical strength:	4 kV (supply - output)	
Operating position:	any	
Mounting:	DIN rail EN 60715	
Protection degree:	IP40 from front panel/IP10 terminals	
Overvoltage category:	III.	
Pollution degree:	2	
Max. cable size (mm <sup>2</sup> ):	solid wire max. 2x 2.5 or 1x 4/ with sleeve max. 1x 2.5 or 2x 1.5 (AWG 12)	
Dimensions:	90 x 17.6 x 64 mm (3.5" x 0.7" x 2.5")	
Weight:	62 g (2.19 oz.)	63 g (2.22 oz.)
Standards:	EN 60255-1, EN 60255-26, EN 60255-27	

- It serves to monitor voltage in a switchboard, protection of devices in 3-phase main.
- It monitors value of voltage in 3-phase main.
- It is possible to set upper and lower level independently.
- Adjustable time delay eliminated short voltage peaks and failures in the main.
- Relay doesn't monitor phase sequence.
- **HRN-57:** supply from all phases, means that relay is functional also in case of failure in one phase.
- **HRN-57N:** supply L1, L2, L3-N, means that relay monitors also failure of neutral wire.

**Description**

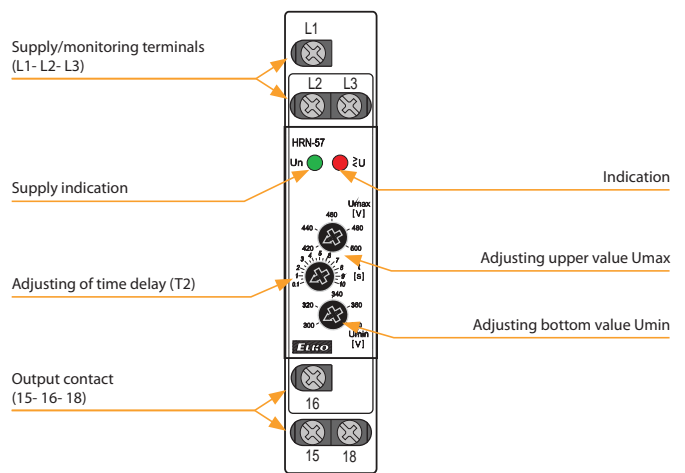

**Function**

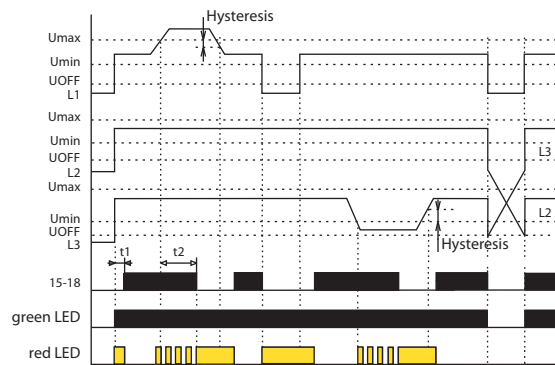

**Connection**

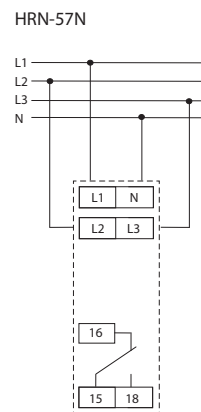
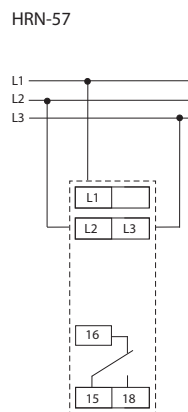

**Symbol**

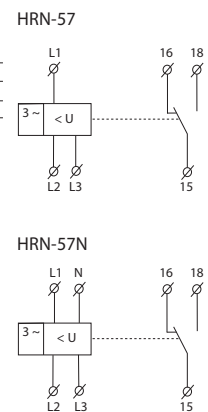

**Function description**

Relay in 3-phase main monitors size of phase voltage. It is possible to set two independent voltage levels and thus it is possible to set two independent voltage levels and monitor e.g. undervoltage and overvoltage independently. In normal state when voltage is within set levels, output relay is closed and red LED shines. In case supply voltage falls below 60 % Un (U<sub>OFF</sub> lower level) relay immediately breaks without delay and faulty state is indicated by red LED. In case voltage exceeds or falls below the set levels, output relay breaks and red LED shines (LED indicates faulty state - flashes when timing). In case timing is in progress and faulty state is indicated, timing is immediately stopped.



EAN code  
HRN-54: 8595188137201  
HRN-54N: 8595188137218

Technical parameters	HRN-54	HRN-54N
Supply and measuring:	L1, L2, L3	L1, L2, L3, N
Supply terminals:	L1, L2, L3	L1, L2, L3, N
Supply/measured voltage:	3x 400 V (50/60 Hz)	3x 400 V/230 V (50/60 Hz)
Burden:	max. 2 VA/1 W	
Max. dissipated power (Un + terminals):	1 W	
Level Umax:	105 - 125 % Un	
Level Umin:	75 - 95 % Un	
Hysteresis:	2 %	
Max. permanent overload:	AC 3x 460 V	AC 3x 265 V
Peak overload <1ms:	AC 3x 500 V	AC 3x 288 V
Time delay T1:	max. 500 ms	
Time delay T2:	adjustable 0.1-10 s	
<b>Output</b>		
Number of contacts:	1x changeover/SPDT (AgNi/Silver Alloy)	
Current rating:	8 A/AC1	
Breaking capacity:	2000 VA/AC1, 240 W/DC	
Inrush current:	10 A	
Switching voltage:	250 V AC/24 V DC	
Indication of state:	red LED	
Mechanical life:	10.000.000 operations	
Electrical life (AC1):	10.000 operations	
<b>Other information</b>		
Operating temperature:	-20 °C to 55 °C (-4 °F to 131 °F)	
Storage temperature:	-30 °C to 70 °C (-22 °F to 158 °F)	
Electrical strength:	4 kV (supply - output)	
Operating position:	any	
Mounting:	DIN rail EN 60715	
Protection degree:	IP40 from front panel/IP10 terminals	
Overvoltage category:	III.	
Pollution degree:	2	
Max. cable size (mm <sup>2</sup> ):	solid wire max. 2x 2.5 or 1x 4/ with sleeve max. 1x 2.5 or 2x 1.5 (AWG 12)	
Dimensions:	90 x 17.6 x 64 mm (3.5" x 0.7" x 2.5")	
Weight:	62 g (2.19 oz.)	63 g (2.22 oz.)
Standards:	EN 60255-1, EN 60255-26, EN 60255-27	

### Function description

Relay in 3-phase main monitors size of phase voltage. It is possible to set two independent voltage levels and thus it is possible to set two independent voltage levels and monitor e.g. undervoltage and overvoltage independently. In normal state when voltage is within set levels, output relay is closed and red LED shines. In case voltage exceeds or falls below the set levels, output relay opens and red LED shines (LED indicates faulty state - flashes when timing).

In case supply voltage falls below 60 % Un ( $U_{OFF}$  lower level) relay immediately opens without delay and faulty state is indicated by red LED.

In case timing is in progress and faulty state is indicated, timing is immediately stopped.

- It serves to monitor voltage, phase failure and sequence in switchboards, protection of devices in 3-phase mains.
- It is possible to set upper and lower level of monitoring voltage.
- Adjustable time delay eliminates short voltage peaks and failures in the main.
- In case supply voltage falls below 60 % Un ( $U_{OFF}$  lower level) relay immediately opens without delay.
- **HRN-54:** supply from all phases which means that relay is functional also in case when one phase is faulty.
- **HRN-54N:** supply L1, L2, L3-N, means that relay monitors also failure of neutral wire.

### Description

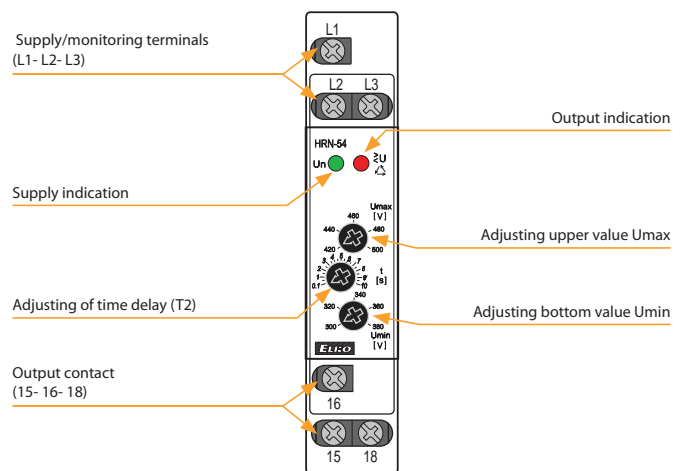

### Function

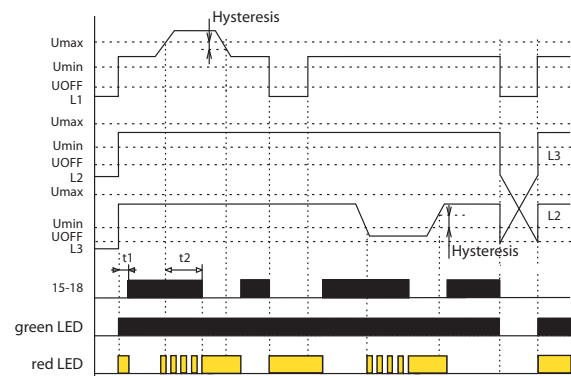

### Connection

HRN-54

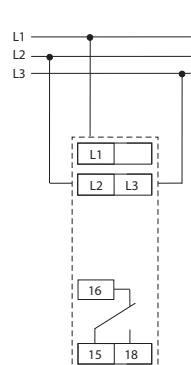

HRN-54N

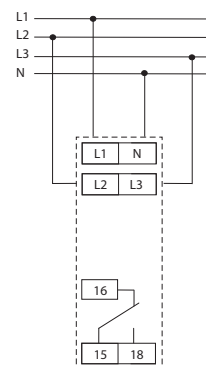

### Symbol

HRN-54

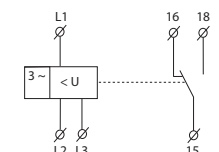

HRN-54N

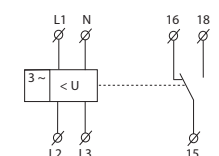





EAN code  
 HRN-56/208V: 8595188130134  
 HRN-56/240V: 8595188137119  
 HRN-56/400V: 8595188137126  
 HRN-56/480V: 8595188130189  
 HRN-56/575V: 8595188130196

- Relay monitors phase sequence and failure (e.g. control of correct motor winding etc.).
- Relay is designated for monitoring of 3-phase networks.
- Supply from all phases which means that relay is functional also in case of one phase failure.
- Supply and monitored supply Un:
 

1-MODULE	3-MODULE
HRN-56/208 - 3x 208 V	HRN-56/480 - 3x 480 V
HRN-56/240 - 3x 240 V	HRN-56/575 - 3x 575 V
HRN-56/400 - 3x 400 V	
- Fixed time delay T1 (500 ms) and adjustable time delay T2 (0 -10 s).

**Technical parameters**

**HRN-56**

	208	240	400	480	575
Monitoring terminals:	L1, L2, L3				
Supply terminals:	L1, L2, L3				
Supply/measured voltage:	3x 208 V L-L (3x120 V L-N) (50/60 Hz)	3x 240 V L-L (3x139 V L-N) (50/60 Hz)	3x 400 V L-L (3x230 V L-N) (50/60 Hz)	3x 480 V L-L (3x277 V L-N) (50/60 Hz)	3x 575 V L-L (3x332 V L-N) (50/60 Hz)
Burden:	max. 2 VA/1 W				
Max. dissipated power (Un + terminals):	2 W				
Level Umin:	adjustable 70 - 95 % Un				
Level Uoff:	60 % Un				
Hysteresis:	2 %				
Max. permanent overload:	AC 3x 276 V	AC 3x 460 V	AC 3x 550 V	AC 3x 660 V	AC 3x 700 V
Peak overload <1s:	AC 3x 300 V	AC 3x 500 V	AC 3x 600 V	AC 3x 700 V	AC 3x 700 V
Time delay T1:	max. 500 ms				
Time delay T2:	adjustable 0 -10 s				

**Output**

Number of contacts:	1x changeover/SPDT (AgNi/Silver Alloy)	
Current rating:	8 A/AC1	
Breaking capacity:	2000 VA/AC1, 240 W/DC	
Inrush current:	10 A	
Switching voltage:	250 V AC/24 V DC	
Indication of state:	red LED	
Mechanical life:	10.000.000 operations	30.000.000 operations
Electrical life (AC1):	100.000 operations	

**Other information**

Operating temperature:	-20 °C to +55 °C (-4 °F to 131 °F)	
Storage temperature:	-30 °C to +70 °C (-22 °F to 158 °F)	
Dielectrical strength:	4 kV (supply - output)	
Operating position:	any	
Mounting:	DIN rail EN 60715	
Protection degree:	IP40 from front panel/ IP10 terminals	IP40 from front panel/ IP20 terminals
Overvoltage category:	III.	
Pollution degree:	2	
Max. cable size (mm <sup>2</sup> ):	solid wire max. 2x 2.5 or 1x 4/ with sleeve max. 1x 2.5 or 2x 1.5 (AWG 12)	max. 1x 2.5, max. 2x 1.5/ with sleeve max. 1x 1.5 (AWG 12)
Dimensions:	90 x 17.6 x 64 mm (3.5" x 0.7" x 2.5")	90 x 52 x 65 mm (3.5" x 2" x 2.6")
Weight:	65 g (2.3 oz.)	65 g (2.3 oz.)
Standards:	EN 60255-1, EN 60255-26, EN 60255-27	

**Description**

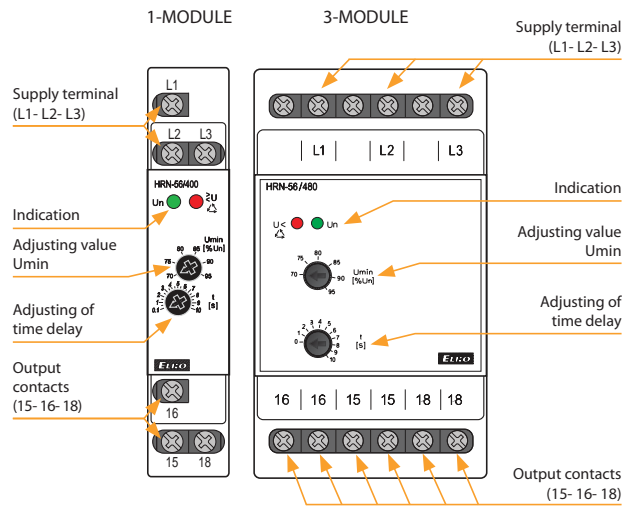

**Function**

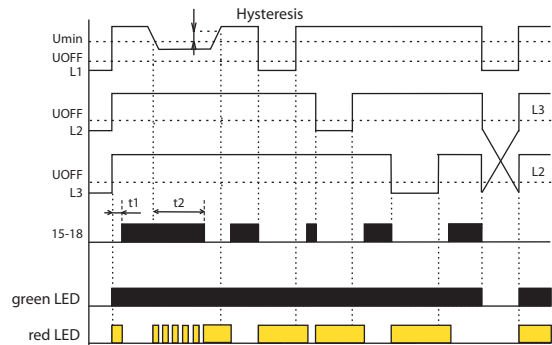

**Connection**

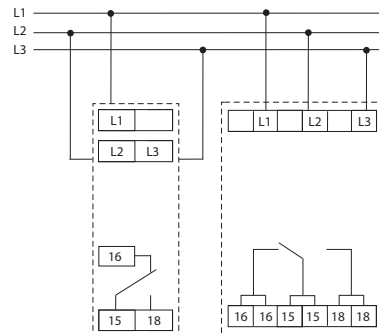

**Symbol**

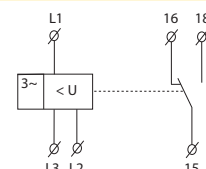

Relay in 3-phase main monitors correct phase sequence and phase failure. Green LED illuminates permanently and indicates energization. In case of phase failure red LED flashes and relay turns off. When changing to faulty state, time delay applies - delay setting is done by potentiometer on the front panel of the device. In case of incorrect phase sequence, red LED shines permanently and relay is open. In case supply voltage falls below 60 % Un (U<sub>off</sub> lower level), relay immediately opens with no delay and faulty state is indicate by red LED.

**HRN-56:** Thanks to supply from all phases, relay is functional also in case of one phase failure.



EAN code  
 HRN-43/230V: 8594030337660  
 HRN-43/400V: 8595188121316  
 HRN-43/24V: 8594030338087  
 HRN-43N/230V: 8594030338216  
 HRN-43N/400V: 8595188120258  
 HRN-43N/24V: 8594030338094

Technical parameters	HRN-43	HRN-43N
<b>Supply</b>		
Supply terminals:	A1 - A2	
Supply voltage:	AC 230 V, AC 400 V, AC/DC 24 V (AC 50/60 Hz)	
Consumption max.:	5 VA/2.5 W (AC 230 V, AC 400 V), 2 VA/1.4 W (AC/DC 24 V)	
Max. dissipated power (Un + terminals):	6.5 W (230 V, 400 V), 5.5 W (24 V)	
Supply voltage tolerance:	-15 %; +10 %	
<b>Measuring circuit</b>		
Voltage set:	3x 400 V (50 Hz)	3x 400 V/230 V (50 Hz)
Monitored terminals:	L1, L2, L3	L1, L2, L3, N
Upper voltage level:	240 - 480 V	138 - 276 V
Bottom voltage level:	35 - 99 % Umax	
Max. permanent overload:	3x 480 V	
Hysteresis:	adjustable 5 % or 10 % of set value	
Asymmetry:	5 - 20 %	
Peak overload < 1 ms:	600 V < 1 ms	350 V < 1 ms
Time delay t1:	fixed, max. 200 ms	
Time delay t2:	adjustable 0.1-10 s	
<b>Accuracy</b>		
Set. accuracy (mechanical):	5 %	
Repeat accuracy:	< 1 %	
Temperature dependence:	< 0.1 %/°C (°F)	
Limit values tolerance:	5 %	
<b>Output</b>		
Number of contacts:	2x changeover/SPDT (AgNi/Silver Alloy)	
Rated current:	16 A/AC1	
Switching capacity:	4000 VA/AC1, 384 W/DC	
Inrush current:	30 A/< 3 s	
Switching voltage:	250 V AC/24 V DC	
Mechanical life:	30.000.000 operations	
Electrical life (AC1):	70.000 operations	
<b>Other information</b>		
Operating temperature:	-20 °C to 55 °C (-4 °F to 131 °F)	
Storage temperature:	-30 °C to 70 °C (-22 °F to 158 °F)	
Dielectrical strength:	4 kV (supply - output)	
Dielectrical strength:	any	
Operating position:	DIN rail EN 60715	
Mounting:	IP40 from front panel/IP20 terminals	
Protection degree:	III.	
Overvoltage category:	2	
Pollution degree:	solid wire max. 1x 2.5 or 2x 1.5/ with sleeve max. 1x 1.5 (AWG 12)	
Max. cable size (mm <sup>2</sup> ):	90 x 52 x 65 mm (3.5" x 2" x 2.6")	
Dimensions:	248 g (110 V, 230 V, 400 V) (8.7 oz.), 146 g (24 V) (5.1 oz.)	
Weight:	EN 60255-1, EN 60255-26, EN 60255-27	
Standards:		

- Monitoring of 3-phase mains:
  - voltage in 2 levels (undervoltage and overvoltage) in range 138-276 V (3x 400 V/230 V) or 280-480 V (3x 400 V)
  - phase asymmetry (can be switched off)
  - phase sequence
  - phase failure.
- Function of second relay (independent/parallel).
- HRN-43:** for circuits 3x 400 V (without neutral).
- HRN-43N:** for circuits 3x 400/230 V (with neutral).
- Galvanically separated supply voltage AC 400 V, AC 230 V, AC/DC 24 V.

## Description

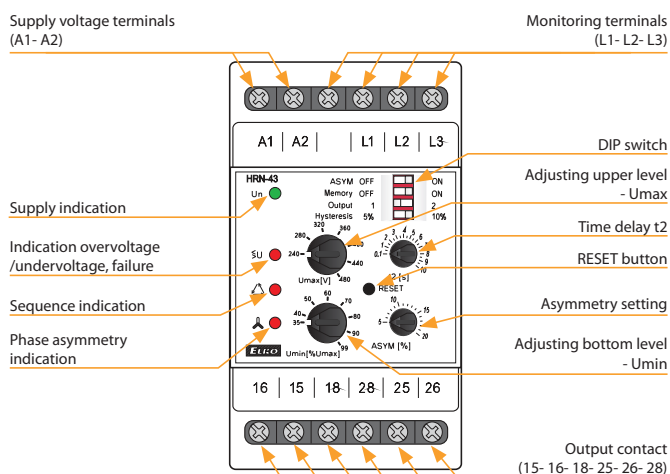

## Description and importance of DIP switches

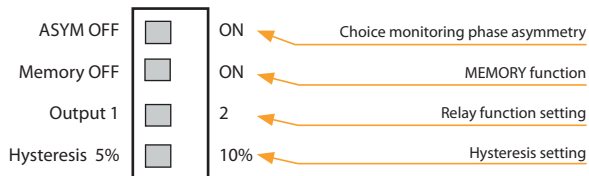

## Connection

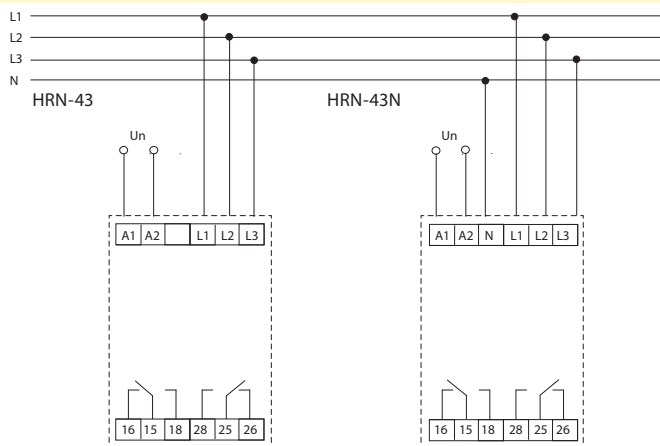

## Symbol

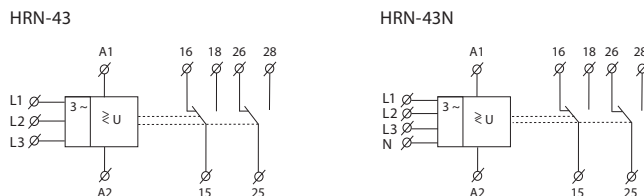

Function

Overvoltage - undervoltage

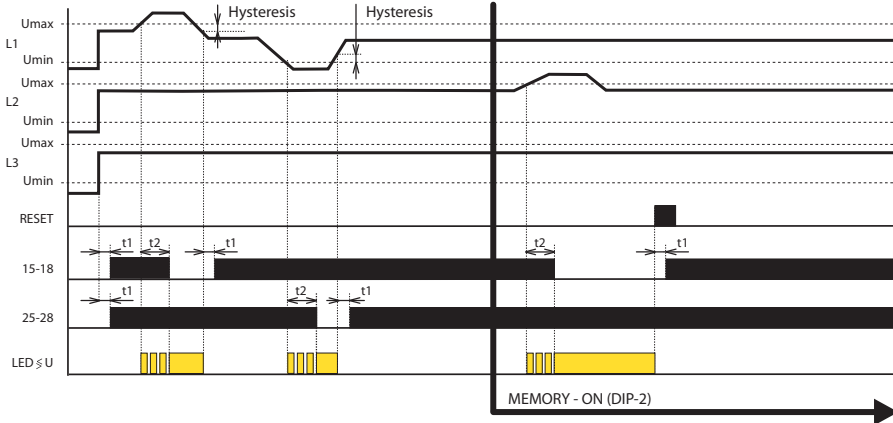

**Legend:**  
 L1, L2, L3 - 3-phase voltage  
 RESET - press of the button on frontal panel  
 t1 - time delay, fixed  
 t2 - time delay, adjustable  
 15-18 output relay 1  
 25-28 output relay 2  
 LED  $\geq U$  - indication overvoltage/undervoltage

**Selection of 2<sup>nd</sup> the relay function:**

In order to monitor 2 levels of voltage, it is possible to select if output relay will respond to each level individually (see the diagram "phase sequence").

Selection via DIP switch Output.

Phase sequence

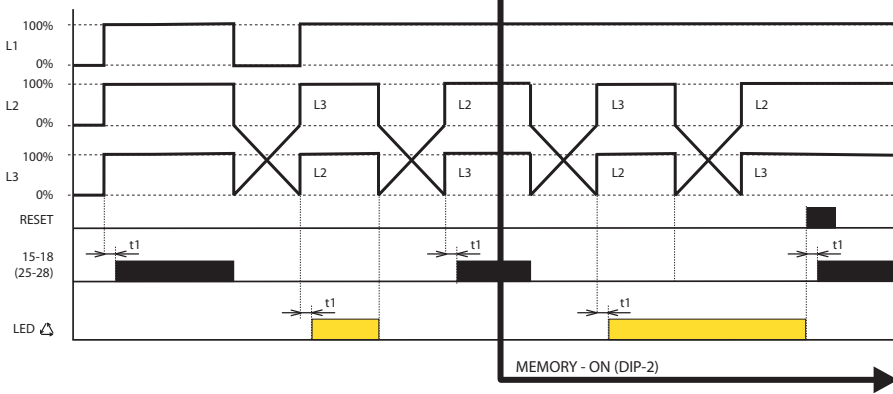

**Legend:**  
 L1, L2, L3 - 3-phase voltage  
 RESET - press of the button on frontal panel  
 t1 - time delay, fixed  
 t2 - time delay, adjustable  
 15-18 output relay 1  
 25-28 output relay 2  
 LED  $\Delta$  - indication of phase sequence

**Selection of 2<sup>nd</sup> relay function:**

The function is not implied in the monitoring phase sequence, the relays are switched in parallel way. DIP switch Output is ignored.

Asymmetry - phase failure

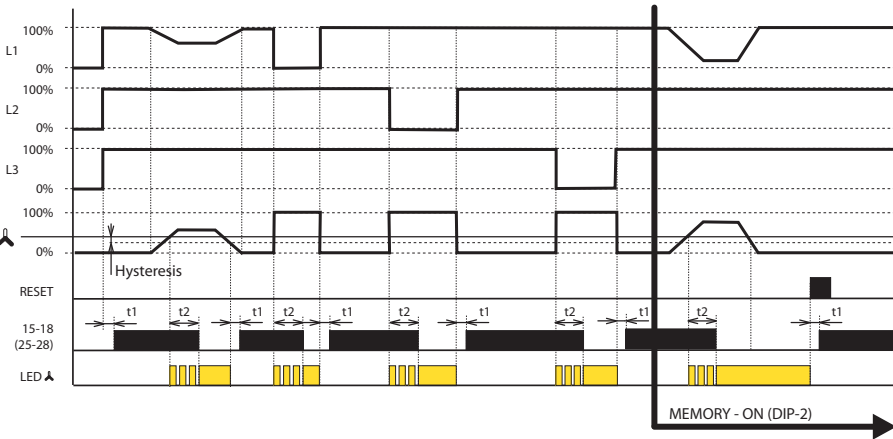

**Legend:**  
 L1, L2, L3 - 3-phase voltage  
 RESET - press of the button on frontal panel  
 t1 - time pause, fixed  
 t2 - time pause, adjustable  
 $\blacktriangle$  - adjustable asymmetry  
 15-18 output contact of relay 1  
 25-28 output contact of relay 2  
 LED  $\blacktriangle$  - asymmetry indicator

**Selection of 2<sup>nd</sup> relay function:**

The function is not implied in the monitoring phase sequence, the relays are switched in parallel way. DIP switch Output is ignored.

Relay is designated to monitor 3-phase circuits. Type HRN-43N controls voltage towards neutral wire, type HRN-43 controls interphase voltage. Relay can monitor voltage in two levels (overvoltage/undervoltage), phase asymmetry, sequence and failure. Each faulty state is indicated by individual LED. By DIP switch (Output) it is possible to define function of the other relay - independent function (1x for overvoltage, 1x for undervoltage) or in parallel. Time delays t1 (fixed) - when changing from faulty to normal state or when de-energized and t2 (adjustable) when changing from normal to faulty state. These delays prevent incorrect conduct and oscillation of output device during short voltage peaks in the main or during gradual voltage decline into normal.

**Voltage control**

Set upper level Umax in range 138 - 276 V (or 240 - 480 V for HRN-43) and lower level Umin in range 35-99 % Umax. In case any phase passes this range, after a delay which eliminated short voltage peaks, contact opens. Output contact again switches after returning back into monitored voltage range and exceeding fixed hysteresis (which is adjustable in two values by DIP switch). In case of failure of two or three phases, the relay is deactivated immediately regardless of the set delay t2.

**Phase sequence**

Monitors correctness of phase sequence. In case of unwanted change output contact breaks. In case of energization of a device with incorrect phase sequence, contact stays opened.

**Asymmetry**

Rate of asymmetry between individual phases is set in a range of 5 - 20 %. In case set asymmetry is exceeded, output relay breaks and LED indicating asymmetry shines. Delays t1, t2 and hysteric are applicable when returning to normal state. Monitoring asymmetry can be switched off by DIP switch ASYM.

NEW



EAN code  
HRN-100: 8595188171229

### Technical parameters

### HRN-100

#### Supply

Supply and measuring:	L1, L2, L3, (N)
Supply voltage:	$U_{LN} = 3 \sim 155 - 500 \text{ V}$ , (AC 45-65 Hz) $U_{LL} = 3 \sim 90 - 288 \text{ V}$ , (AC 45-65 Hz)
Burden (max.):	5 VA

#### Measuring circuit

Selection of the measured circuit:	Phase voltage - 3 phases, 4 wires Interphase voltage - 3 phases, 3 wires
Adjustable Upper (OV) and Lower (UV) voltage levels:	Phase voltage: 90 - 288 VAC Interphase voltage: 155 - 500 VAC
Upper (HC) / lower (LC) limit voltage:	Phase voltage: 310 VAC/85 VAC Interphase voltage: 535 VAC/150 VAC

Adjustable upper (OF) and lower (UF) frequency level:	45 - 65 Hz
---	------------

Adjustable asymmetry:	Absolute: 5 - 99 VAC Percentage: 2 - 50%
-----------------------	---

Level adjustable hysteresis voltage and frequency:	3 - 20 VAC (OV, UV, HC, LC) 0.5 - 2 Hz (OF, UF)
--	--

Adjustable hysteresis asymmetry:	Absolute: 3 - 99 VAC Percentage: 2 - 15%
----------------------------------	---

Accuracy of measured voltage:	+/- 5V
-------------------------------	--------

Accuracy of measured frequency:	+/- 0.3 Hz
---------------------------------	------------

Adjustable delay	0 - 999 s
------------------	-----------

after switching on $P_{on}$ :	(HW initialization 250 ms)
-------------------------------	----------------------------

Adjustable delay $T_{on}$ :	0.5 - 999 s
-----------------------------	-------------

Adjustable delay $T_{off}$ :	0.1 - 999 s
------------------------------	-------------

Fixed delay:	<100 ms (outage, phase sequence) <200 ms (HC, LC), <500 ms (failure of neutral wire)
--------------	---

#### Output

Output contact:	2x changeover (AgSnO <sub>2</sub> )
-----------------	-------------------------------------

Current rating:	5A/AC1
-----------------	--------

Rated current:	1200VA/AC1, 150W/DC1
----------------	----------------------

Inrush current:	240V AC/30V DC
-----------------	----------------

Output power dissipation max.:	5W
--------------------------------	----

Mechanical life:	10.000.000 operations
------------------	-----------------------

Electrical life (AC1):	100.000 operations
------------------------	--------------------

#### Other information

Operating temperature:	-10 to 60 °C (14 to 140 °F)
------------------------	-----------------------------

Storage temperature:	-20 to 70 °C (-4 to 158 °F)
----------------------	-----------------------------

Electrical strength:	4kV (supply - output)
----------------------	-----------------------

Operating position:	any
---------------------	-----

Mounting:	DIN rail EN 60715
-----------	-------------------

Protection degree:	IP20 terminals/IP40 from front panel
--------------------	--------------------------------------

Overvoltage category:	III.
-----------------------	------

Pollution degree:	2
-------------------	---

Max. cable size (mm <sup>2</sup> ):	max. 1x 2.5, max. 2x 1.5 /with sleeve max. 1x 2.5
-------------------------------------	--

Dimensions:	90 x 36 x 66,5 mm (3.6" x 1.5" x 2.7")
-------------	--

Weight:	132 g (4.7 oz.)
---------	-----------------

Standards:	EN 61812-1, EN IEC 63044
------------	--------------------------

- 3-wire or 4-wire connection (with or without neutral).
- Optionally monitors high and low voltage & frequency in 3-phase circuits.
- Allows monitoring of failure, sequence and phase asymmetry incl. neutral failure (only for 4-wire connection).
- The product is powered by a monitored voltage.
- Both output contacts can be set individually.
- Measures the true RMS value of True RMS.
- Optional setting of output contact response delay and measured error condition incl. Possibility of delayed response of the output contact after power supply connection.
- Possibility of manual or automatic (default setting) transition from error state (memory).
- Optional closing or opening of the output contact when measuring an error condition (Fail Safe/Non Fail Safe).
- Password protection against unauthorized changes to settings.
- Digital backlit display with the ability to monitor the current state of the network incl. possible failures.
- The last five error states are stored in a backed up history that is possible to view
- Sealable transparent cover for display and controls.

### Description

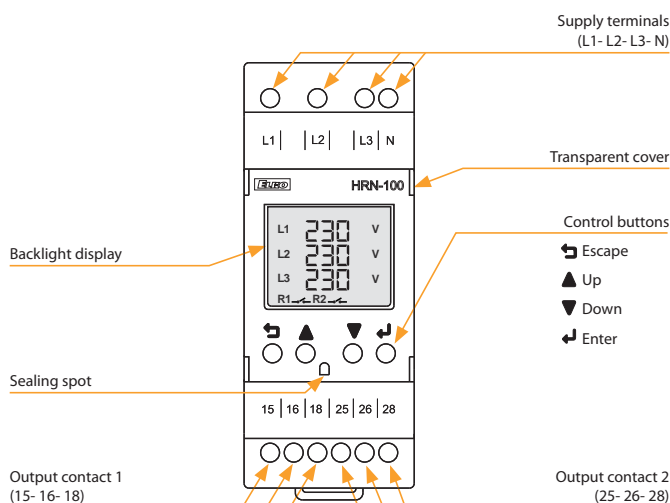

### Description of displayed elements on the screen

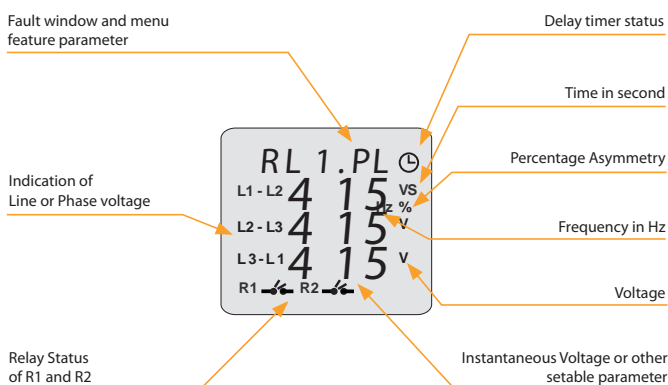

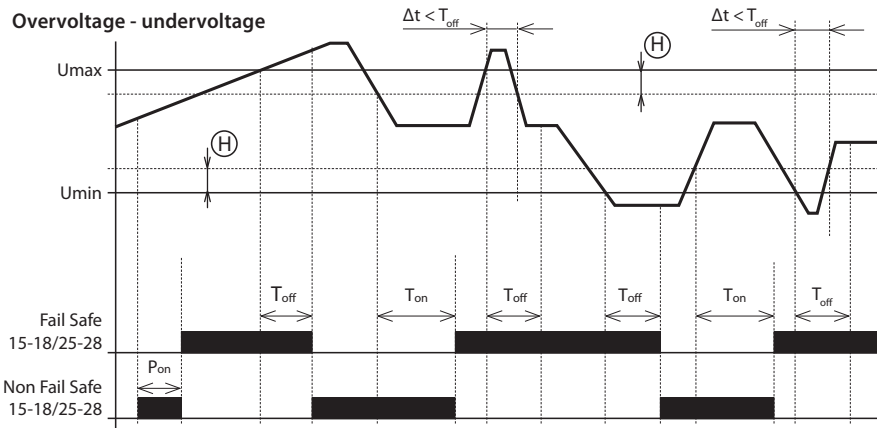

**Graph legend:**

- P<sub>on</sub> - Power ON delay (adjustable response delay after power supply connection)
- P<sub>on</sub> = 0 - 999 s
- P<sub>on</sub> = min. 250 ms (hardware initialization)
- T<sub>on</sub> - ON Delay (Delay to OK state)
- T<sub>on</sub> = 0,5 - 999 s
- T<sub>off</sub> - OFF delay (delay to error state)
- T<sub>off</sub> = 0,1 - 999 s
- T<sub>off</sub> - adjustable for errors OV, UV, OF, UF & asymmetry
- T<sub>off</sub> - Outage, phase sequence <100ms
- Neutral wire interruption <500ms
- Δt - Duration of the error condition
- (H) Hysteresis

**Overvoltage - undervoltage**

- After the supply/monitored voltage is connected, the delay is timed. During the timing, the relay is in an error state - it is open in FAIL SAFE mode. After a pause, if the monitored voltage is in the range Umin ... Umax, the relay closes.
- If the monitored voltage exceeds the set value Umax, the delay time to the error state (Toff) starts. After the interruption, the relay opens.
- If the monitored voltage falls below the Umax value reduced by the set hysteresis, the delay time starts to OK (Ton). After temporarily, the relay closes.
- If the duration of the error condition (Δt) is shorter than the set value Toff, the state of the relay does not change.
- If the monitored voltage falls below the value Umin, the delay time to the error state (Toff) starts. After the interruption, the relay opens.
- If the monitored voltage exceeds the value Umin increased by the set hysteresis, the delay time starts to the OK state (Ton). After temporarily, the relay closes.
- If the duration of the error condition (Δt) is shorter than the set value (Toff), the state of the relay does not change.

**Phase sequence**

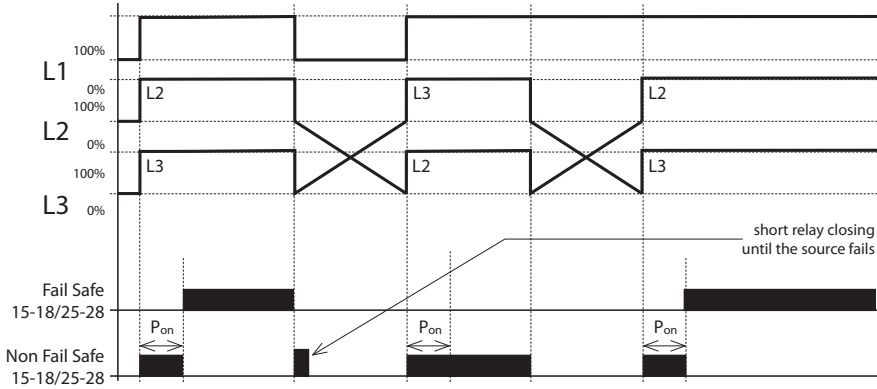

**Graph legend:**

- P<sub>on</sub> - Power ON delay (adjustable response delay after power supply connection)
- P<sub>on</sub> = 0 - 999 s
- P<sub>on</sub> = 0 - 999 s, (default 5 s)
- P<sub>on</sub> = min. 250 ms (hardware initialization)

**Phase sequence**

- After the supply / monitored voltage is connected, it delays the delay (Mon) - during timing the relay is in an error state - in FAIL SAFE mode it is open. After a pause, if the phase sequence is correct, the relay closes.
- If the phase sequence is incorrect after switching off Pon, the relay remains open (error state).

**Asymmetry, phase failure**

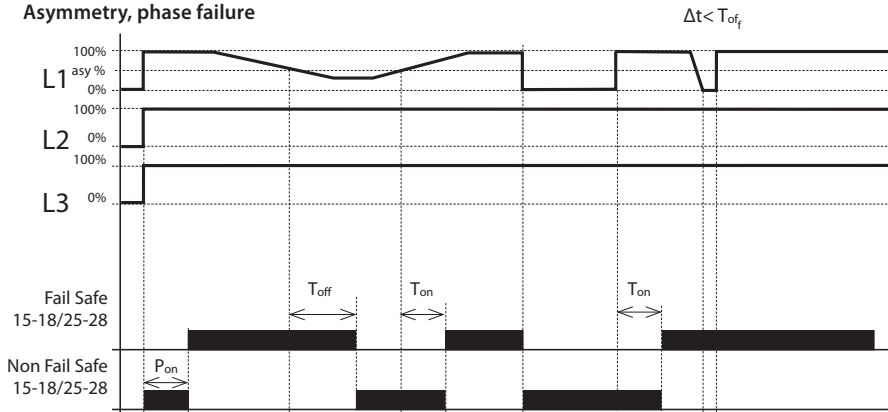

**Graph legend:**

- P<sub>on</sub> - Power ON delay (adjustable response delay after power supply connection)
- P<sub>on</sub> = 0 - 999 s
- P<sub>on</sub> = min. 250 ms (hardware initialization)
- T<sub>on</sub> - ON Delay (Delay to OK state)
- T<sub>on</sub> = 0,5 - 999 s
- T<sub>off</sub> - OFF delay (delay to error state)
- T<sub>off</sub> = 0,1 - 999 s
- T<sub>off</sub> - adjustable for errors OV, UV, OF, UF & asymmetry
- T<sub>off</sub> - Outage, phase sequence <100ms
- Neutral wire interruption <500ms
- Δt - Duration of the error condition

**Asymmetry, phase failure**

- After the supply / monitored voltage is connected, the delay De - time - during the timing the relay is in an error state - in FAIL SAFE mode it is open. After a pause, if the phase asymmetry is lower than the set value (absolute or percentage - see technical parameters), the relay closes.
- If the phase asymmetry exceeds the set value, the delay time to the error state (Toff) begins. When the relay temporarily opens.
- If the phase asymmetry falls below the set value, the delay time starts to OK (Ton). After temporarily, the relay closes.
- If the duration of the error condition (Δt) is shorter than the set value Toff, the state of the relay does not change.
- If a phase failure occurs, the delay time to the error state (Toff) begins. After the interruption, the relay opens.
- If the interrupted phase resumes, the delay time starts to OK (Ton). After temporarily, the relay closes.
- If the duration of the error state (Δt) is shorter than the set value Toff, the state of the relay does not change.

Connection

3 - wire connection

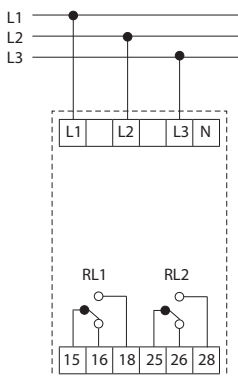

4 - wire connection

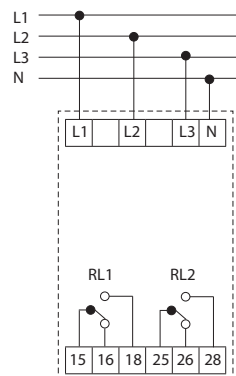

Description of controls and signaling

Relay contact status

Relay mode	Device Healthy Condition	Device Faulty Condition
Fail Safe	15 & 25 (Pole)  18 & 28 (NO)	15 & 25 (Pole)  18 & 28 (NO)
Non fail Safe	15 & 25 (Pole)  18 & 28 (NO)	15 & 25 (Pole)  18 & 28 (NO)

Display of faults

Relay mode	Meaning
"FLT.NF"	Neutral Open
"FLT.LC"	Low Cut off
"FLT.HC"	High Cut off
"RLx.PL"	Phase Loss
"RLx.PR"	Phase Reverse
"RLx.ASY"	Voltage Asymmetry
"RLx.OF"	Over Frequency
"RLx.UF"	Under Frequency
"RLx.OV"	Over Voltage
"RLx.UV"	Under Voltage

Note: RLx indicate RL1 & RL2

Key function

	To enter in setup menu(Long press > 1Sec) To return to main screen or previous menu while in edit or view mode To abort changed value or parameter
	To scroll parameters upward To change/increment parameter value in edit mode To enter into Run mode menu and view instantaneous measurement values frequency, Asymmetry & voltages (Key press < 500ms)
	To scroll parameters downward To change/decrement parameter value in edit mode To enter into History menu mode & view fault log history(Key press < 500ms).
	To select and save parameter value in edit mode To reset the product from latch mode (Long press > 1Sec)
	Combine key press to view read only setup menu (Long press > 1Sec)



EAN code  
MPS-1: 8595188145978

Technical parameters		MPS-1
Supply voltage:	AC 3x 400/230 V (50/60 Hz)	
Supply voltage tolerance:	+20 %, -75 %	
Power consumption:	max. 1 VA/0.5 W	
<b>Indication</b>		
LED not illuminated:	0 to 50 V/45 to 0 V	
LED illuminated		
yellow:	50 to 207 V/195.5 to 45 V	
green:	207 to 264.5 V/253 to 195.5 V	
red:	264.5 to 276 V/276 to 253 V	
<b>Other information</b>		
Design:	1 MODULE	
Mounting:	DIN rail EN60715	
Operating position:	any	
Coverage:	panel IP40, terminals IP10	
Overvoltage category:	III.	
Contamination level:	2	
Max. cable size (mm <sup>2</sup> ):	solid wire max. 2x 2.5 or 1x 4/ with sleeve max. 1x 2.5 or 2x 1.5 (AWG 12)	
Working temperature:	-20 °C to 55 °C (-4 °F to 131 °F)	
Storage temperature:	-30 °C to 70 °C (-22 °F to 158 °F)	
Dimensions:	90 x 17.6 x 64 mm (3.5" x 0.7" x 2.5")	
Weight:	48 g (1.7 oz.)	
Standards:	EN 60947-1, EN 60947-5-1	

- Used for optical signaling of the voltage level in 3-phases.
- Each phase features LED signaling broken is divided by color into voltage levels:
  - voltage in tolerance of  $\pm 15\%$  - green
  - overvoltage - red
  - undervoltage - yellow
  - voltage < 50 V - LED not illuminated.
- 4-wire connection - L1, L2, L3, N.
- Monitors phase voltages against neutral wire.
- Not dependent upon order of phases.

**Description of device**

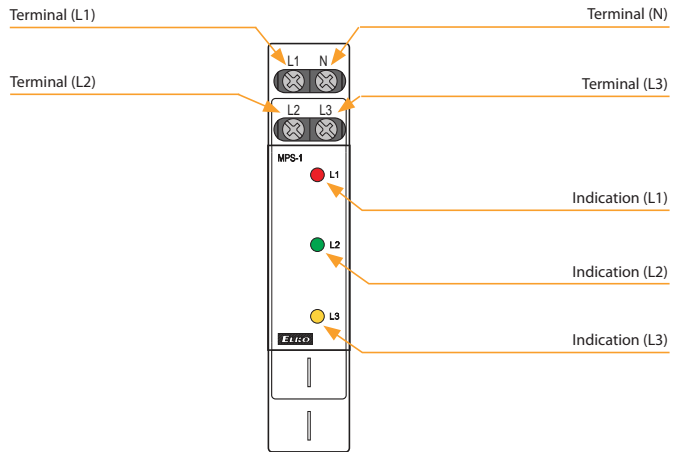

**Function**

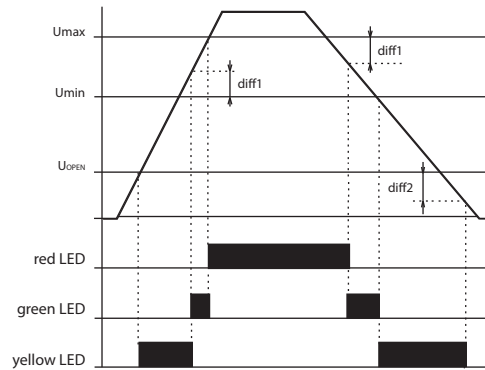

After connecting the supply voltage, the LED illuminates - the color corresponds to the voltage size of individual phases. If the phase voltage drops under 40 V (phase outage), the corresponding LED is not illuminated.

**Connection**

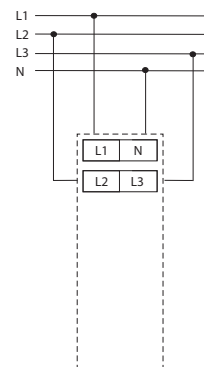



EAN code  
 COS-2/230V: 8595188155434  
 COS-2/110V: 8595188152280  
 COS-2/400V: 8595188152365  
 COS-2/24V: 8595188155441

Technical parameters		COS-2
<b>Supply</b>		
Supply terminals:	A1 - A2	
Voltage range:	AC 230 V, AC 110 V, AC 400 V or AC/DC 24 V (AC 50/60 Hz)	
Burden max.:	2.5 W/5 VA (AC 110 V, AC 230 V, AC 400 V), 1.4 W/2 VA (AC/DC 24 V)	
Max. dissipated power (Un + terminals):	4 W	
Operating range:	-15 %; +10 %	
<b>Measuring</b>		
Voltage set:	3x 400 V/230 V (50/60 Hz)	
Terminals:	L1, L2, L3, B1	
Upper level cos-φ:	adjustable 0.1 - 0.99	
Bottom level cos-φ:	adjustable 0.1 - 0.99	
Max. permanent voltage:	(input L1, L2, L3) AC 3x 460 V	
Current range:	0.1 - 16 A	
Current overloading:	20 A (< 3 sec.)	
Hysteresis:	adjustable 5 % or 10 %	
Time delay t1:	adjustable 0.1 - 10 s	
Time delay t2:	adjustable 0.1 - 10 s	
<b>Accuracy</b>		
Accuracy setting (mechanical):	5 %	
Accuracy of repetition:	< 1 %	
Temperature dependance:	< 0.1 %/°C (°F)	
Limit values tolerance:	5 %	
<b>Output</b>		
Number of contacts:	2x changeover/SPDT (AgNi/Silver Alloy)	
Current rating:	16 A/AC1	
Breaking capacity:	4000 VA/AC1, 384 W/DC	
Inrush current:	20 A/< 3 s	
Switching voltage:	250 V AC/24 V DC	
Output indication:	yellow LED	
Mechanical life:	30.000.000 operations	
Electrical life (AC1):	70.000 operations	
<b>Other information</b>		
Operating temperature:	-20 °C to 55 °C (-4 °F to 131 °F)	
Storage temperature:	-30 °C to 70 °C (-22 °F to 158 °F)	
Dielectrical strength:	4 kV (supply - output)	
Operating position:	any	
Mounting:	DIN rail EN 60715	
Protection degree:	IP40 from front panel/IP20 terminals	
Overvoltage category:	III.	
Pollution degree:	2	
Max. cable size (mm <sup>2</sup> ):	max. 1x 2.5, max. 2x1.5/ with sleeve max. 1x 1.5 (AWG 12)	
Dimensions:	90 x 52 x 65 mm (3.5" x 2" x 2.6")	
Weight:	243 g/8.6 oz (230 V, 110 V, 400 V); 141 g/5 oz (24 V)	
Standards:	EN 60255-1, EN 60255-26, EN 6255-27	

- Relay monitors phase shift between current and voltage in 3-phase or 1-phase networks - evaluates COS φ (replacement COS-1).
- The relay is designed to monitor overload/relieve the motors.
- Relay is designed for 3 x 400/230 V circuits.
- Galvanically isolated power supply AC 230 V, AC 110 V, AC 400 V or AC/DC 24 V.
- Adjustable upper and lower level COS φ.
- Possibility to extend the current range using a current transformer.
- Two output relays (for each level independent).
- Adjustable delay eliminating engine start-up.

**Description**

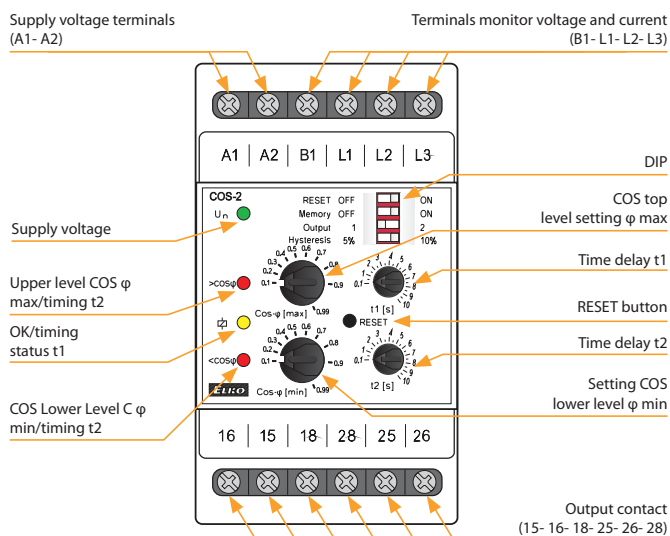

**Description and importance of DIP switches**

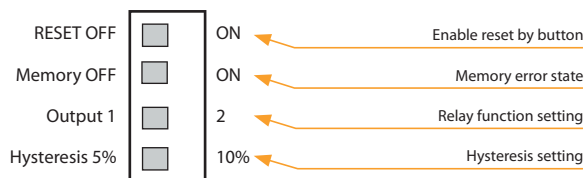

**Connection**

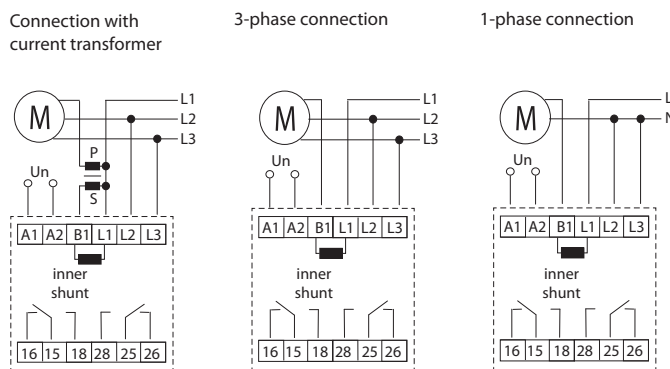

**Symbol**

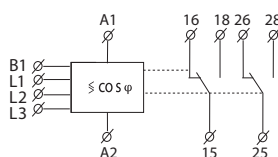



Function

Status after switching on power, two relay mode

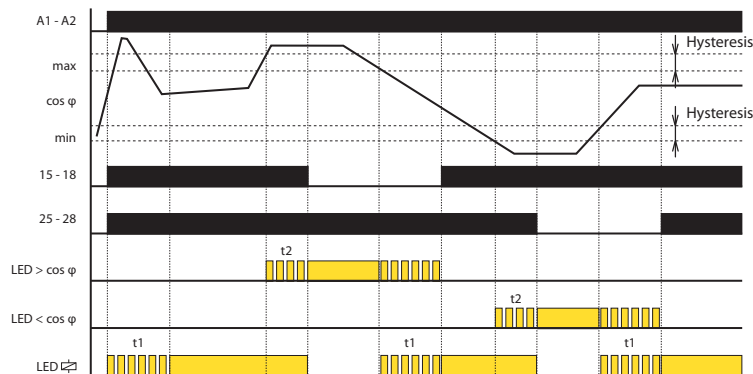

Memory on, two relay mode

decrease (loss) of current

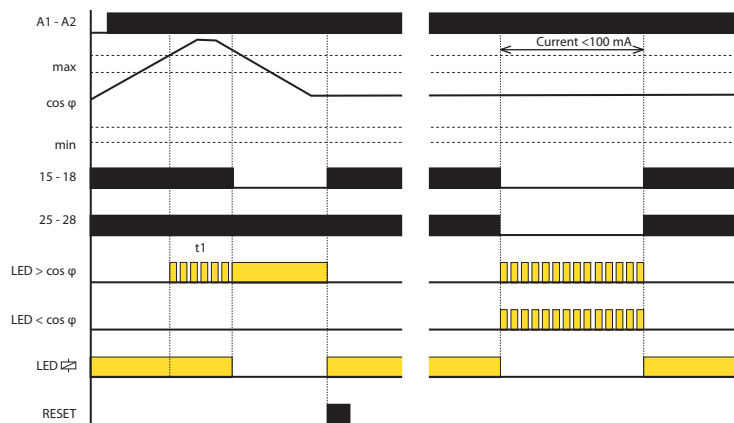

After powering on, the device sets the delay time t1 and yellow LED flashes. Both relays are switched on. The delay serves to eliminate a faulty state when starting the motor. After the time delay t1 begins monitoring COS φ only.

If the COS φ is in the band between the upper and lower limits set, both relays are switched on and the yellow LED is on.

If the COS φ is outside the set limits (> COS φ max or <COS φ min), an error condition occurs - the time t2 is delayed while the red LED corresponding to the COS φ blinks at the same time. After the time delay t2 red LED lights and the corresponding relay remains off.

When the COS φ returns to set limits, the time t1 is delayed and the yellow LED flashes at the same time as the corresponding red LED. After the time delay stops blinking yellow LED, the corresponding red LED turns off and the relay switches on.

At low wattage (<100 mA) or with a power failure, an error is reported by the simultaneous blinking of both red LEDs. After resuming the voltage or the current being watched, the relay returns to the normal state where the COS φ value is monitored.

When the memory is turned off (DIP switch 2 OFF) and the allowable reset (DIP switch 1 ON), the pressing state is reached after the power is turned on, i.e. flashing yellow LED, both relays are switched on, with time delay t1.

When the memory (DIP switch 2 ON) is in an error state (high or low value for cos φ) it should be reset (by pressing the RESET button).



EAN code  
HRF-10: 8595188144827

Technical parameters	HRF-10
Supply and monitoring terminals:	L, N
Supply voltage:	161 - 500 V
Rated frequency $F_n$ :	(50/60/400 Hz)
Burden (max):	1.7 VA/1.1 W
Max. dissipated power ( $U_n$ + terminals):	2 W
Overload capacity	
- continuous:	500 V
- max. 10 s:	550 V
Frequency $F_{max}$ :	adjustable 80 - 120 % $F_n$
Frequency $F_{min}$ :	adjustable 80 - 120 % $F_n$
Difference:	adjustable 0.5 - 5 % $F_n$
Delay (until failure):	adjustable 0.5 - 10 s
Opening level ( $U_{open}$ ):	161 V
Output relay - contact:	2x changeover/SPDT (AgNi) gilded
AC contact capacity:	250 V/8 A, max. 2000 VA
DC contact capacity:	30 V/8 A
Mechanical life:	30.000.000 operations
<b>Other information</b>	
Operational temperature:	-20 °C to 55 °C (-4 °F to 131 °F)
Storing temperature:	-30 °C to 70 °C (-22 °F to 158 °F)
Dielectrical strenght (supply - relay contact):	4 kV/1 min.
Protection degree:	III.
Overvltage category:	2
Pollution degree:	IP40 from font panel/IP20 terminals
Profile of connecting wires (mm <sup>2</sup> ):	max. 2x 1.5/1x 2.5 (AWG 12)
Dimensions:	90 x 52 x 64 mm (3.5" x 2" x 2.6")
Weight:	127 g (4.5 oz.)
Standards:	EN 61000-6-2, EN 61000-6-4, EN 60255-1, EN 60255-26, EN 60255-27

### Connection

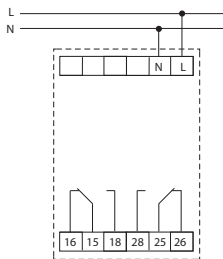

### Rated frequency setting

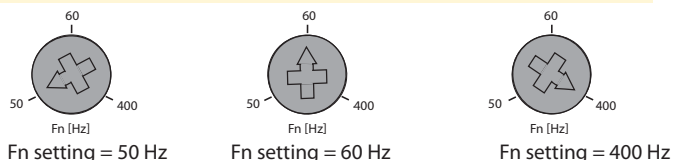

- The relay serves to monitor frequency of AC voltage, e.g. in photovoltaic power stations, generators.
- The monitored frequency 50/60/400 Hz is selected by a switch.
- Two adjustable levels of frequency ( $F_{min}$ ,  $F_{max}$ ) in the range of 80 - 120 %  $F_n$ .
- Adjustable difference level.
- Adjustable delay level.

### Device description

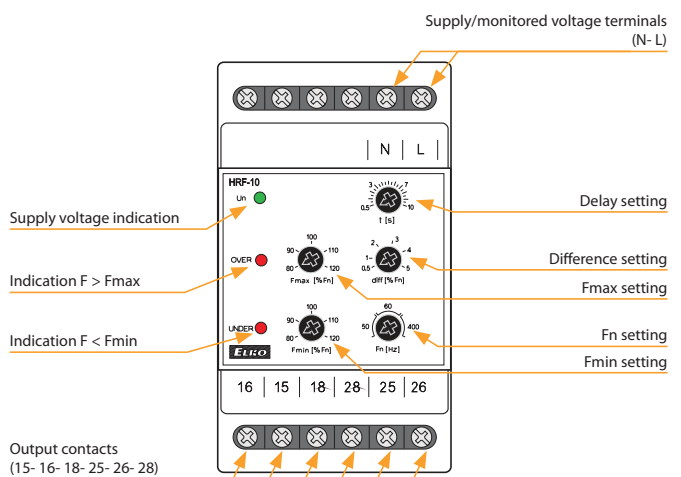

### Functions

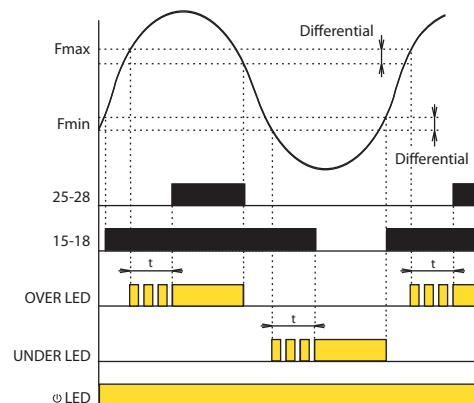

After the supply (monitored) voltage is connected, the green LED is on.

If the value of the monitored frequency falls within the range between the two set levels  $F_{min}$  -  $F_{max}$  no red LED is on. The relay UNDER is triggered (contacts 15-16-18) and the relay OVER is disconnected (contacts 25-26-28).

If the monitored frequency exceeds the set level  $F_{max}$ , the relay OVER is triggered after the set delay timing elapses and the red LED OVER goes on. The red LED flashes during the timing.

If the monitored frequency drops below  $F_{max}$  - difference, the relay is activated without delay and the red LED OVER goes off.

If the monitored frequency drops below the set level  $F_{min}$ , the relay UNDER is disconnected after the set delay timing elapses and the red LED UNDER goes on. The red LED flashes during the timing. If the monitored frequency exceeds the level  $F_{min}$  + the difference, the relay is triggered without delay and the red LED UNDER goes off.

If the monitored voltage is lower than the opening level  $U_{open}$  both the relays are disconnected and both the LED (UNDER and OVER) start flashing slowly - indicating insufficient supply voltage.

AC



**PRI-32**

Monitoring by current transformer (wire through an opening, galv. separated, without heat loss), adjust. current 1-20 A, multivoltage AC 24-240 and DC 24 V, output 8 A changeover. page 108



**PRI-50**

Undercurrent monitoring relay, measurement via built-in current transformer, rated current 5 A (suitable for current transformer), AC / DC supply 24 - 240V, output 8A prep page 109



**PRI-51**

Monitoring of current by in-built transformer, 7 ranges, range 5 A is suitable for current transformer, supply and output as PRI-32, difference from PRI-32: direct monitoring and finer ranges (higher sensitivity) = higher accuracy in measuring. page 110



**PRI-52**

For scanning the current up to 25 A. Long distance device diagnostics (black-out, increase of take-off) Priority relay. Supplying voltage AC 230 V. Output 8A/SPST switching over. page 111



**PRI-53**

For monitoring the current in three-phase devices. Power supply: 24-240 V AC/ DC, galvanically separated from the circuit of the monitored current 2 types depending on the strength of rated current In (1 A, 5 A). page 112

AC/DC



**PRI-41**

(Hysteresis) 3 inputs divided into 3 ranges (selectable by a switch). page 113



**PRI-42**

(Window) as PRI-41 but function "WINDOW". page 113

Relay for current monitor

Type	Design	Supply voltage	Secure variables			Setting					Description	Page	
			Phases	Range	∧	∨	Delay	Hysteresis	Memory Errors	∧			∨
PRI-32	1-M	AC 24-240 V DC 24 V	1	AC 1-20 A	●	x	x	x	x	●	x	Exceeding the current value - the current flowing through the monitored conductor must not exceed 100 A even on a short-term basis.	108
PRI-50	1-M	AC/DC 24 - 240 V	1	AC 2-6 A	x	●	●	●	x	x	●	Undercurrent monitoring relay, measurement via built-in current transformer, rated current 5 A (suitable for current transformer), AC / DC supply 24 - 240 V, output 8 A prep.	109
PRI-51/0,5 PRI-51/1 PRI-51/0.1-10 A PRI-51/2 PRI-51/5 PRI-51/8 PRI-51/16	1-M	AC 24-240 V DC 24 V	1	AC 0.05 - 0.5 A AC 0.1 - 1 A AC 0.1-10 A AC 0.2 - 2 A AC 0.5 - 5 A AC 0.8 - 8 A AC 1.6 - 16 A	●	x	●	x	x	●	x	May be used for scanning the current from the current transformer - up to 600 A. Power supply is galvanically separated from the measured current.	110
PRI-52	1-M	AC 230 V	1	AC 0.5 - 25 A	●	x	●	x	x	●	x	May be used for scanning the current from the external current transformer - up to 600 A.	111
PRI-53/1 PRI-53/5	6-M	AC/DC 24 - 240 V	3	AC 3 x 0.4 - 1.2 A AC 3 x 2 - 6 A	●	●	●	x	x	●	●	Monitors the drop in the strength of current below the preset value. Monitors exceeding the preset value.	112
PRI-41/230 V PRI-41/24 V	3-M	AC 230 V AC/DC 24 V	1	AC/DC 1.6 A AC/DC 5 A AC/DC 16 A	●	●	●	●	●	●	●	The adjustable delay for elimination of short-term outages and peaks for every level. Galvanically separated power supply.	113
PRI-42/230 V PRI-42/24 V	3-M	AC 230 V AC/DC 24 V	1	AC/DC 1.6 A AC/DC 5 A AC/DC 16 A	●	●	●	●	●	●	●	The adjustable delay for elimination of short-term outages and peaks for every level. Galvanically separated power supply.	



EAN code  
PRI-32: 8595188121965

Technical parameters		PRI-32
<b>Supply circuit</b>		
Supply terminals:	A1 - A2	
Voltage range:	AC 24 - 240 V, DC 24 V (AC 50/60 Hz)	
Burden:	max. 1.5 VA/1 W	
Max. dissipated power (U <sub>n</sub> + terminals):	2 W	
Operating range:	-15 %; +10 %	
<b>Measuring circuit</b>		
Current range:	1 - 20 A (AC 50/60 Hz)	
Current adjustment:	potentiometer	
<b>Accuracy</b>		
Setting accuracy (mech.):	5 %	
Repeat accuracy:	< 1 %	
Temperature dependency:	< 0.1 %/°C (°F)	
Limit values tolerance:	5 %	
Overload capacity:	max. 100 A/10 s	
<b>Output</b>		
Number of contacts:	1x changeover/SPDT (AgNi/Silver Alloy)	
Current rating:	8 A/AC1	
Breaking capacity:	2000 VA/AC1, 240 W/DC	
Output indication:	red LED	
<b>Other information</b>		
Operating temperature:	-20 °C to 55 °C (-4 °F to 131 °F)	
Storage temperature:	-30 °C to 70 °C (-22 °F to 158 °F)	
Dielectrical strength:	4 kV (supply - output)	
Operating position:	any	
Mounting:	DIN rail EN 60715	
Protection degree:	IP40 from front panel/IP10 terminals	
Overvoltage category:	III.	
Pollution degree:	2	
Max. cable size (mm <sup>2</sup> ):	solid wire max. 2x 2.5 or 1x 4, with sleeve max. 1x 2.5 or 2x 1.5 (AWG 12)	
Dimensions:	90 x 17.6 x 80.5 mm (3.5" x 0.7" x 3.2")	
Weight:	75 g (2.6 oz.)	
Standards:	EN 60255-1, EN 60255-26, EN 60255-27	

- Current transformer is a part of the product. Inside this transformer there is a wire which senses the volume of flowing current.
- This construction reduces thermal stress of product when compared with conventional solutions with inbuilt shunt, and increases current range up to 20 Amps, and galvanically separates monitored circuit.
- For heating bars in sliding rails, heating cables, indication of current flow, controlling of 1-phase motor consumption,...
- Supply is galvanically separated from measuring current.
- Current exceeding - current flowing through monitored wire must not exceed 100 A.

**Description**

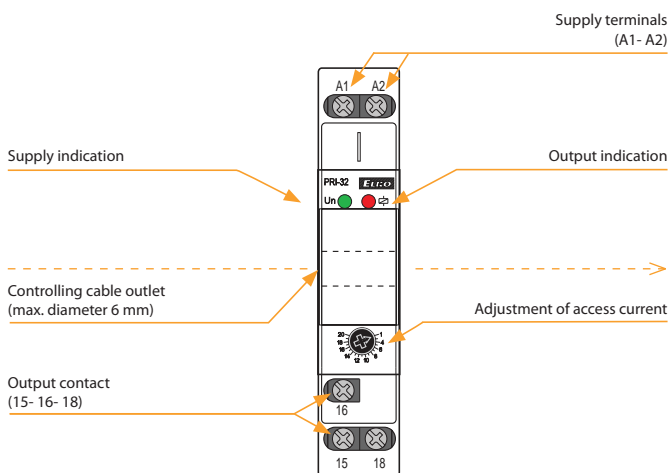

**Function**

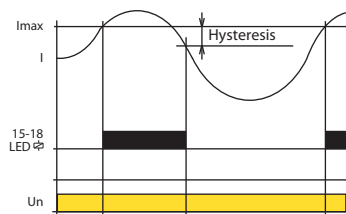

Monitoring relay PRI-32 serves to monitor current level in single phase AC circuits. Due to its fluent adjustment of release current, it is predestined for applications with necessity of current flow indication, and can be used as precedence relay. Output relay is off in normal state. In case the set current level is exceeded, it switches. Multivoltage supply is an advantage.

**Connection**

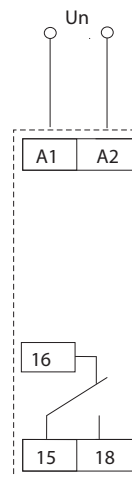

**Symbol**

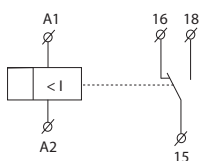



EAN code  
PRI-50: 8595188142083

Technical parameters		PRI-50
<b>Supply</b>		
Supply terminals:	A1 - A2	
Voltage range:	AC/DC 24 - 240 V (AC 45/65 Hz)	
Burden:	max. 3 VA/1.2 W	
Max. dissipated power (Un + terminals):	2 W	
Supply voltage tolerance:	±10 %	
<b>Measuring circuit</b>		
Load:	between B1 - B2	
Current range:	AC 2 - 6 A	
Max. permanent current:	10 A	
Inrush overload < 3 s:	50 A	
Current adjustment:	potentiometer	
Time delay:	adjustable, 0.5 - 10 s	
<b>Accuracy</b>		
Setting accuracy (mechanical):	5 %	
Limit values tolerance:	2.5 %	
Hysteresis (fault to OK):	1 %	
<b>Output</b>		
Number of contacts:	1x changeover/SPDT (AgNi/Silver Alloy)	
Current rating:	8 A/AC1	
Breaking capacity:	2000 VA/AC1, 240 W/DC	
Output indication:	red LED	
<b>Other information</b>		
Operating temperature:	-20 °C to 55 °C (-4 °F to 131 °F)	
Storage temperature:	-30 °C to 70 °C (-22 °F to 158 °F)	
Dielectrical strength:	4 kV (supply - output)	
Operating position:	any	
Mounting:	DIN rail EN 60715	
Protection degree:	IP40 from front panel/IP10 terminals	
Overvoltage category:	III.	
Pollution degree:	2	
Max. cable size (mm <sup>2</sup> ):	solid wire max. 2x 2.5 or 1x 4/ with sleeve max. 1x 2.5 or 2x 1.5 (AWG 12)	
Dimensions:	90 x 17.6 x 64 mm (3.5" x 0.7" x 2.5")	
Weight:	70 g ( 2.5 oz.)	
Standards:	EN 60255-1, EN 60255-26, EN 6255-27	

- It is used, for example, to monitor the operation of pumps, interruptions of radiators or lighting.
- Continuous setting of tripping current by potentiometer from 2 to 6 A AC.
- Monitors the decrease in current magnitude below the level of Imin.
- Adjustable delay 0.5 - 10 s (eliminate short current peaks, on of short...).
- Possible to use for scanning of current from current transformer.
- Power supply galvanically separated from the monitored current circuit.

**Description**

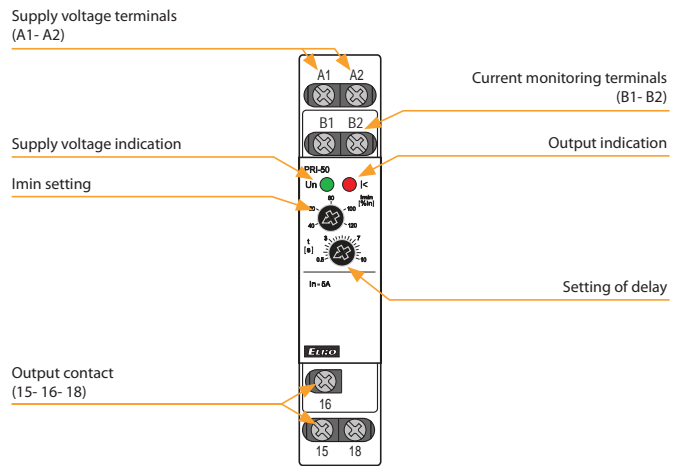

**Function**

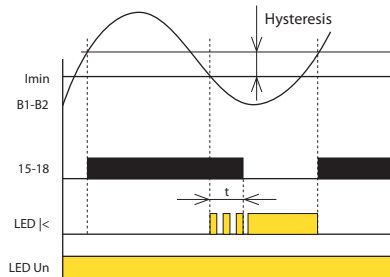

When the supply voltage is connected, the green LED lights up.

If the magnitude of the monitored current is higher than the set level Imin, the relay is closed and the red LED is not lit. If the magnitude of the monitored current falls below the Imin level, the relay opens after the set delay has elapsed and the red LED lights up. The red LED flashes during the delay. If the magnitude of the monitored current returns above the level of Imin + hysteresis, the relay closes without delay and the red LED goes out.

**Connection**

**Example Connection:**  
PRI-50 with current transformer for current range increase.

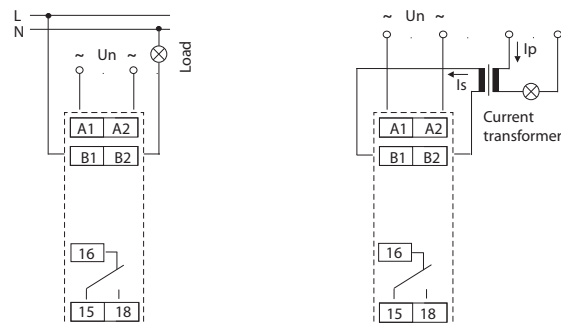



EAN code  
 PRI-51/0.5A: 8595188142885  
 PRI-51/1A: 8595188124904  
 PRI-51/2A: 8595188124911  
 PRI-51/5A: 8595188124928  
 PRI-51/8A: 8595188124935  
 PRI-51/0.1-10A: 8595188155717  
 PRI-51/16A: 8595188124942

Technical parameters		PRI-51
<b>Supply circuit</b>		
Supply terminals:	A1 - A2	
Voltage range:	AC 24 - 240 V and DC 24 V (AC 50/60 Hz)	
Burden:	max. 25 VA/1.6 W	
Max. dissipated power (U <sub>n</sub> + terminals):	2.5 W	
Supply voltage tolerance:	-15 %; +10 %	
<b>Measuring circuit</b>		
Load:	between B1 - B2	
Current range:	PRI-51/0.5 A: AC 0.05-0.5 A    PRI-51/8 A: AC 0.8-8 A PRI-51/1 A: AC 0.1-1 A        PRI-51/0.1-10 A: AC 0.1-10 A PRI-51/2 A: AC 0.2-2 A        PRI-51/16 A: AC 1.6-16 A PRI-51/5 A*: AC 0.5-5 A        (AC 50/60 Hz)	
Max. permanent current:	PRI-51/0.5 A: 2 A PRI-51/1 A: 4 A PRI-51/2 A: 8 A PRI-51/0.1-10 A: 10 A PRI-51/5 A, PRI-51/8 A, PRI-51/16 A: 17 A	
Inrush overload <1ms:	50 A	
Current adjustment:	potentiometer	
Time delay:	adjustable 0.5 - 10 s	
<b>Accuracy</b>		
Setting accuracy (mechanical):	5 %	
Repeat accuracy:	< 1 %	
Temperature dependency:	< 0.1 %/°C (°F)	
Limit values tolerance:	5 % (10 % for 0.05 - 0.5 A and 0.1 - 10 A range)	
Hysteresis (fault to OK):	5 %	
<b>Output</b>		
Number of contacts:	1x changeover/SPDT (AgNi/Silver Alloy)	
Current rating:	8 A/AC1	
Breaking capacity:	2000 VA/AC1, 240 W/DC	
Output indication:	red LED	
<b>Other information</b>		
Operating temperature:	-20 °C to 55 °C (-4 °F to 131 °F)	
Storage temperature:	-30 °C to 70 °C (-22 °F to 158 °F)	
Dielectrical strength:	4 kV (supply - output)	
Operating position:	any	
Mounting:	DIN rail EN 60715	
Protection degree:	IP40 from front panel/IP10 terminals	
Overvoltage category:	III.	
Pollution degree:	2	
Max. cable size (mm <sup>2</sup> ):	solid wire max. 2x 2.5 or 1x 4, with sleeve max. 1x 2.5 or 2x 1.5 (AWG 12)	
Dimensions:	90 x 17.6 x 64 mm (3.5" x 0.7" x 2.5")	
Weight:	72 g (2.5 oz.)	
Standards:	EN 60255-1, EN 60255-26, EN 60255-27	

\* applicable also for current transformer

- It serves for monitoring of heating in rail-switches, heating cables, consumption of 1-phase motors, indicates current flow.
- Flexible adjustment by potentiometer
- Adjustable delay 0.5 - 10 s to eliminate short current peaks.
- It is possible to use for current scanning from current transformer.
- Supply is galvanically separated from measured current, it must be in the same phase.

### Description

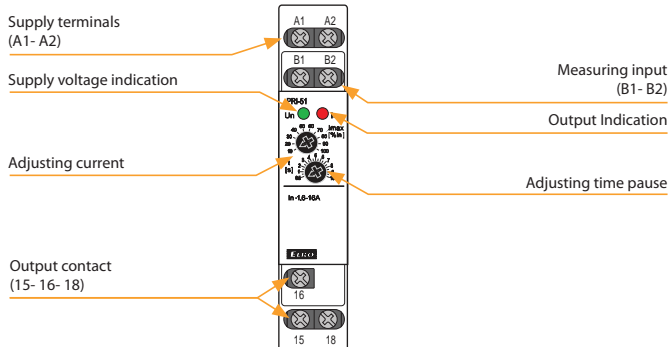

### Function

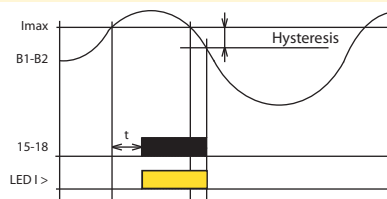

Monitoring relay PRI-51 serves to monitor current level in one-phase AC circuits. Gradual setting of actuating current of monitoring relay enables many different applications. Output relay is in normal state opened. After the set current level is reached, relay closes after the set delay (0.5 - 10 s). When returning from faulty to normal state there is a hysteresis (5 %). Multi-voltage of this relay is an advantage. It is possible to monitor load which doesn't have the same supply as monitoring relay PRI-51.

Range of PRI-51 can be increased by an external current transformer.

### Connection

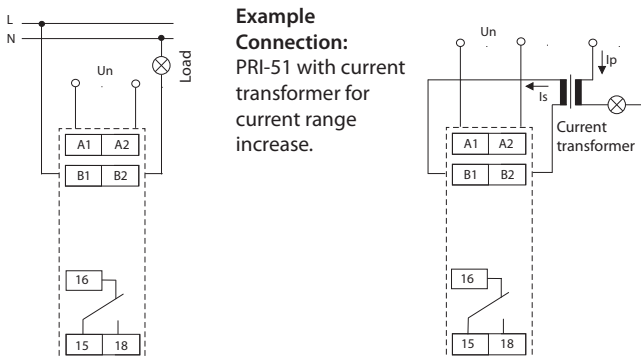

**Example Connection:** PRI-51 with current transformer for current range increase.

### Symbol

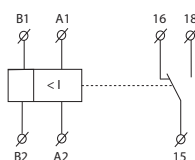

### Example of an order

Always specify all reference name of current relay according to required range, for example PRI-51/5.



EAN code  
PRI-52: 8595188136556

**Technical parameters** **PRI-52**

**Supply**

Supply terminals:	A1 - A2
Voltage range:	AC 230 V (50/60 Hz)
Power input (apparent/loss):	max. 5 VA/1.4 W
Max. dissipated power:	2.5 W (Un + terminals)
Supply voltage tolerance:	-15 %; +10 %

**Measuring circuit**

Current range:	AC 0.5 to 25 A (AC 50/60 Hz)
Maximal permanent current:	25 A
Inrush overload < 1s:	50 A
Current adjustment:	potentiometer
Time delay:	adjustable 0.5 to 10 s

**Accuracy**

Setting accuracy (mechanical):	10 %
Repeat accuracy:	< 1 %
Temperature dependence:	< 0.2 %/°C (°F)
Limit values tolerance:	10 %
Hysteresis:	0.25 A

**Output**

Number of contacts:	1x changeover/SPDT (AgNi/Silver Alloy)
Current rating:	8 A/AC1
Breaking capacity:	2000 VA/AC1, 240 W/DC
Output indication:	red LED

**Other information**

Operating temperature:	-20 to 55 °C (-4 °F to 131 °F)
Storage temperature:	-30 to 70 °C (-22 °F to 158 °F)
Dielectrical strength:	4 kV (supply - output)
Operating position:	any
Mounting:	DIN rail EN 60715
Protection degree:	IP40 from front panel/IP10 terminals
Overvoltage category:	III.
Pollution degree:	2
Max. cable size (mm <sup>2</sup> ):	max. 2x 2.5, max. 1x 4/ with sleeve max. 1x 2.5, max. 2x 1.5 (AWG 12)
Dimensions:	90 x 17.6 x 64 mm (3.5" x 0.7" x 2.5")
Weight:	65 g (2.3 oz.)
Standards:	EN 60255-1, EN 60255-26, EN 60255-27

**Connection**

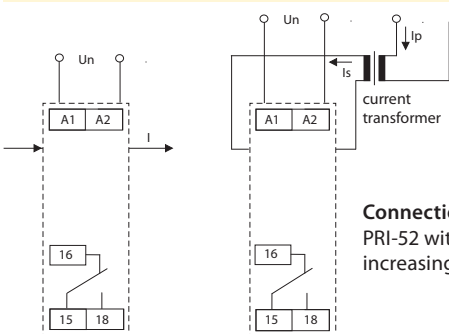

**Connection example:**  
PRI-52 with current transformer for increasing of current range.

- Relay is designated for:
  - cistant device diagnostic (short circuit, take-off increasing)
  - preferred (priority) relay - two appliances (boiler and floor heating) operating on one phase, but never run together - prevention against current overload and circuit breaker tripping. Enables to save your main breaker expenses
  - current tranzit indicator - informs about heating activation, ceramic hob, ventilator...
  - changing over of appliances according to inverter's (converter) output by photocell applications.
- Hole for threaded conductor passes through the body of device.
- part of device is current transformer, which is sensing size of current in threaded conductor.
- Possible to use also for sensing of current from external current transformer.
- Slight setting (by potentiometer) of tripping current - range AC 0.5 to 25 A.

**Description**

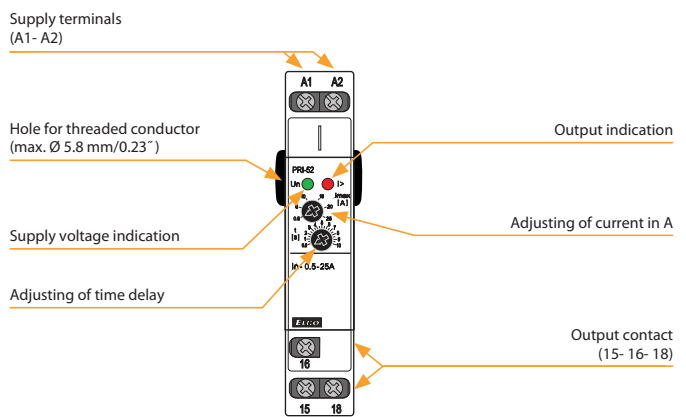

**Functions**

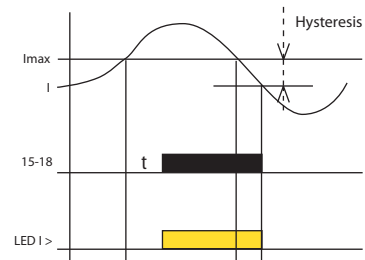

Monitoring relay PRI-52 serves for monitoring of current level in 1-phase AC circuits. Slight setting of release current level designates this relay for many various applications. Output relay is in normal status switched off. When set current level is overrun, relay get closed after preset delay. By return from error to normal status is used hysteresis.

PRI-52 range is possible to increase with external current transformer. Advantage of PRI-52 is that the hole for threaded conductor is located under the level of covering in the switchboard - thanks that, threaded conductor is not accessible for unwanted manipulation.

**Symbol**

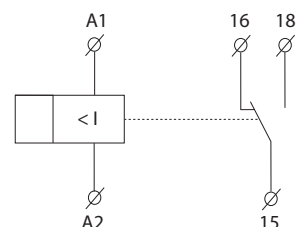



EAN code  
 PRI-53/1: 8595188142137  
 PRI-53/5: 8595188142144

Technical parameters	PRI-53/1	PRI-53/5
Supply terminals:	A1, A2	
Current monitoring terminals		
1st phase:	I1, I2	
2nd phase:	I3, I4	
3rd phase:	I5, I6	
Supply voltage:	24 - 240 V AC/DC	
Tolerance of voltage range:	± 10 %	
Operating AC frequency:	(45/65 Hz)	
Burden (max):	3 VA/1.2 W	
Max. dissipated power (Un + terminals):	2.5 W	
Rated current In:	AC 1 A	AC 5 A
Current level - I:	adjustable 40 - 120 % I <sub>n</sub>	
Overload capacity		
Continuous:	2 A	10 A
Max. 3s:	20 A	50 A
Difference:	fix 1 % I <sub>n</sub>	
Delay (until failure):	adjustable 0.5 - 10 s	
Output relay - contact:	2x changeover/SPDT (AgNi) gilded	
AC contact capacity:	250 V/8 A, max. 2000 VA	
DC contact capacity:	30 V/8 A	
Mechanical life:	3.000.000 at rated load	

Other information	
Operating temperature:	-20 °C to 55 °C (-4 °F to 131 °F)
Storing temperature:	-30 °C to 70 °C (-22 °F to 158 °F)
Dielectrical strength (power supply - relay contact):	4 kV/1 min.
Overvoltage category:	III.
Pollution level:	2
Protection degree:	IP40 from front panel/IP20 terminal
Max. cable size (mm <sup>2</sup> ):	max. 2x 1.5/1x 2.5 (AWG 12)
Dimensions:	90 x 105 x 64 mm (3.5" x 4.1" x 2.5")
Weight:	213 g (7.5 oz.)
Standards:	EN 60255-1, EN 60255-26, EN 60255-27

**Connection**

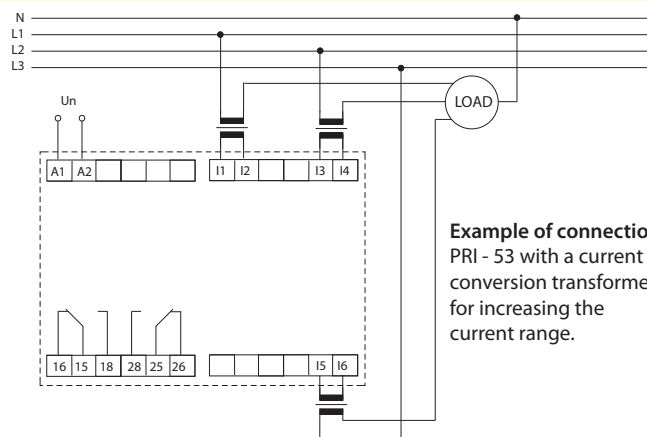

**Example of connection:** PRI - 53 with a current conversion transformer for increasing the current range.

- It is intended for monitoring the current in 3-phase devices (e.g. cranes, motors, etc.).
- 24 - 240 V AC/DC power supply, galvanically separated from the circuit of the monitored current.
- Adjustable delay level (when exceeding the preset limit).
- Adjustable function:
  - UNDER - monitors the drop in the strength of current below the pre-set value (I)
  - OVER - exceeding the preset value (I).
- 2 types depending on the strength of rated current I<sub>n</sub> (1 A, 5 A).
- Option of connecting via the current transformers to increase the value of the monitored current.

**Description**

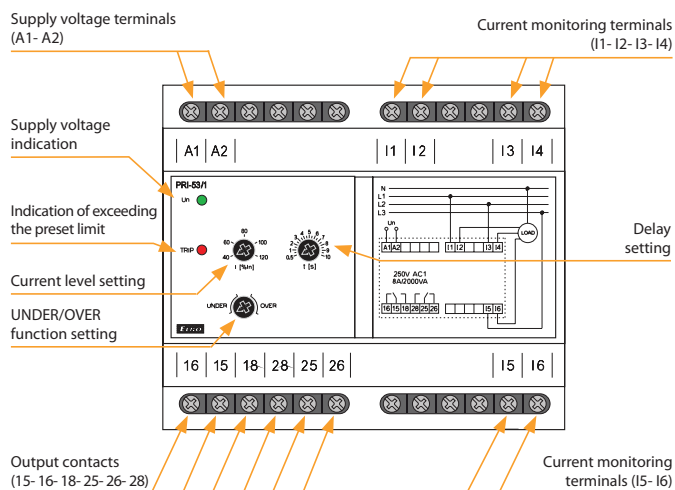

**Functions**

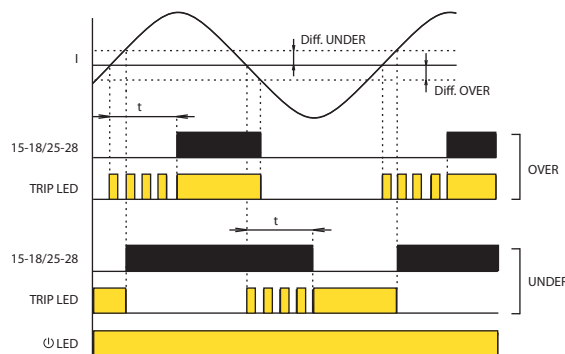

After the supply voltage is connected the green LED is on.

**UNDER function:**

If the strength of the monitored current in all phases exceeds the preset level I, the relay is triggered and the red LED is off. If the strength of the monitored current drops in any phase below the level I, the relay is disconnected after the preset delay timing elapses and the red LED goes on. The red LED flashes during the delay.

If the strength of the monitored current returns above the level I+difference, the relay is triggered without delay and the red LED goes off.

**OVER function:**

If the strength of the monitored current is lower in all phases than the preset level I, the relay is disconnected and the red LED is off.

If the strength of the monitored current exceeds in any phase the level I, the relay is triggered after the preset delay timing elapses and the red LED goes on. The red LED flashes during the delay.

If the strength of the monitored current again drops below the level I - difference, the relay is disconnected without delay and the red LED goes off.





EAN code  
 PRI-41/110V: 8595188140508  
 PRI-41/230V: 8595188140485  
 PRI-41/400V: 8595188147446  
 PRI-41/24V: 8595188140492  
 PRI-42/110V: 8595188140539  
 PRI-42/230V: 8595188140515  
 PRI-42/400V: 8595188147484  
 PRI-42/24V: 8595188140522

Technical parameters	PRI-41	PRI-42	
<b>Supply circuit</b>			
Supply terminals:	A1 - A2		
Voltage range:	AC 110 V, AC 230 V, AC 400 V or AC/DC 24 V (AC 50/60 Hz)		
Burden max.:	2.5 W/5 VA (AC 110 V, AC 230 V, AC 400 V), 1.4 W/2 VA (AC/DC 24 V)		
Max. dissipated power (Un + terminals):	5.5 W (110V, 230 V, 400 V) 4.5 W (24 V)		
Operating range:	-15 %; +10 %		
<b>Measuring circuit</b>			
Ranges:*	AC/DC 3.2 - 16 A (AC 50/60 Hz)	AC/DC 1 - 5 A (AC 50/60 Hz)	AC/DC 0.32 - 1.6 A (AC 50/60 Hz)
Terminals:	C - B1	C - B2	C - B3
Input resistance:	2.3 mΩ	11 mΩ	23 mΩ
Max. permanent current:	16 A	8 A	3 A
Inrush overload <1ms:	20 A	16 A	6 A
Time delay for I <sub>max</sub> :	adjustable 0.1-10 s		
Time delay for I <sub>min</sub> :	adjustable 0.1-10 s		
<b>Accuracy</b>			
Measuring accuracy:	5 %		
Repeat accuracy:	< 1 %		
Temperature dependency:	< 0.1 %/°C		
Limit values tolerance:	5 %		
Hysteresis (fault to OK):	selectable 5 %/10 % from range		
<b>Output</b>			
Number of contacts:	2x changeover/SPDT (AgNi/Silver Alloy)		
Current rating:	16 A/AC1		
Breaking capacity:	4000 VA/AC1, 384 W/DC		
Inrush current:	30 A/< 3 s		
Switching voltage:	250 V AC/24 V DC		
Output indication:	yellow LED		
Mechanical life:	30.000.000 operations		
Electrical life (AC1):	70.000 operations		
<b>Other information</b>			
Operating temperature:	-20 °C to 55 °C (-4 °F to 131 °F)		
Storage temperature:	-30 °C to 70 °C (-22 °F to 158 °F)		
Dielectrical strength:	4 kV (supply - output)		
Operating position:	any		
Mounting:	DIN rail EN 60715		
Protection degree:	IP40 from front panel/IP20 terminals		
Overvoltage category:	III.		
Pollution degree:	2		
Max. cable size (mm <sup>2</sup> ):	solid wire max. 1x 2.5 or 2x 1.5/ with sleeve max. 1x 1.5 (AWG 12)		
Dimensions:	90 x 52 x 65 mm (3.5" x 2" x 2.6")		
Weight:	248 g (8.7 oz.) (110 V, 230 V, 400 V); 145 g (5.1 oz.) (24 V)		
Standards:	EN 60255-1, EN 60255-26, EN 60255-27		

\* Only one of the inputs can be connected.

- Used to monitor overloading/relief (machine, motor, etc.), check consumption, diagnostics on a remote device (burning, short circuit, increased current draw, etc.)
- Relay designed for monitoring DC and AC currents in three ranges.
- the relay controls the current size in two independent levels (I<sub>max</sub>, I<sub>min</sub>).
- Setting the monitored level I<sub>max</sub> (in % of range).
- Setting the monitored level I<sub>min</sub>. (in % of range - for PRI-42 - function WINDOW), (in % of the set upper limit - for PRI-41 - function HYSTERESIS).
- Function of second relay (independently/in parallel).
- Adjustable delay for eliminating short-term outages and surges for every level independently.
- Galvanically separated power supply from monitoring inputs.
- Output contact: for each current level.

**Description**

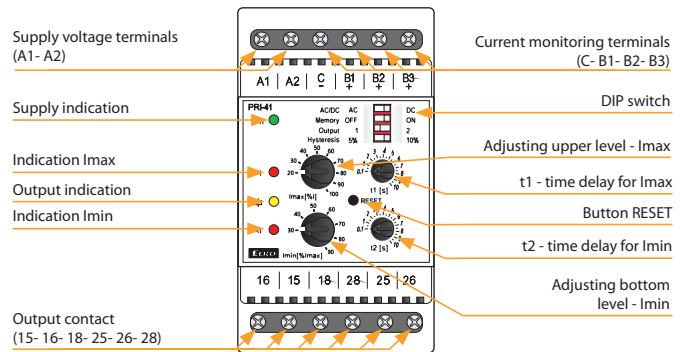

**Description and importance of DIP switches**

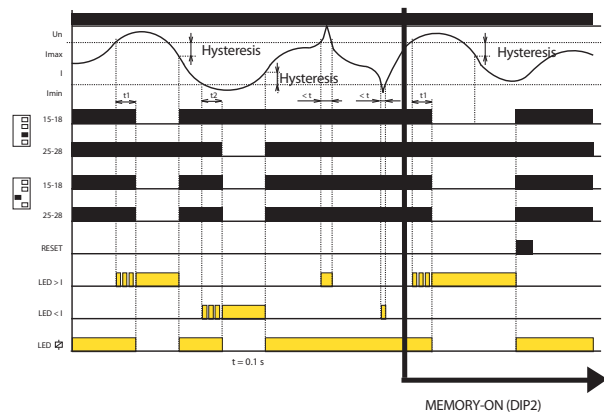
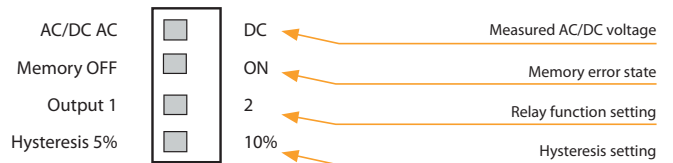

**Connection**

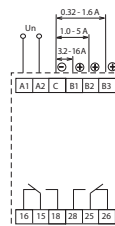

**Symbol**

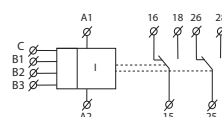

- If the value of the monitored current is in the zone between the set upper and lower levels, the status OK occurs - both relays are closed and the yellow LED illuminates. If the value of the monitored current is outside the set limits (> I<sub>max</sub> or < I<sub>min</sub>), an error state occurs.
- When moving to an error state I > I<sub>max</sub>, it times the delay t<sub>1</sub> and a red LED > I simultaneously flashes. After the t<sub>1</sub> time elapses, the red LED > I illuminates and the relevant relay opens.
- When moving to an error state I < I<sub>min</sub>, it times the delay t<sub>2</sub> and a red LED < I simultaneously flashes. After the time t<sub>2</sub> elapses, the red LED < I illuminates and the relevant relay opens.
- When moving from the error status to the OK status, the relevant red LED immediately goes out, and the corresponding relay closes.

**HRH-5**

Simple version, 2 functions, galvanically separated supply voltage UNI 24 to 240 V AC/DC. page 115

**HRH-7**

Suitable to operate in harsh conditions due to the high degree of protection IP65. Switch monitors the level changes in wells, reservoirs, tanks, tankers etc. page 116

**HRH-8**

8 functions, advanced setting for various combinations, galvanically separated supply AC 230 V or AC/DC 24 V, 2 output contacts/ 2PDT 16 A. page 118

**HRH-9**

The relay allows monitoring of up to 6 levels in one tank, while each probe has its own output contact, sensitivity range 10 - 470kΩ page 120

**HRH-6**

Device monitors 5 levels by using six probes. Supply voltage: 12-24 V DC or galvanically separated 230 V AC. page 122

**HRH-9/S****HRH-6/S**

Additional signalization to HRH-6 with 6 control lights on the front panel of device. page 122

## Level sets

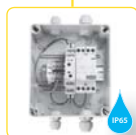
**HRH-4**

A set of level relay HRH-5 and a contactor VS425. For automatic operation 1-phase and 3-phase pumps. 2 function. IP55. page 124

**HRH-VS**

Level sets are used to monitor fluid levels. page 125

**HRH-MS-VS-4A**

Level sets are used to monitor fluid levels. page 125

## Accessories

**SHR**

Level sensors  
SHR-1(M, N) - for monitoring flooding.  
SHR-2- for level detection.  
SHR-3 - for demanding and industrial environment. page 126

**Cable, wire**

D03VV-F 3x0,75/3,2 - cable to SHR-1 and SHR-2 probes.  
D05V-K 0,75/3,2 - wire to SHR-1 and SHR-2 probes. page 127

Type	Design	Supply voltage	Secure variables		Nastavení			Description	Strana
			Level max.	Level min.	Delay	Sensitivity Probe	Function		
HRH-5	1-M	AC/DC 24-240 V	●	●	●	●	●	Measuring the frequency of 10 Hz will protect liquid from polarisation and measuring probes from increased oxidation. Galv. separated power supply.	115
HRH-7	IP65 BOX	AC/DC 24-240 V	●	●	●	●	●	Suitable to work in harsh conditions due to the high degree of protection IP65.	116
HRH-8/230 V HRH-8/110 V HRH-8/400 V HRH-8/24 V	3-M	AC 230 V AC 110 V AC 400 V AC/DC 24 V	●	●	●	●	●	Sensitivity adjustable by potentiometer. Galvanically separated power supply	118
HRH-9	6-M	AC/DC 24-240 V	●	●	●	●	●	It monitors up to 6 level levels, each with its own output contact. Optional filling/draining function for each probe separately incl. delay options. Sensitivity can be set automatically or manually.	120
HRH-6/AC HRH-6/DC	IP65 BOX	AC 230 V AC/DC 12-24V	●	●*	●	●	●	* Devices mainly designated for monitoring water level in fire-engine tanks	122
HRH-4/230 V HRH-4/24 V	IP65 BOX	AC 230 V AC/DC 24 V	●	●	●	●	●	Unit with no protection devices - adequate protection element needs to be integrated before the unit. Ingress protection of the assembly is IP65	124
HRH-VS	IP65 BOX	230/400V AC	●	●	●	●	●	Level sets placed in the control cabinet with IP65 protection (protected against dust and spraying water) where everything is already connected	125
HRH-MS-VS-4 A	IP65 BOX	230/400V AC	●	●	●	●	●		



EAN code  
HRH-5: 8595188136396

Technical parameters		HRH-5
Functions:	2	
Supply terminals:	A1 - A2	
Voltage range:	24 to 240 V AC/DC (AC 50/60 Hz)	
Input:	max. 2 VA/1.5 W	
Max. dissipated power (Un + terminals):	2 W	
Toleration of voltage range:	-15 %; +10 %	
Measuring circuit		
Sensitivity (input resistance):	adjustable in range 5 kΩ - 100 kΩ	
Voltage n electrodes:	max. AC 3.5 V	
Current in probes:	AC < 0.1 mA	
Time response:	max. 400 ms	
Max. capacity of probe cable:*	800 nF (sensitivity 5 kΩ), 100 nF (sensitivity 100 kΩ)	
Time delay (t):	adjustable, 0.5 -10 sec	
Time delay after switching on (t1):	1.5 sec	
Accuracy		
Accuracy in setting (mech.):	± 5 %	
Output		
Number of contacts:	1x changeover/SPDT (AgNi/Silver Alloy)	
Current rating:	8 A/AC1	
Switching voltage:	2000 VA/AC1, 240 W/DC	
Switched voltage:	250 V AC/24 V DC	
Mechanical life (AC1):	10.000.000 operations	
Electrical life:	100.000 operations	
Other information		
Operational temperature:	-20 °C to 55 °C (-4 °F to 131 °F)	
Storing temperature:	-30 °C to 70 °C (-22 °F to 158 °F)	
Dielectrical strenght:	2.5 kV (supply - sensors)	
Operational position:	any	
Mounting:	DIN rail EN 60715	
Protection degree:	IP40 from font panel/IP10 terminals	
Overvltage category:	II.	
Pollution degree:	2	
Profile of connecting wires (mm <sup>2</sup> ):	max. 2x 2.5, max. 1x 4/ with sleeve max. 1x 2.5, max. 2x 1.5 (AWG 12)	
Dimensions:	90 x 17.6 x 64 mm (3.5" x 0.7" x 2.5")	
Weight:	73 g (2.6 oz.)	
Standards:	EN 60255-1, EN 60255-26, EN 60255-27, EN 60669-1, EN 60669-2-1	
Recommended measuring probes:	see pg. 126	

\* Max. line length is limited by the capacity between the individual cable cores.

Symbol

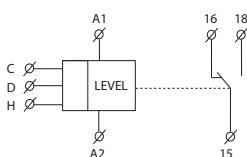

- Relay is designed for monitoring levels in wells, basins, reservoirs, tanks,...
- In one device you can choose the following configurations:
  - One-level switch of conductive liquids (by connecting H and D).
  - Two-level switch of conductive liquids.
- One-state device monitors one level, two-state device monitors two levels (switches on one level and switches off on another level).
- Adjustable time delay on the output (0.5 - 10s).
- Sensitivity adjustable by a potentiometer (5 - 100 kΩ).
- Measuring frequency 10 Hz prevents polarization of liquid and raising oxidation of measuring probes.
- Galvanically separated supply voltage UNI 24 to 240 V AC/DC.

Device description

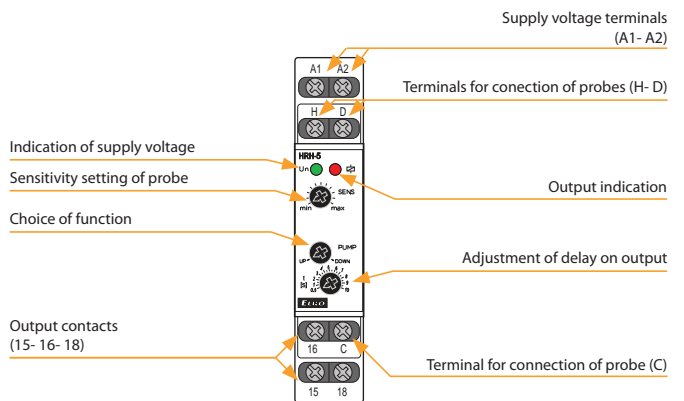

Function

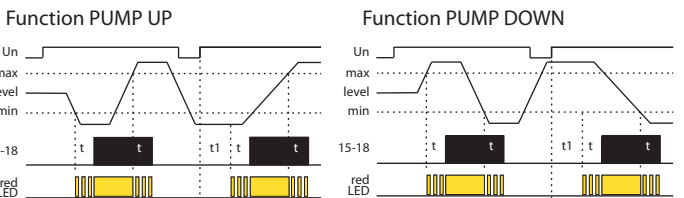

Relay is designated for monitoring of levels of conductive liquids with possibility of functions: PUMP UP or PUMP DOWN. To prevent polarization and liquid electrolysis of liquid, and undesirable oxidation of measuring probes, alternating current is used. For measuring use three measuring probes: H- upper level, D- lower level, C - common probe. In case you use a tank made of a conductive material, you can use it as probe C. In case you require monitoring of one level only, it is necessary to connect inputs H and D and connect them to one probe - in this case sensitivity is lowered by half (2.5 to 50 kΩ). Probe C can be connected with a protective wire of supply system (PE). To prevent undesirable switching out output contacts by various influences (sediment on probes, humidity,...) it is possible to set sensitivity of the device according to conductivity of monitored liquid (corresponding to "resistance" of liquid) range 5 up to 100 kΩ. To reduce influences of undesirable switching of output contacts by liquid gorgle in tanks, it is possible to set delay of output reaction 0.5 - 10 s.

Connection

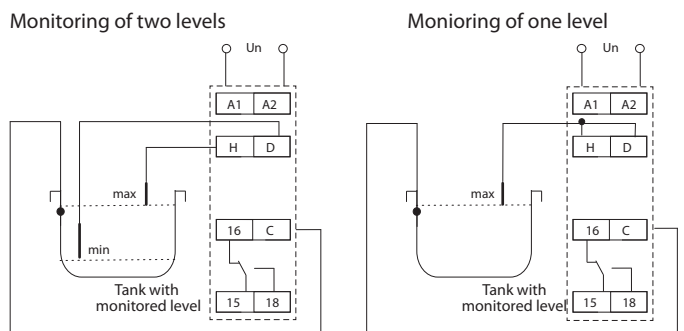



EAN code  
HRH-7: 8595188149471

Technical parameters	HRH-7
Function:	2
Supply terminals:	A1 - A2
Supply voltage:	24 to 240 V AC/DC (AC 50/60 Hz)
Burden:	max. 2 VA/1.5 W
Max. dissipated power (Un + terminals):	3 W
Supply voltage tolerance:	-15 %; +10 %
Max. value of overcharge protection:	16 A
<b>Measuring circuit</b>	
Sensitivity (input resistance):	adjustable from 5 kΩ - 100 kΩ
Voltage on electrodes:	max. AC 3.5 V
Current on probes:	AC < 0.1 mA
Time response:	max. 400 ms
Max. capacity of probe cable:	800 nF (sensitivity 5kΩ), 100 nF (sensitivity 100 kΩ)
Time delay (t):	adjustable, 0.5 -10 sec
Time delay (t1):	1.5 sec
<b>Accuracy</b>	
Setting accuracy (mechanical):	± 5 %
<b>Output</b>	
Number of contacts:	1x changeover/DPDT (AgSnO <sub>2</sub> )
Current rating:	16 A/AC1
contact NO:	15-18: 6 A/AC3
contact NC:	15-16: 3 A/AC3
Switching capacity:	4000 VA/AC1, 384 W/DC
Switching voltage:	250 V AC/24 V DC
Mechanical life:	30.000.000 operations
Electrical life (AC1):	70.000 operations
<b>Other information</b>	
Operating temperature:	-20 °C to 55 °C (-4 °F to 131 °F)
Storage temperature:	-30 °C to 70 °C (-22 °F to 158 °F)
Dielectrical strength:	3.75 kV (supply - sensor)
Operating position:	any
Protection:	IP65
Overvoltage category:	III.
Contamination degree:	2
Cable size (mm <sup>2</sup> ):	max. 2x 2.5/ with sleeve max. 2x 1.5 (AWG 12)
Dimension:	139 x 139 x 56 mm (5.5" x 5.5" x 2.2")
Weight:	241 g (8.5 oz.)
Related standards:	EN 60255-1, EN 60255-26, EN 60255-27, EN 60669-1, EN 60669-2-1
Recommended measuring probes:	see pg. 126

### Symbol

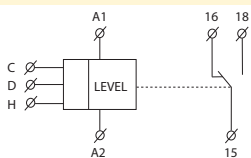

- Suitable to operate/work in harsh conditions due to the high degree of protection IP65.
- Switch monitors the level changes in wells, reservoirs, tanks, tankers etc.
- It is possible to select the following configurations:
  - One-level switch of conductive liquids monitors one level (by connecting H and D).
  - Two-level switch of conductive liquids monitors two levels (switches on at one level and switched off at another level).
- Adjustable time delay of output (0.5 - 10 s).
- Adjustable sensitivity using potentiometer (5 -100 kΩ).
- Measuring frequency 10 Hz prevents liquid polarization and increased oxidation of measuring probes.
- Measuring circuits are galvanically separated from the power source of the product and circuits of the relay contact by enhanced insulation according to EN 60664-1 for overvoltage category III.

### Device description

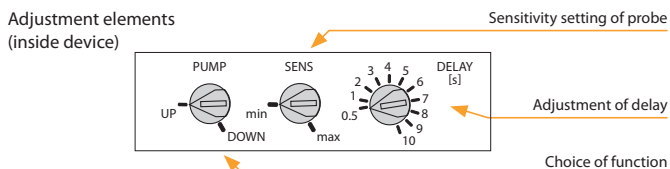
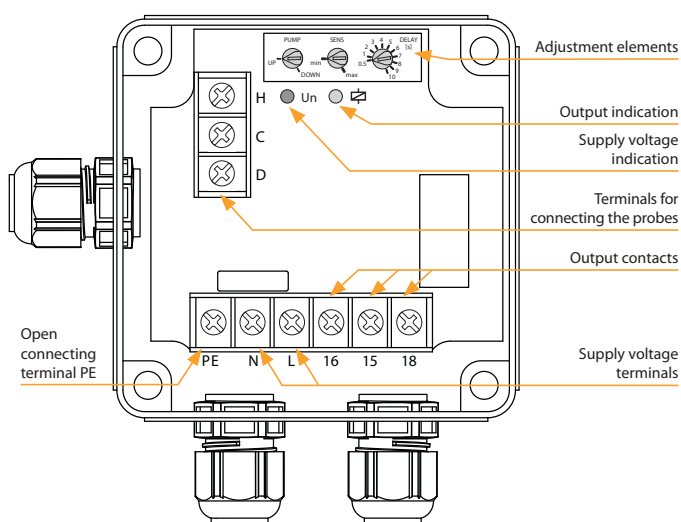

### Connection

connection for power supply 230 V AC

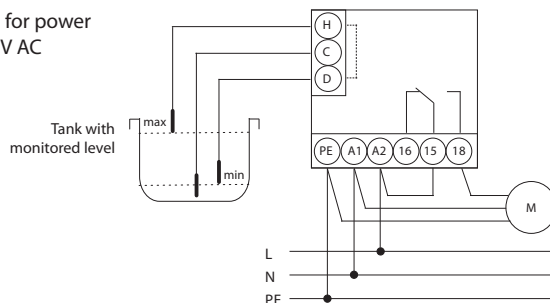

connection for power supply 24 to 240 V AC/DC

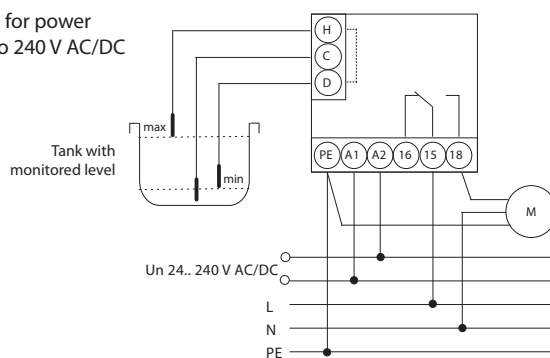

Function



An AC current is used for measuring to prevent polarization and electrolysis of fluid and unwanted oxidation of measuring probes. Three probes are used for measuring: H - upper level, D - lower level and C - common probe. If using a tank made from conductive material, it is possible to use the tank itself as probe C.

If it is necessary to monitor only one level, there are two connection options:

1. Inputs H and D are connected to a single probe - in this case the sensitivity is decreased to half (2.5 to 50 kΩ).
2. Inputs H and C are connected and the probe is connected to input D - in this case, the original sensitivity remains (5 to 100 kΩ).

It is also possible to connect probe C with a protective conductor of the power system (PE).

Example of connecting the level switch to a 1-phase pump at a well, borehole

wiring for supply 230 V AC (for monitoring two levels)

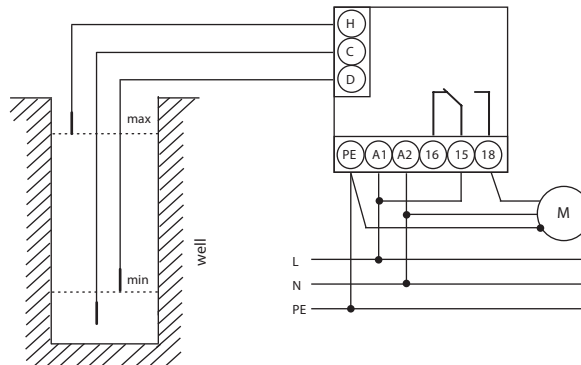

Monitoring TWO LEVELS of the FLUID LEVEL minimum/maximum - DRAINING function - (PUMP DOWN)

Description of draining function:

This function is used in a well or borehole, where the difference between the upper and lower probes determines, how much water the pump can pump out and protect against running dry.

After detecting the maximum level, the set reaction delay begins running. After this period, the output contact immediately switches on the pump, until the minimum level is reached, when the set delay begins running once again. The pump then switches off.

Monitoring TWO LEVELS minimum/maximum - REPLENISHING function - (PUMP UP)

Description of replenishing function:

This function is used when you need to regularly pump in water to a well or borehole, which is leaking.

After detecting the minimum level, the set reaction delay begins running. After this period, the output contact immediately switches on the pump for the period, until it reaches the maximum level, where the set delay begins running once again. The pump then switches off.

Example of connecting the level switch to a 3-phase pump at the well, borehole

wiring for supply 230 V AC (for monitoring two levels)

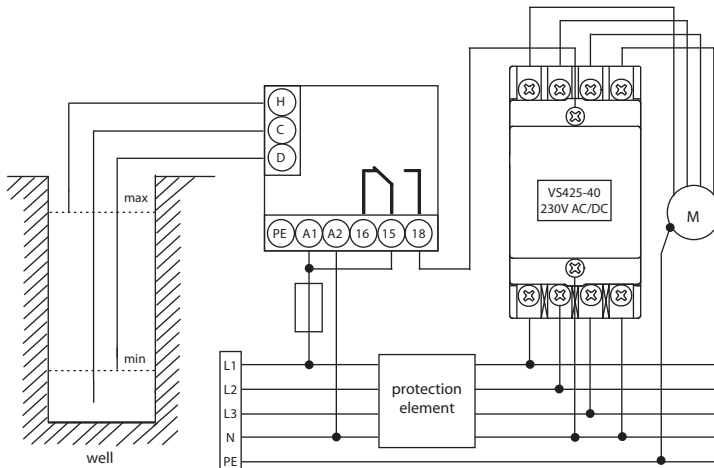

Monitoring TWO LEVELS minimum/maximum - DRAINING function - (PUMP DOWN)

Description of draining function:

The function is used to protect against overflows and flooding of areas. After detecting the maximum level, the set reaction delay begins running. After this period, the output contact immediately switches on the 3-phase pump, until the minimum level is reached, when the set delay begins running once again. The pump then switches off.



EAN code  
 HRH-8/110V: 8595188156387  
 HRH-8/230V: 8595188155427  
 HRH-8/24V: 8595188155564  
 HRH-8/400V: 8595188171199

Technical parameters		HRH-8
Function:	8	
Supply terminals:	A1 - A2	
Voltage range:	AC 110 V, AC 230 V, AC 400 V or AC/DC 24V galvanically separated (AC 50/60Hz)	
Burden max.:	2.5 W/5 VA (AC 230 V, AC 110 V, AC 400 V), 1.4 W/2 VA (AC/DC 24 V)	
Max. dissipated power (Un + terminals):	4 W (110 V, 230 V, 400 V); 3 W (24 V)	
Supply voltage tolerance:	-15 %; +10 %	
Measuring circuit		
Hysteresis (input - opening):	in an adjustable range 5 kΩ - 100 kΩ	
Voltage on electrode:	max. AC 3.5 V	
Current in probes:	AC < 1 mA	
Time reaction:	max. 400 ms	
Max. cable capacity:	800 nF (sensitivity 5kΩ), 100 nF (sensitivity 100 kΩ)	
Time delay t:	adjustable 0.5 - 10 sec	
Accuracy		
Setting accuracy (mech.):	± 5 %	
Output		
Number of contacts:	2x changeover/SPDT (AgNi/Silver Alloy)	
Current rating:	16 A/AC1	
Breaking capacity:	4000 VA/AC1, 384 W/DC	
Inrush current:	30 A/< 3 s	
Switching voltage:	250 V AC/24 V DC	
Output indication:	red LED	
Mechanical life:	30.000.000 operations	
Electrical life (AC1):	70.000 operations	
Other information		
Operating temperature:	-20 °C to 55 °C (-4 °F to 131 °F)	
Storage temperature:	-30 °C to 70 °C (-22 °F to 158 °F)	
Dielectrical strength:	4 kV (supply - output)	
Operating position:	any	
Mounting:	DIN rail EN 60715	
Protection degree:	IP40 from front panel/IP20 terminals	
Overvoltage category:	III.	
Pollution degree:	2	
Max. cable size (mm <sup>2</sup> ):	solid wire max. 1x 2.5 or 2x1.5/with cavern max. 1x 1.5 (AWG 12)	
Dimensions:	90 x 52 x 65 mm (3.5" x 2" x 2.6")	
Weight:	247 g/8.7 oz (110 V, 230 V, 400 V); 145 g/5.1 oz (24 V)	
Standards:	EN 60255-1, EN 60255-26, EN 60255-27, EN 60669-1, EN 60669-2-1	
Measuring sensors:	see pg. 126	

### Measuring probes

There can be any measuring probe (any conductive contact, it is recommended to use brass or stainless steel).  
 The probe wire does not need to be shielded, but it is recommended.  
 When using a shielded wire, the shielding is connected to terminal S.

- Relay is designed to control the level of conductive liquids in wells, tanks, pools, tankers, reservoirs,... (replacement HRH-1).
- Galvanically isolated supply and guard circuits.
- Within one device, the following configurations can be selected:
  - 2x one-level monitoring (in separate tanks)
  - 1x two-level monitoring (in one tank)
  - pumping from one tank to another.
- DIP switch selection on the front panel (8 functions).
- Adjustable probe sensitivity (for each probe separately).
- Adjustable relay switching delay (for each probe separately).
- 10 Hz watch frequency prevents polarization of the liquid and increases resistance to interference by network frequency.

### Description

HRH-8/24V

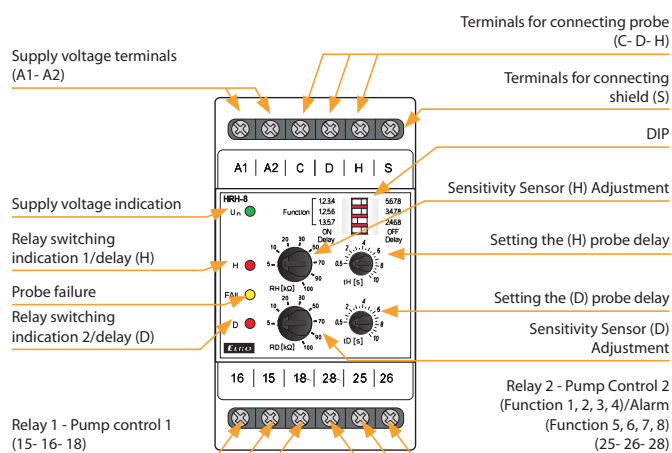

### Description and importance of DIP switches

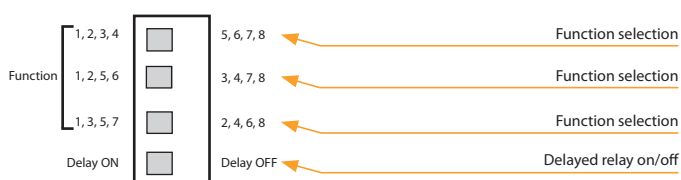

### Connection

HRH-8 (110V, 230V, 400V)

HRH-8/24V

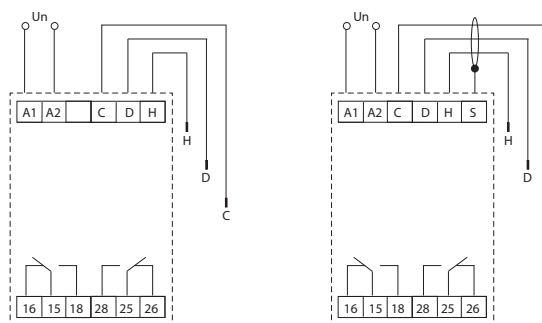

### Symbol

HRH-8 (110V, 230V, 400V)

HRH-8/24V

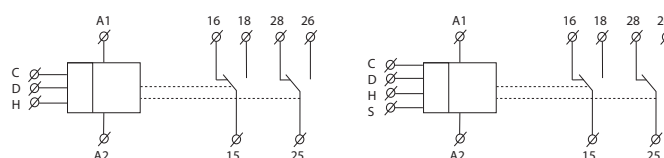

Functions

PUMP UP, ON DELAY (Function 1,3,4)

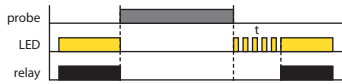

PUMP DOWN, ON DELAY (Function 2,3,4)

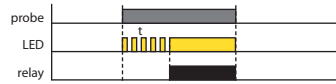

PUMP UP, OFF DELAY (Function 1,3,4)

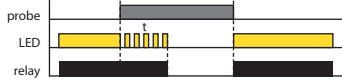

PUMP DOWN, OFF DELAY (Function 2,3,4)



PUMP UP, OFF DELAY (Function 5)

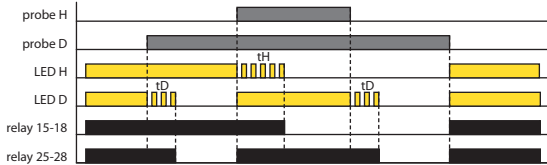

PUMP UP, ON DELAY (Function 5)

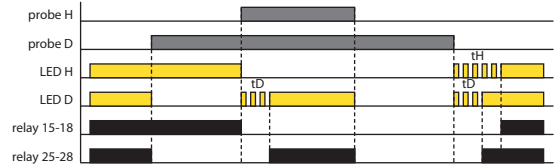

PUMP DOWN, OFF DELAY (Function 6)

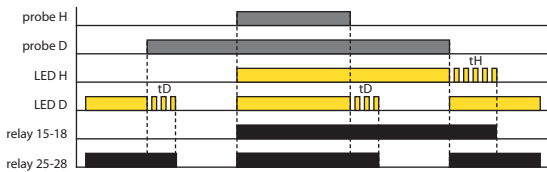

PUMP DOWN, ON DELAY (Function 6)

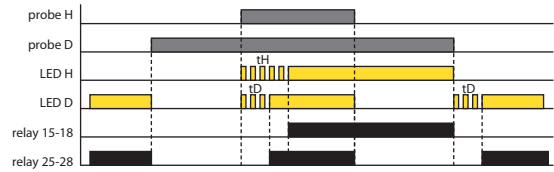

WELL - TANK, OFF DELAY (Function 7)

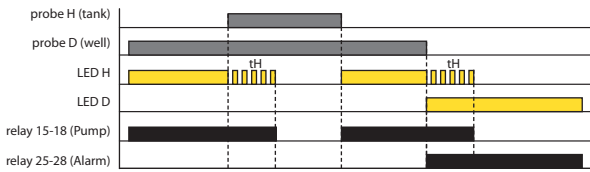

WELL - TANK, ON DELAY (Function 7)

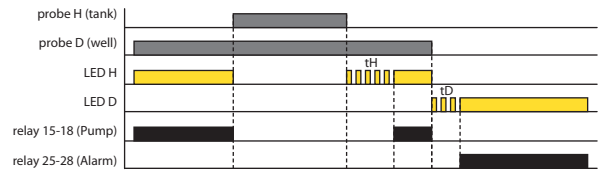

RESERVOIRS - TANK, OFF DELAY (Function 8)

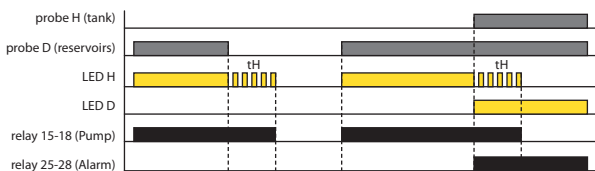

RESERVOIRS - TANK, ON DELAY (Function 8)

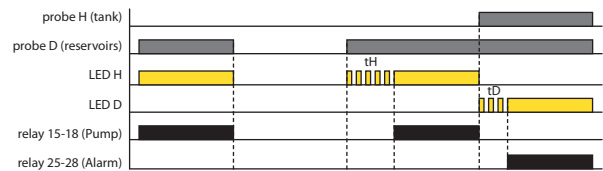

The relay is designed to monitor the level of conductive liquids with a choice of 8 functions:

- 1) - 2 separate tanks (each with 1 probe) - both PUMP UP (filling)
- 2) - 2 separate tanks (each with 1 probe) - both PUMP DOWN (emptying)
- 3) - 2 separate tanks (each with 1 probe) - H PUMP DOWN probe, D PUMP UP probe
- 4) - 2 separate tanks (each with 1 probe) - H PUMP UP probe, probe D PUMP DOWN
- 5) - both probes in one tank - PUMP UP - maintain level between probes H and D (as HRH-5), relay 1 switches on the pump, relay 2 alarm (level is not between probes H and D)
- 6) - Both probes in one tank - PUMP DOWN - maintaining the level between probes H and D (as HRH-5), relay 1 switches on the pump, relay 2 alarm (the level is not between probes H and D)
- 7) - Pumping from the well to the tank - probe D in the well, probe H in the tank. The pump only runs if the probe D is flooded (enough water in the well) and the tank is not full (probe H). The alarm reports a lack of water in the well (probe D is not flooded).
- 8) - Pumping from the sump to the tank - probe D in the sump, probe H in the tank. The pump only runs if the probe D is flooded (full tank) and the tank is not full (probe H). The alarm reports the status of full tank and sump (both probes are flooded).

LED indication:

The red LED lights up - the corresponding relay is switched on  
Red LED flashes - delay timing

The yellow LED indicates probe failure - Functions 5, 6 probe H is flooded and probe D is not. At the same time both red LEDs flash.

To prevent polarization and electrolysis of the liquid and undesirable oxidation of the monitoring probes, an AC current of 10 Hz is used for monitoring. The low frequency has a positive effect on suppression of interference by 50 (60) Hz. Three probes are used to monitor the level: H - upper level, D - lower level and C - common probe. In the case of the use of a conductive material tank, it is possible to use the tank itself as a C probe. Probe C can also be connected to the protective conductor of the power supply system (PE). To prevent undesired switching by various influences (soiling of dips, moisture ...), the sensitivity of the device can be set according to the conductivity of the liquid being monitored (corresponding to the "resistance" of the liquid) in the range of 5 to 100 kΩ. To limit the effect of undesired switching of output contacts by raising the liquid level in the tank, it is possible to set the output response delay 0.5 - 10 s.

NEW



EAN code  
HRH-9: 8595188181334  
HRH-9/S: 8595188181853

### Technical parameters

HRH-9

#### Supply

Supply terminals:	A1 - A2
Supply voltage:	AC/DC 24 to 240V (AC 50/60Hz)
Supply voltage tolerance:	-15% +10%
galvanically separated voltage:	yes
Burden max.:	2W, 4VA
Max. dissipated power (Un + terminals):	10 W
Power indication:	green LED

#### Measuring circuit

Number of level probes:	6 + 1 common
Adjustable probe function:	PUMP UP, PUMP DOWN, ON, OFF
Voltage on probes:	5V AC max./10Hz
Time reaction in probes:	1,1s
Time delay (PROBE DELAY):	adjustable 0.5 - 10s
Max. capacity of probe cable:	16nF (sensitivity 470 kΩ), 500nF (sensitivity 9,1 kΩ)
Probe sensitivity calibration range:	10kΩ to 470kΩ
Sensitivity range of probes manually (for probes 4, 5, 6):	50kΩ to 470 kΩ
Time delay (START DELAY):	adjustable 0 to 30min
Probe status indication:	red LED + external LED

#### Output

Number of contacts:	6x switching (AgSnO <sub>2</sub> )
Current rating:	10A (AC1)
Switching voltage max.:	250V AC
Breaking capacity max.:	2500VA
Mechanical life:	10.000.000 operations
Electrical life (AC1):	100.000 operations

#### Other information

Operating temperature:	
Storage temperature:	-20 to +55°C (-4 to 131 °F)
Dielectrical strength:	-30 to +70°C (-22 to 158 °F)
power supply - probes	AC 4kV
power supply - relay contacts	AC 4kV
contacts of adjacent relays	AC 4kV
Operating position:	any
Mounting:	DIN rail EN 60715
Protection degree:	IP40 from front panel/IP20 terminals
Overvoltage category:	III.
Pollution degree:	2
Max. cable size (mm <sup>2</sup> )	
probes/power supply/signaling:	solid wire max. 1x 2.5 or 2x1.5/with cavern max. 1x 1.5 (AWG 12)
output part:	solid wire max. 1x 2.5 or 2x1.5/with cavern max. 1x 1.5 (AWG 12)
Dimensions:	90 x 105 x 65mm (3.5" x 4.1" x 2.6")
Weight:	252 g (8.9 oz.)
Standards:	EN 60255-1, EN 60255-26, EN 60255-27, EN 60669-1, EN 60669-2-1

- The relay is designed to control the level of conductive liquids in wells, sumps, tanks, pools, tankers, reservoirs ...
- Galvanically separated power and monitoring circuits.
- Possibility to connect up to 6 level probes (+ one common probe).
- Each probe has its own output relay function selection for each probe separately.
- Adjustable delay after power on (START Delay).
- Adjustable relay closing delay (Probe Delay) - common for all probes.
- Automatic calibration of the sensitivity of the probes according to the conductivity of the monitored liquid.
- For probes 4, 5, 6 possibility of manual sensitivity adjustment.
- A monitoring frequency of 10 Hz prevents polarization of the liquid and increases the resistance to mains frequency interference.

### Description

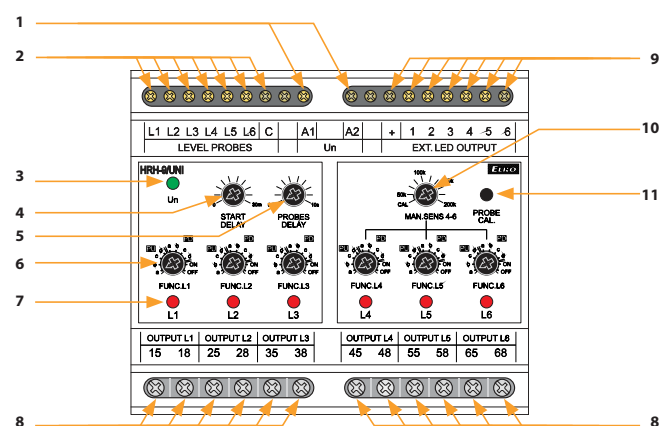

- |                                    |   |
|------------------------------------|---|
| 1 Supply voltage terminals         | 7 Probe status indication (L1)                        |
| 2 Terminals for probes connection  | 8 Probe output contact (L1)                           |
| 3 Supply voltage indication        | 9 Terminals for connecting external signaling HRH-9/S |
| 4 Setting delay after switching on | 10 Manual adjustment of probe sensitivity L4,L5, L6   |
| 5 Delay setting relay closing      | 11 Calibration button of connected probes             |
| 6 Probe function setting (L1)      |   |

### Function

HRH-9/S

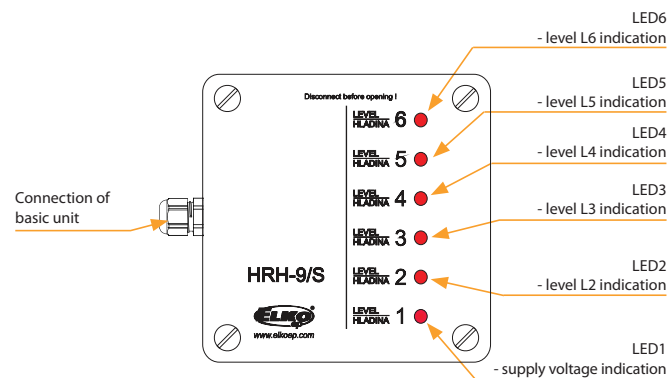



## Function

Green LED Un:

- Flashes for START DELAY after the power is turned on
- During this time the device does not respond to the state of the level probes

- After START DELAY, the green LED lights up permanently

START DELAY control:

- sets the START DELAY, delay in the range 0 to 30 minutes

Level probe function switch FUNC. L1 (L2 to L6):

A total of 6 level probes L1 to L6 + common probe C can be connected to the device. Each probe has its own function switch, which sets the functions PUMP UP, PUMP DOWN, ON - permanently

Relay closed, OFF - permanently open relay.

- Positions 1 - 4 = PUMP UP

- Positions 5 - 8 = PUMP DOWN

- Position 9 = ON (relay permanently closed, red LED lit)

- Position 10 = OFF (relay open, red LED not lit)

Each of the PUMP UP, PUMP DOWN functions has 4 response delay setting options:

a - function without delay

b - ON DELAY - delayed closing of the relay

c - OFF DELAY - delayed opening of the relay

d - ON/OFF DELAY - delayed closing and opening of the relay

Each probe then controls its output relay depending on the function switch setting. If a probe is not used, its switch must be set to OFF or ON. PROBES DELAY control:

- sets the delay of the relay response to the change of the state of the level probes

- Delay is standard for all probes - range 0.5 to 10s

LED indication of the status of probes L1 to L6:

Each probe has its own red LED, indicating the status of the probe + output for external LED additional signalling, which copies the status of the internal red LED:

- Probe is not immersed - the red LED is off

- Probe is immersed, the delay is not running - the red LED is lit.

- Probe has just been immersed and the delay is running - red LED flashes (shorter pulse)

- Probe has just surfaced and a delay is running - red LED flashes (longer pulse)

- Calibration error - red LED flashes quickly

## Wiring example

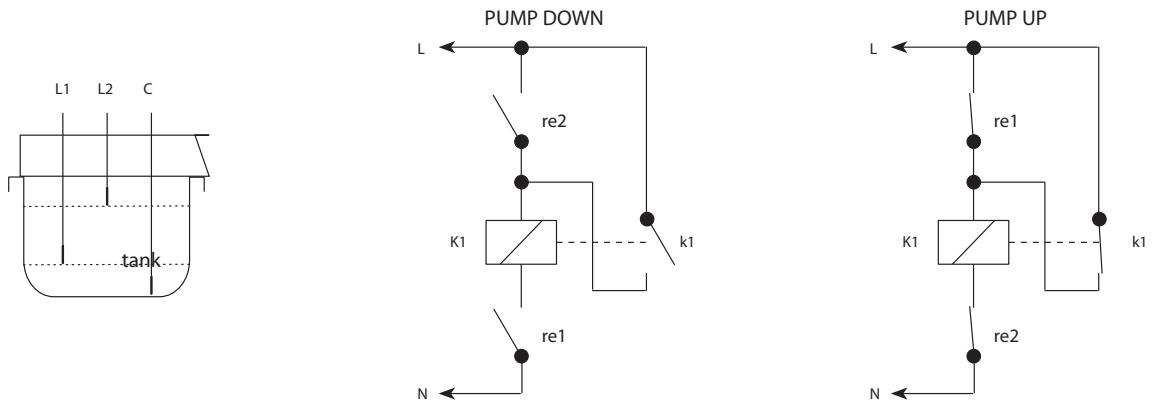

Level probes in the tank:

- the common probe C is positioned so that it is always immersed
- the position of the L1 probe determines the lower level, the position of the L2 probe determines the upper level
- the connection is used to maintain the level between the L1 and L2 probes

Description of the PUMP DOWN function:

- if the tank is empty, both probes L1 and L2 are not immersed, both relays re1 and re2 are open. Contactor K1 controlling the pump is also open (pump stopped)
- if the tank is filled, after reaching the L1 level the relay re1 closes and the state does not change further
- after reaching the level L2 the relay re2 closes and at the same time the contactor K1 closes (the pump works)
- when the level drops below L2, relay re2 opens, but the contactor remains closed via its switching contact k1
- when the level drops below L1, relay re1 opens and at the same time contactor K1 opens (pump stops)

Description of the PUMP UP function:

- if the tank is empty, both probes L1 and L2 are not immersed, both relays re1 and re2 are closed. Contactor K1 controlling the pump is closed (pump is running)
- if the tank is filled, after reaching the level L1 the relay re1 opens - the state does not change - the contactor remains closed via its switching contact k1
- after reaching the level L2, the relay re2 opens and at the same time the contactor K1 (the pump stops)
- when the level drops below L2, relay re2 closes and the state does not change further
- when the level drops below L1, relay re1 closes and at the same time contactor K1 closes (pump starts)

## Connection with additional signalization HRH-9/S

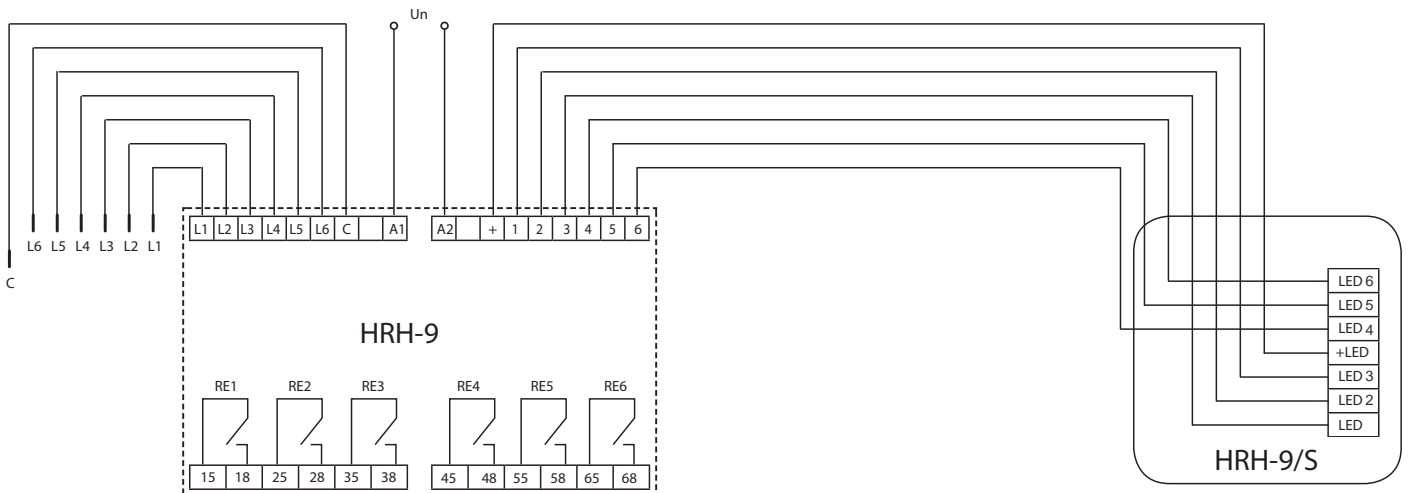



EAN code  
HRH-6/AC: 8595188136990  
HRH-6/DC: 8595188137409

Technical parameters	HRH-6/DC	HRH-6/AC
Function:	2	
Voltage range:	12 to 24 V DC	230 V AC (50/60 Hz)
Burden:	max. 1.8 W	max. 3.8 VA
Max. dissipated power ( $U_n$ + terminals):	3 W	
Supply tolerance:	$\pm 20\%$	-20 %; +10 %
<b>Measuring circuit</b>		
Sensitivity adjustable in the range*:	min. 10 k $\Omega$ max. 200 k $\Omega$	
Voltage on probes:	max. 3 V AC	
Probe cable maximum capacity:	500 nF (for min. sensitivity), 50 nF (for maximum sensitivity)	
Time delay:	adjustable 1 to 10 s	
<b>Output</b>		
Number of contacts:	6x LED (1x red, 1x yellow, 4x green)	
Current rating:	10 A/AC1	
Switching voltage:	2500 VA/AC1, 200 W/DC	
Peak current:	16 A/< 3 s	
Switching voltage:	250 V AC/24 V DC	
Mechanical life (AC1):	30.000.000 operations	
Electrical life:	70.000 operations	
<b>Other information</b>		
Operating temperature:	-20 °C to 55 °C (-4 °F to 131 °F)	
Storage temperature:	-30 °C to 70 °C (-22 °F to 158 °F)	
Diel. strength (supply - probes):	x	3.75 kV
Operating position:	IP65	
Protection degree:	x	III.
Overvoltage category:	2	
Pollution degree:	110 x 130 x 72 mm (4.3" x 5.1" x 2.8")	
Dimensions:	288 g (10.2 oz.)	385 g (13.6 oz.)
Weight:	EN 60255-1, EN 60255-26, EN 60255-27,	
Standards:	EN 60669-1, EN 60669-2-1	
Recommended measuring probe:	see pg. 126	

\* Note: sensitivity is higher at both ends of a range of values.

## Connection

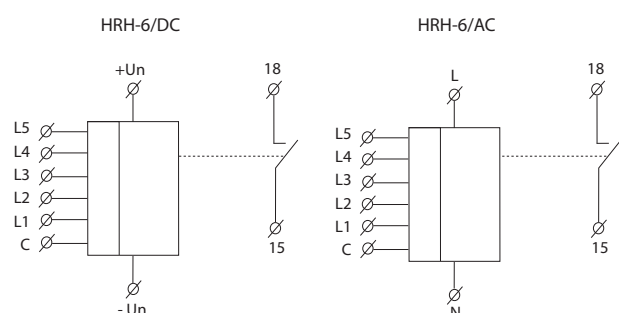

- Function 1 monitors minimal and maximal level depth, for example in fire engine cars, tanks etc.
- Function 2 monitors level depth in water collectors, basins, pools etc.
- Selection of particular function is made by jumper on the front panel.
- Device monitors 5 levels by using six probes (one probe is common).
- Level indication by six LED's on the front panel of the device.
- It is possible to connect another indication module (e.g. in fire-engine cabin).
- Measuring frequency 10 Hz to prevent polarization of liquid.
- Supply voltage 12 to 24 V DC (to be used in fire-engines) or galvanically separated 230 V AC for general use.
- Contact relay 10 A for signalization of full/empty tank (according to a chosen function).
- Choice of functions PUMP UP/OFF/PUMP DOWN by a switch located on the front panel of the device.

## Description

### HRH-6/DC Basic unit

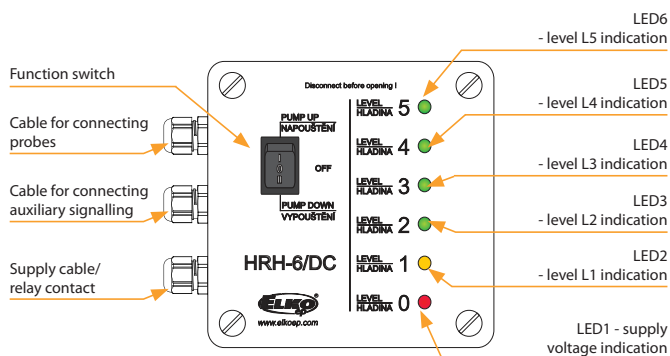

### HRH-6/S Auxiliary signalling

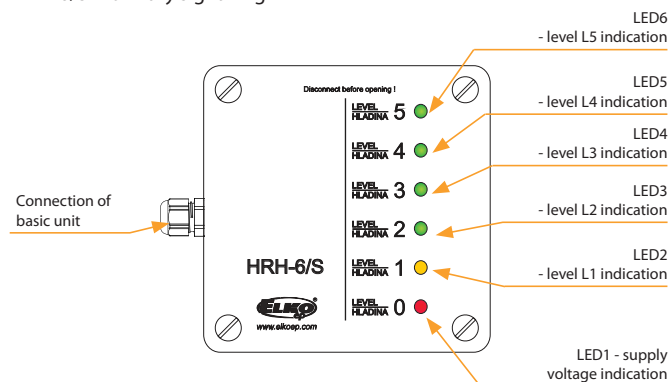

## Setup elements (inside basic unit)

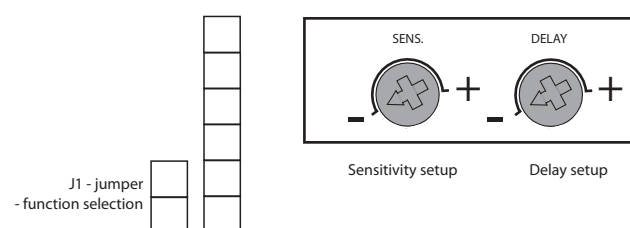

HRH-6 block connecting

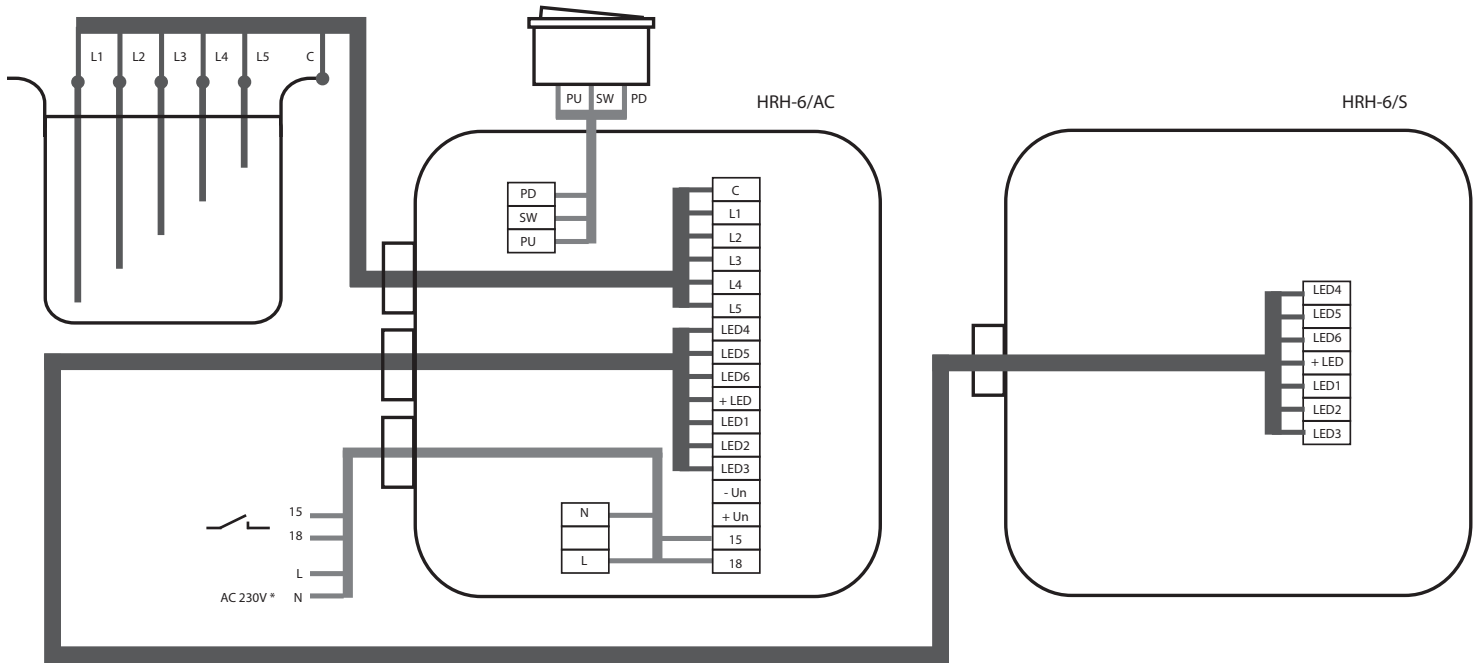

\* In case of HRH-6/DC, incoming supply is connected on terminals +Un and - Un.

Functions

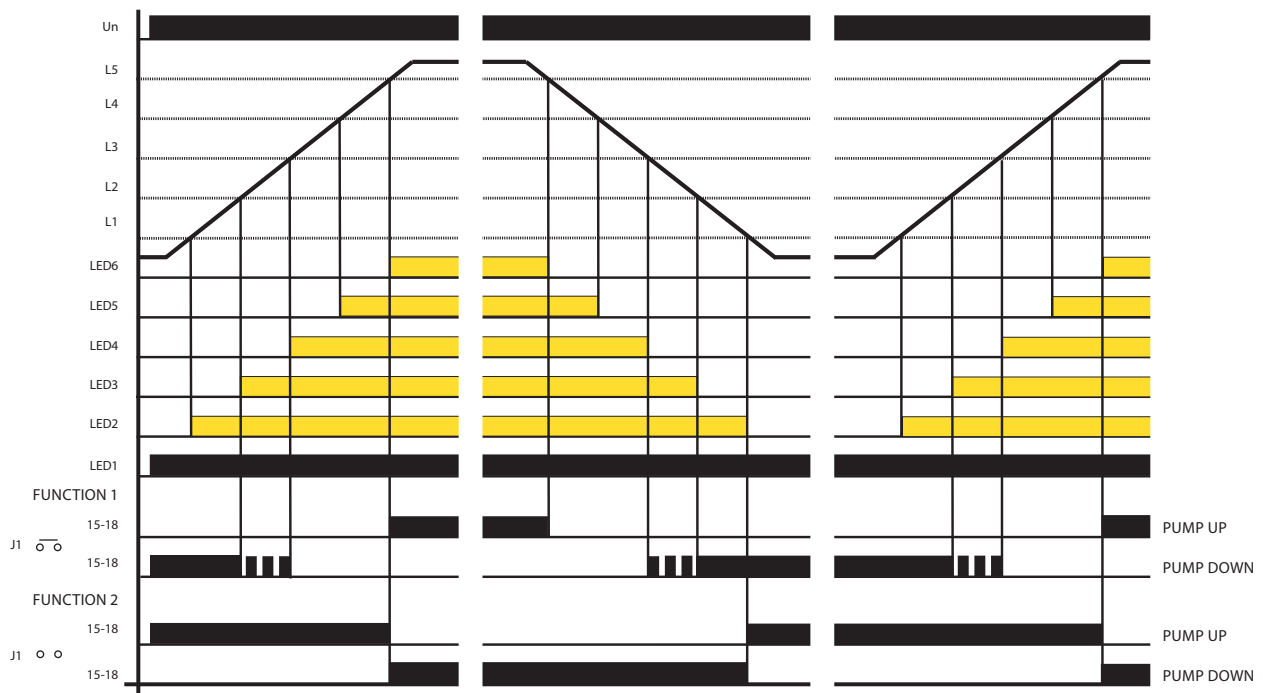

This device monitors level of a conductive liquid in a tank by using six single probes or one 6-fold probe. In case you use a tank made of a conductive material, it is possible to use it as a common probe C.

This common probe is connected to a pole of supply (for fire-engines it means its body) in case of supply voltage 12 to 24 V DC.

In case of supply voltage 230 V AC, the circuits are galvanically separated from the main.

The device is controlled by a three-position switch PUMP UP/OFF/PUMP DOWN. After switching into a position PUMP UP or PUMP DOWN, red LED1 shines and then also LED2 to LED6 according to liquid level. Output relay has 2 selectable functions.

Function setting is done by a jumper on basic board of HRH-6.

**Function 1:** (for use in fire-engines) - jumper is applied. In case of function PUMP UP and level reaching L5, the relay controlling e.g. acoustic signalization, permanently closes and indicated full tank. In case of PUMP DOWN function and level drop under level L3, relay periodically switches and under L2 it switches permanently (indicates almost empty tank).

**Function 2:** (for keeping liquid level) - jumper is not applied. In case of PUMP UP, sensor is switched until liquid reaches level L5. Then relay opens and switches again in case the liquid level falls under level L1. In case of PUMP DOWN - relay is switched until liquid falls under level L1. Then relay opens and switches again on level L5.

To eliminate LED flashing while level gurgle it is possible to delay reaction of probes (set delay 1 to 10 s). According to conductivity of liquid it is possible to set sensitivity of probes (corresponding to "resistance" of liquid).



EAN code  
HRH-4/230V: 8595188117517  
HRH-4/24V: 8595188117500

Technical parameters	HRH-4
Function:	2
Voltage range:	AC/DC 230 V or AC/DC 24 V (AC 50/60 Hz)
Burden:	max. 7 VA/1.5 W
Max. dissipated power (Un + terminals):	4 W
Operating range:	-15 %; +10 %
<b>Measuring circuit</b>	
Sensitivity (input resistance):	adjustable in range 5 kΩ - 100 kΩ
Voltage on electrodes:	max. AC 3.5 V
Current on probes:	AC < 0.1 mA
Time response:	max. 400 ms
Max. capacity of probe cable:	800 nF (sensitivity 5 kΩ), 100 nF (sensitivity 100 kΩ)
Time delay (t):	adjustable, 0.5 - 10 sec
Time delay (t1):	1.5 sec
<b>Accuracy</b>	
Setting accuracy (mech.):	± 5 %
<b>Output</b>	
Number of contacts:	4x switching
Rated thermal current:	25 A
Loading in AC3:	4 kW/400 V
Mechanical life:	3.000.000 operations
<b>Other information</b>	
Operation temperature:	-20 °C to 55 °C (-4 °F to 131 °F)
Storage temperature:	-30 °C to 70 °C (-22 °F to 158 °F)
Dielectrical strength (supply-output):	3.75 kV, galvanically insulated
Operating position:	any
Protection degree:	IP55
Pollution degree:	2
Dimensions:	160 x 135 x 83 mm (6.3" x 5.3" x 3.3")
Weight:	743 g (26.2 oz.)
Standards:	EN 60255-1, EN 60255-26, EN 60255-27, EN 60669-1, EN 60669-2-1
Recommended measuring probes:	see pg. 126

### Function description

- 1) PUMP UP - in case the level falls under a lower limit (sensor D), a relay switches and a pump pumps a liquid up until it reaches an upper limit (probe H), then a relay opens and a pump stops pumping. When a level reaches a lower limit again, all process is repeated. After the device is energized, relay automatically closes and a pump pumps liquid to upper limit.
- 2) PUMP DOWN - in case a level reaches over an upper limit, a relay closes and a pump pumps liquid down. In case a level reaches a lower limit, a relay opens and a pump stops pumping. When energized, a relay is in an open state and a pump operates only after an upper limit is exceeded.
- 3) In case you combine inputs H and D and connect them to one probe, the device will keep only one level (upper and lower limit will become one). In function PUMP UP relay closes in case the level falls under a probe level. A pump pumps liquid up and in case the level reaches a probe level, a relay opens and a pump stops. The level is kept in a small range around the probe. In function PUMP DOWN relays closes in case a level reaches a probe level. A pump pumps down until the level reaches a probe, then relay opens and pump stops.

- In an easy way it automates operations of pumps depending on level.
- Control of level in wells, tanks, reservoirs,...
- It is delivered as a connected set - easy installation.
- Possibility to monitor level of any type of conductive liquid.
- It serves for an automatic operation in 1-phased and 3-phased pumps.
- Set of level switch HRH-5 and a contactor VS425.
- Function choice - pumping up or down.
- Unit requires incoming over-current protection.
- Protection degree of the set is IP65.
- There is a possibility of 4 types of probes in a various design (they are not a part of this set, it is possible to deliver).
- Unit is placed in a plastic box with dimensions 160 x 135 x 83 mm (6.3"x 5.3"x 3.3").

### Function

#### Function PUMP UP

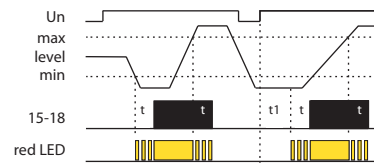

#### Function PUMP DOWN

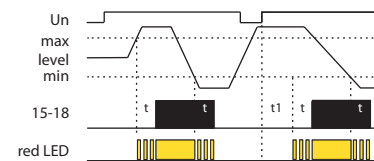

### Connection

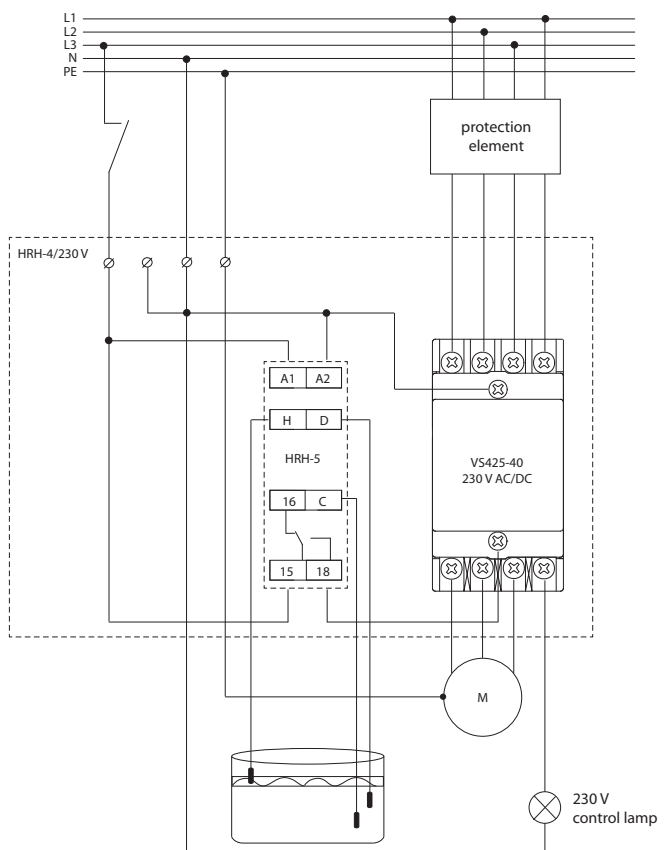



EAN code  
HRH-MS-VS-4A: 8595188150712

Technical parameters	HRH-MS-VS-4A
Function:	2
Voltage range:	230/400 V (AC 50/60 Hz)
Input (max.):	4.6 VA/2 W
Toleration of voltage range:	-15 %; +10 %
<b>Measuring circuit</b>	
Sensitivity (input impedance):	adjustable in range 5 kΩ - 100 kΩ
Voltage on the electrodes:	max. AC 3.5 V
Current in probes:	AC < 0.1 mA
Time response:	max. 400 ms
Max. capacity of probe cable:	800 nF (sensitivity 5 kΩ), 100 nF (sensitivity 100 kΩ)
Time delay (t):	adjustable, 0.5 - 10 sec
Time delay after switching on (t1):	1.5 sec
<b>Accuracy:</b>	
Setting accuracy (mech.):	± 5 %
<b>Output</b>	
Number of contacts:	4
Rated thermal current:	25 A
Load on AC3:	4 A
Switching voltage:	400 V AC
Electric life (A3):	500.000 operations
Current setting range MS18:	2.5 - 4 A
<b>Other information</b>	
Operating temperature:	-20 °C to 55 °C (-4 °F to 131 °F)
Storage temperature:	-25 °C to 70 °C (-13 °F to 158 °F)
Dielectrical strength:	3.75 kV (supply - probe)
Operating position:	any
Protection degree:	IP65 set
Pollution degree:	2
Dimension:	201 x 202 x 120 mm (7.9 x 7.9 x 4.7")
Weight:	1358 g (47.9 oz.)
Related standards:	EN 60255-1, EN 60255-26, EN 60255-27, EN 60669-1, EN 60669-2-1
Recommended measuring probes:	see pg. 126

- Level sets are used to monitor levels in wells, reservoirs, tanks...
- Advantage is the possibility of setting PUMP UP and PUMP DOWN and also delayed switching (e.g. in case of level fluctuations).
- The possibility of connection to 1 or 3-phase pump (depending on the type of set).
- Easy to install without complicated wiring - ready for installation.
- There are Level sets placed in switchboard with IP65 protection (protected against dust and against water jets)
  - HRH-VS: level switch HRH-5 with installation contactor VS425-40 (25 A contact).
  - HRH-MS-VS-4A: level switch HRH-5 with installation contactor VS425-40 (25 A contact) and with motor starter MS18 2.5-4 A.

**Connection**

Level set HRH-MS-VS-4A

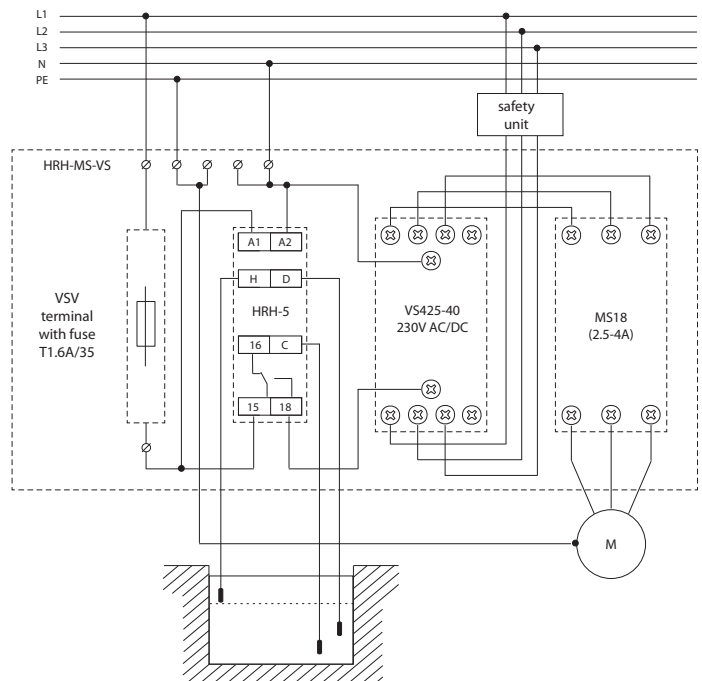

**Functions**

PUMP DOWN function (DOWN) used for protection against Idle Running or against overflow and flooding areas. Detecting the maximum level results in activation of adjusted delayed response. After that output contact immediately turns on single or 3-phase pump, until it reaches the minimum level. Then the pump turns off. In case that a reservoir is made of a conductive material, e.g. metal tanks, there can be a difference in connection of HRH-5 level sets - it is not necessary to put inside a common probe „C“ and connect with SHR-2 probe, but thanks to conductivity of vessel we can connect probe C to the reservoir body. The length of wire cable (between the level switch and probe) can be up to 50 m. We don't recommend placing near the power lines, because the sensitivity of equipment can be affected and thus the entire functionality. **Recommended accessories:**

- 3 wire cable D03VV-F 3x0,75/3,2
- 1 wire cable D05V-K 0,75/3,2
- SHR-2 probe - probe covered by PVC (protected) - used in moderately polluted waters, drilling, wells. Assembly - hanging in the well.

**SHR-1-M, SHR-1-N**

SHR-1-M

SHR-1-N

EAN code  
SHR-1-M: 8595188110105  
SHR-1-N: 8595188111379

**SHR-1-M:** brass sensor

**SHR-1-N:** stainless steel sensor

- Sensor to control flooding.
- Suitable for use in drinking water.
- Electrode with diameter 4 mm (0.2") is placed in plastic cover.
- Panel or to holder mounting.
- Conductor is connected to terminal board, shrink bushing for feeder place insulation is a part of device.
- Max. wire profile: 2.5 mm<sup>2</sup> (AWG10).
- Installation: after connecting a wire to the sensor, run the shrink bushing over the wire onto the sensor.
- Heat the sensor and by shrinking the connection of sensor and wire will be hermetical.
- Weight: 9.7 g (0.3 oz.)
- Operating temperature: -25 °C to +60 °C (-13 °F to 140 °F)
- Total sensor length: 65.5mm (2.58")

**SHR-2**

Level probe **SHR-2**

- Detection sensor is electrode, which in connection with switchable device is used for level detection for example in wells, tanks,...
- To be used in electric conductive fluids and mechanically polluted fluids with temperature: 1°C to 80°C (33.8 °F to 176°F).
- Suitable for use in drinking water.
- Stainless steel one-pole electrode reside in PVC cover, intended for tank wall mounting or mounting by socket.
- To ensure correct function of the sensor, it is necessary to have the electrode without dirt which could disable the connection of the electrode and fluid and thus lead to malfunction.
- Max. wire profile: 2.5 mm<sup>2</sup> (AWG 10).
- Recommended wire D05V-K0.75/3.2.
- Installation:
  - conductor wire is connected by feazing of two brass screws to stainless steel electrode,
  - conductor is caulked by bushing Pg7 with protection degree IP68.
- Weight: 48.6 g (1.7 oz.)
- Dimensions: max. diameter 21 mm (0.8"), length 96 mm (3.8")

SHR-2 in open state



EAN code  
SHR-2: 8595188111263

**SHR-3**

Level probe **SHR-3**

- Stainless probe to be used into demanding industrial environments, designated for screwing into tank wall or cover.
- Suitable for use in drinking water.
- The probe is installed in horizontal, vertical or in sidelong position on tank side or in tank cover. Installation is done by soldering or by fixing nut. It is necessary to use 24 mm (1") screw. It is necessary to use an adequate torque with regards to a seal and operational over-pressure in a tank.
- Sensor has connecting wire - length 3 m, which is connected to sensor to scan electrode and sensor bushing connecting wire is double-wire PVC AWG 18 (0.75 mm<sup>2</sup>), connection of wires: brown - scan electrode, blue - sensor bushing.
- Connection M18x1.5 screw.
- Protection degree IP67.
- Sensor weight without cable: 100 g (3.3 oz.).
- Operating surroundings: place without the danger of detonation, temperature on screw: max. 95°C (203°F).
- Pressure immunity: on 25 °C (77 °F) 4 MPa, on 95 °C (203 °F) 1.5 MPa.
- Weight: 239 g (8.4 oz.).
- Material: bushing and scan electrode: stainless steel W.Nr. 1.4301, insulation insert of electrode: PTFE.
- Internal material: self-extinguishing epoxide resin.
- Operating temperature: -25 °C to 60 °C (-13 °F to 140 °F).
- Total sensor length: 65.5mm (2.58").

EAN code  
SHR-3: 8595188111270

**D03VV-F** | Cables 3x 0.75 mm<sup>2</sup>

EAN code  
D03VV-F 3x0.75/3.2: 8595188165884

Technical parameters	D03VV-F 3x0.75/3.2
Rated voltage:	300/300 V
Test voltage:	2 kV
Capacity:	max. 12.3 nF/100 m (328')
Core diameter with insulation:	3.2 mm (0.12")
Overall diameter of cable:	8.1 mm (0.31")
Section:	0.75 mm <sup>2</sup> (AWG 18)
Length:	1 m (39.37")

- Cable to probes SHR-1 and SHR-2, 3x 0.75 mm<sup>2</sup> (AWG 18) with a certification for drinking water, 1m (39.37').
- Construction:
  - bright copper stranded core of hole
  - core insulation of special PVC
  - sheath of special PVC.
- Technical specifications and usage:
  - the product meets requirements for direct and permanent contact with drinking water according to § 5 of the Act. 258/2000 Decree of the Ministry of Health. 409/2005 Sb., On hygienic requirements for products coming into direct contact with drinking water and water treatment
  - usable up to 70 °C (158 °F)
  - suitable for submersible conductivity probes for the boreholes, wells and tanks
  - suitable for probes used for level detection of conductive liquids
  - cable capacity is max. 12.3 nF/100 m (328').

## Cross-section

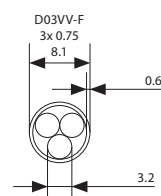
**D05V-K** | Cables and wires suitable

EAN code  
D05V-K 0.75/3.2: 8595188165945

Technical parameters	D05V-K 0.75/3.2
Rated voltage:	300/500 V
Test voltage:	2 kV
Capacity:	max. 12.3 nF/100 m (328')
Core diameter with insulation:	3.2 mm (0.12")
Section:	0.75 mm <sup>2</sup> (AWG 18)
Length:	1 m (3.4')

- Cable to probes SHR-1 and SHR-2, 3x 0.75 mm<sup>2</sup> (AWG 18) with a certification for drinking water, 1m (3.4').
- Construction:
  - bright copper stranded core of hole
  - insulation of special PVC.
- Technical specifications and usage:
  - the product meets requirements for direct and permanent contact with drinking water according to § 5 of the Act. 258/2000 Decree of the Ministry of Health. 409/2005 Sb., On hygienic requirements for products coming into direct contact with drinking water and water treatment
  - usable up to 70 °C (158 °F)
  - suitable for probes used for level detection of conductive liquids.





Analog modular



**TER-3A**  
-30 °C to 10 °C  
(-22 °F to 50 °F)  
external NTC.  
page 131



**TER-3B**  
0 °C to 40 °C  
(32 °F to 104 °F)  
external NTC.  
page 131



**TER-3C**  
30 °C to 70 °C  
(86 °F to 158 °F)  
external NTC.  
page 131



**TER-3D**  
0 °C to 60 °C  
(32 °F to 140 °F)  
external NTC.  
page 131



**TER-3G**  
0 °C to 60 °C  
(32 °F to 140 °F)  
external Pt100.  
page 131



**TER-3H**  
-15 °C to 45 °C  
(5 °F to 113 °F)  
external NTC.  
page 131



**TER-3E**  
0 °C to 60 °C  
(32 °F to 140 °F)  
external NTC.  
page 131



**TER-3F**  
0 °C to 60 °C  
(32 °F to 140 °F)  
in-built NTC.  
page 131



**TER-4**  
Wide and accurate range of setting -40 °C to 110 °C (-40 °F to 230 °F) in ten ranges in one device, fine temperature setting. 2 inputs for NTC sensor, 2 outputs 16 A changeover/SPDT, additional function (memory, hysteresis, indication of faulty sensor). Supply: AC 230 V or AC/DC 24 V (galv. separated).  
page 134



**TER-7**  
Monitoring heating of motor winding in range given by resistance of in-built PTC thermistor(1.8-3.3 kΩ), additional function (memory, reset), output contact 2x 8 A changeover/DPDT, supply: AC/DC 24-240 V.  
page 133

Analogue in increased protection



**TEV-1**  
Thermostat with „dead zone“, independent adjustable range -20 to 20 °C (-4 °F to 68 °F), protection against freezing, water-proof type IP65.  
page 138



**TEV-2**  
Thermostat for regulation of heating (cooling), adjustable range -20 to 20 °C (-4 °F to 68 °F), external sensor NTC, output contact 16 A changeover/SPDT.  
page 139



**TEV-3**  
Thermostat for regulation of heating (cooling), adjustable range 5 to 35°C (41°F to 149 °F), external sensor NTC, output contact 16 A, control potentiometer and indication on panel.  
page 139



**TEV-4**  
Single exteriors thermostat for monitoring and regulation of temperature in demanding environments. Temperature range: -30 °C to 60 °C (22 °F to 140 °F)  
page 140

Digital



**TER-9**  
2 temperature inputs, 2 outputs 8 A changeover/SPDT, 6 functions, in-built time switch clock, LCD with back light, galvanically sep. supply voltage AC 230 V or AC/DC 24 V, 2 MODULE. Temperature range: -40 °C to 110 °C (-40 °F to 230 °F).  
page 136

Hygrostat



**RHV-1**  
Hygro-thermostat for humidity monitoring and regulation in range 0 to 90% RH.  
page 142

Thermovalve



**ATV-1**  
Energy-saving digital thermostat for radiators, with temperature range 8 to 28 °C (48 °F to 82 °F).  
page 143

Hygro-thermostat



**RHT-1**  
Hygro-thermostat for temperature monitoring and regulation in range 0 to 60 °C (32 °F to 140 °F) and relative humidity monitoring and regulation in range 50 to 90 %.  
page 141

Accessories



**TC, TZ, Pt100**  
External temperature sensors for thermostats in lengths 3m, 6m, 12m (9.9', 19.7', 39.4')  
TC/TZ: thermistor NTC 12 kΩ/25 °C (77 °F)  
Pt: element Pt100 (only TER-3G).  
page 145



**Telva**  
It is an appropriate control unit for a wide range of thermostatic valves.  
page 144

Type	Design	Type		Sensor		Supply				Temperature range	Hysteresis	Relative humidity	Designation	Page of catalogue	
		Analog	Digital	In-built	External	Type	AC 230V	AC 24V	AC/DC 24 to 240V						Galv. separated
TER-3A	1M-DIN	●	x	x	●	NTC	x	x	●	x	-30 to 10 °C (-22 °F to 50 °F)	0.5 to 10 °C (32.9 °F to 41 °F)	x	Single thermostat into a switchboard with external sensor for temperature in cooling and against freezing.	131
TER-3B	1M-DIN	●	x	x	●	NTC	x	x	●	x	0 to 40 °C (32 °F to 104 °F)	0.5 to 5 °C (32.9 °F to 41 °F)	x	Single thermostat into a switchboards with external sensor for sensing room and operational temperature.	
TER-3C	1M-DIN	●	x	x	●	NTC	x	x	●	x	+30 to 70 °C (86 °F to 158 °F)	0.5 to 5 °C (32.9 °F to 41 °F)	x	Single thermostat into a switchboards with external sensor for sensing temperature in devices (overheating,...).	
TER-3D	1M-DIN	●	x	x	●	NTC	x	x	●	x	0 to 60 °C (32 °F to 140 °F)	0.5 to 5 °C (32.9 °F to 41 °F)	x	Single thermostat into a switchboard with external sensor for sensing operational temperature of machines and devices.	
TER-3E	1M-DIN	●	x	x	●	NTC	x	x	●	x	0 to 60 °C (32 °F to 140 °F)	1 °C (34 °F)	x	As TER-3D but with fixed hysteresis.	132
TER-3F	1M-DIN	●	x	●	x	NTC	x	x	●	x	0 to 60 °C (32 °F to 113 °F)	1 °C (34 °F)	x	Single thermostat into a switchboard with in-built sensor, monitors operational temperature in a switchboard.	
TER-3G	1M-DIN	●	x	x	●	Pt100	x	x	●	x	0 to 60 °C (32 °F to 140 °F)	0.5 to 5 °C (32.9 °F to 41 °F)	x	As TER-3D but with input for sensor Pt100.	131
TER-3H	1M-DIN	●	x	x	●	NTC	x	x	●	x	-15 to 45 °C (5 °F to 113 °F)	0.5 to 5 °C (32.9 °F to 41 °F)	x	As TER-3A but with a different temperature range - for cooling and heating.	
TER-7	1M-DIN	●	x	x	●	PTC	x	x	●	x	x	Resistance 1.8-3.3 kΩ	x	Thermistor relay for protection of motor overheating, input designated for sensor PTC in-built in motor winding.	133
TER-4	3M-DIN	●	x	x	● (2x)	NTC	●	●	x	●	-40 to 110 °C (-40 °F to 230 °F)	0.5 až 2.5 °C (32.9 °F to 37 °F)	x	Two-state thermostat (2 inputs, 2 outputs), two independent or dependent thermostats, accurate setting, wide temperature range.	134
TEV-1	IP65 box	●	x	x	●	INTC	●	x	x	x	-20 to 20 °C (-4 °F to 68 °F)	1.5 °C (35 °F)	x	Thermostat with "dead zone", control of heating and protection against freezing, box for outdoor use with IP65.	138
TEV-2	IP65 box	●	x	x	●	NTC	●	x	x	x	-20 to 20 °C (-4 °F to 68 °F)	1.5 °C (35 °F)	x	Single thermostat for regulation of heating, short sensor is a part of this device, protection degree IP65.	139
TEV-3	IP65 box	●	x	x	●	NTC	●	x	x	x	5 to 35 °C (41 °F to 149 °F)	1.5 °C (35 °F)	x	As TEV-2 but potentiometer and indication are placed on front panel.	139
TEV-4	IP65 box	x	x	x	●	NTC	●	x	x	x	-30 to 65 °C (-22 °F to 149 °F)	0.5/1.5/4 °C (32.9/35/39 °F)	x	Single exteriors thermostat for monitoring and regulation of temperature in demanding enviroments.	140
TER-9	2M-DIN	x	●	x	● (2x)	NTC	●	●	x	●	-40 to 110 °C (-40 °F to 230 °F)	0.5 až 5 °C (32.9 °F to 41 °F)	x	Multifunction (6thermo functions) digital thermostat with in-built time switch clock, 2 inputs/2 outputs.	136
ATV-1	valve	x	●	●	x	built-in	x	x	x	x	8 to 28 °C (46°F to 82°F)	x	x	Thermostatic direction valves, temperature regulation +8 to +28 °C (46 °F to 82 °F).	143
RHT-1	1M-DIN	●	x	●	x	built-in	x	x	●	x	0 to 60 °C (32 °F to 140 °F)	H - 4 % T- 2.5°C (36.5°F)	50 to 90%	Hygro-thermostat for temperature monitoring and regulation in range 0 °C to +60 °C (32 °F to 140 °F) and relative humidity in range 50 to 90 %.	141
RHV-1	IP65	●	x	●	x	built-in	x	x	x	x	-30 to 60 °C (-22 °F to 140 °F)	2%, 3%, 4%	0 to 30 % RH 30 to 60 % RH 60 to 90 % RH	Hygro-thermostat for humidity monitoring and regulation in range 0 to 90 % RH.	142



EAN code  
 TER-3A: 8595188138390  
 TER-3B: 8595188138406  
 TER-3C: 8595188138413  
 TER-3D: 8595188138420  
 TER-3G: 8595188138451  
 TER-3H: 8595188138468

Technical parameters		TER-3
Function:	single level	
Supply terminals:	A1-A2	
Voltage range:	AC/DC 24 - 240 V (galvanically unseparated) (AC 50/60 Hz)	
Burden:	max. 2 VA/1 W	
Max. dissipated power (Un + terminals):	2.5 W	
Supply voltage tolerance:	- 15 %; + 10 %	
Measuring circuit		
Measuring terminals:	T1 - T1	
Temperature range: (according to product type sensitivity)	TER-3A: -30 °C to 10 °C (-22 °F to 50 °F) TER-3B: 0 °C to 40 °C (32 °F to 104 °F) TER-3C: 30 °C to 70 °C (86 °F to 158 °F) TER-3D: 0 °C to 60 °C (32 °F to 140 °F) TER-3G: 0 °C to 60 °C (32 °F to 140 °F) TER-3H: -15 °C to 45 °C (5 °F to 113 °F)	
Hysteresis:	adjustable in range 0.5 to 5°C/0.9 to 9 °F	
Sensor:	external, thermistor NTC, except for TER-3G (Pt100)	
Sensor fault indication (short circuit/disconnect):	flashing red LED	
Accuracy		
Setting accuracy (mech.):	5 %	
Switching difference:	0.5 °C/0.9 °F	
Temperature dependance:	< 0.1 %/°C (< 0.1 %/°F)	
Output		
Number of contacts:	1x NO-SPST (AgSnO <sub>2</sub> )	
Current rating:	16 A/AC1, 10 A/24 V DC	
Breaking capacity:	4000 VA/AC1, 300 W/DC	
Switching voltage:	250 V AC/24 V DC	
Output indication:	red LED	
Mechanical life:	30.000.000 operations	
Electrical life (AC1):	70.000 operations	
Other information		
Operating temperature:	-20 °C to 55 °C (-4 °F to 131 °F)	
Storage temperature:	-30 °C to 70 °C (-22 °F to 158 °F)	
Dielectrical strength:	2.5 kV (supply - output)	
Operating position:	any	
Mounting:	DIN rail EN 60715	
Protection degree:	IP40 from front panel/IP10 terminals	
Overvoltage category:	III.	
Pollution degree:	2	
Max. cable size (mm <sup>2</sup> ):	solid wire max. 2x 2.5 or 1x 4 with sleeve max. 1x 2.5 or 2x 1.5 (AWG 12)	
Dimensions:	90 x 17.6 x 64 mm (3.5" x 0.7" x 2.5")	
Weight:	64 g (2.3 oz.); TER-3G: 68 g (2.4 oz.)	
Standards:	EN 60255-1, EN 60255-26, EN 60255-27, IEC 60730-2-9	

- Single thermostat for temperature monitoring and regulation in range -30 °C to +70 °C (-22 °F to 158 °F) in six ranges.
- It can be used for monitoring temperature e.g. in switchboards, heating systems, cooling systems, liquids, radiators, motors, devices, open spaces, etc.
- Possibility to set function "heating"/"cooling".
- Adjustable hysteresis (sensitivity), switching by potentiometer in range 0.5 to 5 °C (0.9 to 9 °F).
- Choice of external temperature sensors with double insulation in standard lengths 3, 6 and 12 m (9.8', 19.7' and 39.4').
- It is possible to place sensor directly on terminal block - for temperature monitoring in a switchboard or in its surroundings.
- Red LED indicates status of output, green LED indicates energization of the device.

Description

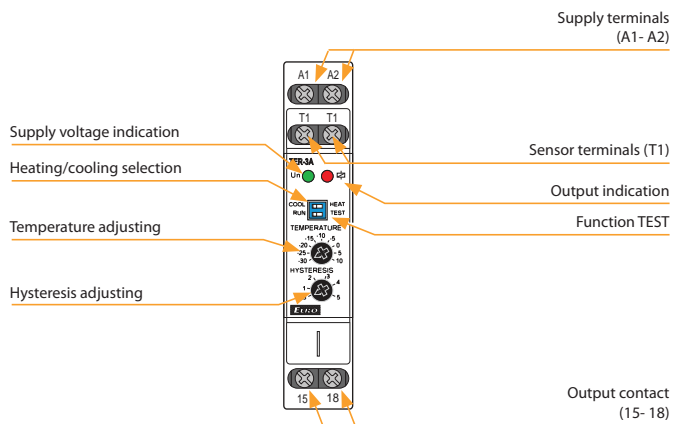

Function

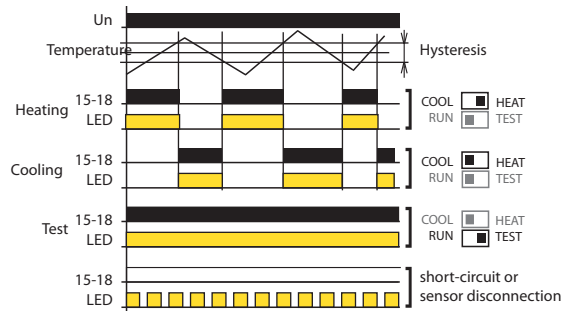

It is a single but practical thermostat with separated sensor for monitoring temperature. Device is placed in a switchboard and external sensor senses temperature of required space, object, or liquid. Supply is not galvanically separated from sensor. Sensor is double insulated. Maximal length of delivered sensor is 12 m/39.4'. device has in-built indication of sensor damage, which means that in case of short-circuit or disconnection red LED flashes. Thanks to adjustable hysteresis, it is advantageous to regulate width of the range and thus define sensitivity of load switching. Sensed temperature is decreased by set hysteresis. When installing it is necessary to keep in mind that hysteresis is increased by temperature gradient between sensor's jacket and thermistor.

Connection

Symbol

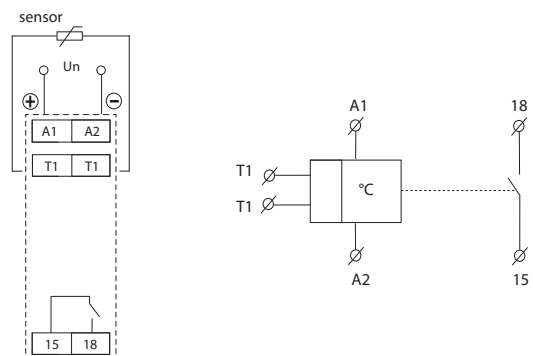

Example of an order

Please specify a type of thermostat in your order (TER-3A, TER-3B .. or TER-3H) types differ in temperature range and supply voltage.



EAN code  
 TER-3E: 8595188138437  
 TER-3F: 8595188138444

Technical parameters	TER-3E	TER-3F
Function:	single level	
Supply terminals:	A1-A2	
Voltage range:	AC/DC 24 - 240 V (AC 50/60 Hz)	
Burden:	max. 2 VA/1 W	
Max. dissipated power (Un + terminals):	2.5 W	
Supply voltage tolerance:	- 15 %; +10 %	
<b>Measuring circuit</b>		
Measuring terminals:	T1 - T1	x
Temperature range:	0 to +60 °C/(32 °F to 140 °F)	
Hysteresis:	fixed 1 °C/(1.8 °F)	
Sensor:	thermistor NTC	in-built
Sensor fault indic. (short-circuit/disconnection):	flashing red LED	
<b>Accuracy</b>		
Setting accuracy (mech.):	5 %	
Switching difference:	0.5 °C (0.9 °F)	
Temperature dependance:	< 0.1 %/°C (°F)	
<b>Output</b>		
Number of contacts:	1x NO - SPST (AgSnO <sub>2</sub> )	
Current rating:	16 A/AC1,10 A/24 V DC	
Breaking capacity:	4000 VA/AC1, 300 W/DC	
Switching voltage:	250 V AC/24 V DC	
Output indication:	red LED	
Mechanical life:	30.000.000 operations	
Electrical life (AC1):	70.000 operations	
<b>Other information</b>		
Operating temperature:	-20 °C to 55 °C (-4 °F to 131 °F)	
Storage temperature:	-30 °C to 70 °C (-22 °F to 158 °F)	
Dielectrical strength:	2.5 kV (supply - output)	
Operating position:	any	
Operating position:	DIN rail EN 60715	
Mounting:	IP40 from front panel/IP10 terminals	
Protection degree:	III.	
Overvoltage category:	2	
Pollution degree:	solid wire max. 2x 2.5 or 1x 4	
Max. cable size (mm <sup>2</sup> ):	with sleeve max. 1x 2.5 or 2x 1.5 (AWG 12) 90 x 17.6 x 64 mm (3.5" x 0.7" x 2.5")	
Dimensions:	64 g (2.3 oz.)	60 g (2.1 oz.)
Weight:	EN 60255-1, EN 60255-26, EN 60255-27, IEC 60730-2-9	
Standards:		

#### Example of an order

Please specify a type of thermostat in your order (TER-3E, TER-3F).

- Single thermostat for temperature monitoring and regulation in range 0 to +60 °C (32 °F to 140 °F).
- It can be used for temperature monitoring e.g. in switchboards, heating systems, liquids, radiators, motors, devices, open spaces, etc.
- Fixed hysteresis at 1 °C/(1.8 °F).
- TER-3E: choice of external temperature sensors with double insulation in standard lengths 3 (9.8'), 6 (19.7') and 12 m (39.4').
- TER-3F: sensor is a part of device, serves for monitoring temperature in a switchboard.

#### Description

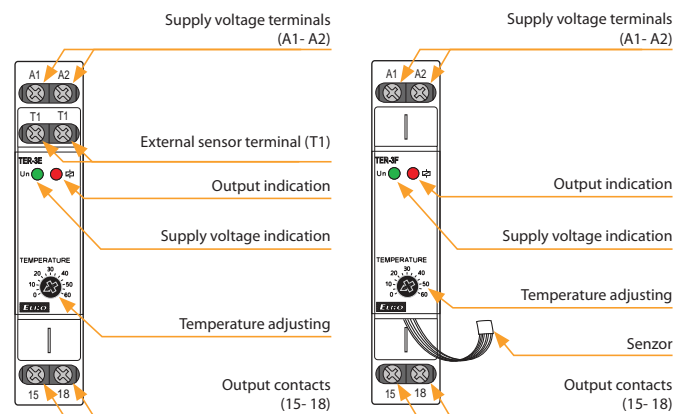

#### Function

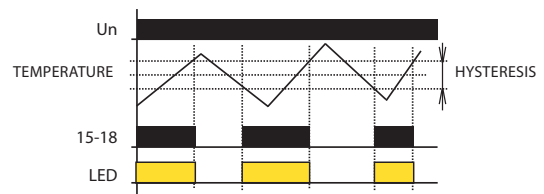

It is a single thermostat for temperature monitoring with separated sensor (except for TER-3F). Device is located in a switchboard and external sensor senses temperature of required space, object or liquid. Supply is not galvanically separated from sensor but sensor is double insulated. Maximal length of sensor cable is 12 m (39.4'). Temperature sensing is decreased by set hysteresis. When installing it is necessary to keep in mind that hysteresis is increased by temperature gradient between sensor's jacket and thermistor.

#### Connection

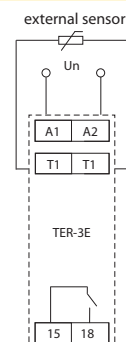

#### Symbol

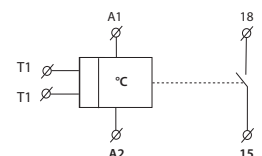



EAN code  
TER-7: 8595188137164

Technical parameters		TER-7
Function:	monitoring temperature of motor winding	
Supply terminals:	A1-A2	
Voltage range:	AC/DC 24 - 240 V (AC 50/60 Hz)	
Burden:	max. 2 VA/1 W	
Max. dissipated power (Un + terminals):	2.5 W	
Supply voltage tolerance:	-15 %; +10 %	
Measuring circuit		
Measuring terminals:	Ta-Tb	
Cold sensor resistance:	50 Ω - 1.5 kΩ	
Upper level:	3.3 kΩ	
Bottom level:	1.8 kΩ	
Sensor:	PTC temperature of motor winding	
Sensor failure indication:	blinking red LED	
Accuracy		
Accuracy in repetition:	< 5 %	
Switching difference:	± 5 %	
Temperature dependance:	< 0.1 %/°C	
Output		
Number of contacts:	2x changeover/DPDT (AgNi/Silver Alloy)	
Current rating:	8 A/AC1	
Breaking capacity:	2000 VA/AC1, 192 W/DC	
Inrush current:	10 A/< 3 s	
Switching voltage:	250 V AC/24 V DC	
Mechanical life:	30.000.000 operations	
Electrical life (resistive):	70.000 operations	
Other information		
Operating temperature:	-20 °C to 55 °C (-4 °F to 131 °F)	
Storage temperature:	-30 °C to 70 °C (-22 °F to 158 °F)	
Dielectrical strength:	4 kV (supply - output)	
Operating position:	any	
Mounting:	DIN rail EN 60715	
Protection degree:	IP40 from front panel/IP20 terminals	
Overvoltage category:	III.	
Pollution degree:	2	
Max. cable size (mm <sup>2</sup> ):	solid wire max. 1x 2.5 or 2x 1.5/ with sleeve max. 1x 2.5 (AWG 12)	
Dimensions:	90 x 17.6 x 64 mm (3.5" x 0.7" x 2.5")	
Weight:	71 g (2.5 oz.)	
Standards:	EN 60255-1, EN 60255-26, EN 60255-27, IEC 60730-2-9	

**Note**

Sensors could be in series in abide with conditions in technical specification - switching limits.

Warning:  
In case of supply from the main, neutral wire must be connected to terminal A2!

- It monitors motor coil temperature.
- Fixed levels of switching.
- PTC sensor is used for sensing, it is in-built in motor winding by its manufacturer or there is used an external PTC sensor.
- MEMORY function - relay is blocked in an error state until until operator intervention (press RESET button).
- RESET of faulty state:
  - a) button on the front panel (remote)
  - b) by external contact (remote by two wires).
- Terminals of sensor are galvanically separated, they can be shorted out by terminal PE without damaging the device.

**Description**

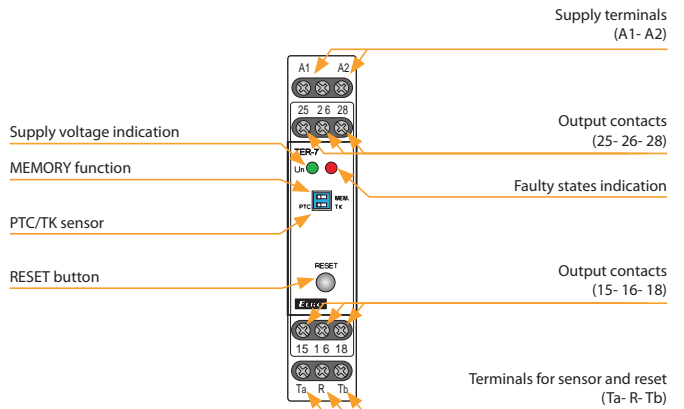

**Function**

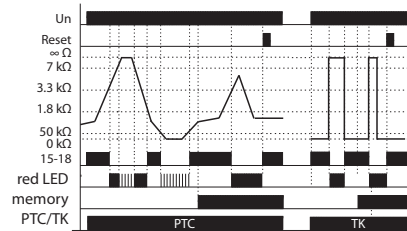

The device controls temperature of motor winding with PTC thermistor which is mostly placed in motor winding or very close to it. Resistance of PTC thermistor run to max 1.5 kΩ in cold stage. By temperature increase the resistance goes strongly up and by overrun the limit of 3.3 kΩ the contact of output relay switch off - mostly contactor controlling a motor. By temperature decrease and thereby decrease of thermistor resistance under 1.8 kΩ the output contact of relay again switches on. The relay has function "Control of sensor fault". This controls interruption or disconnection of sensor. When switch is in position "TK" monitoring of faulty sensor is not functional - it is possible to connect bimetal sensor with only 2 states: ON or OFF. The device can work with bi-metal sensor in this position. Other safety unit is function "Memory". By temperature overrun (and output switches off) the output is hold in faulty stage until service hit. This bring the relay to normal stage (with RESET button) on front panel or by external contact (remote).

**Connection**

**Symbol**

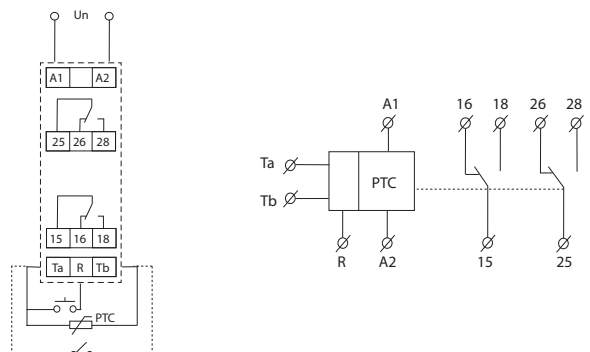



EAN code  
 TER-4 /230V: 8594030337806  
 TER-4 /24V: 8594030338148

Technical parameters		TER-4
Function:	double thermostat	
Supply terminals:	A1-A2	
Voltage range:	AC 230 V (AC 50/60 Hz), AC/DC 24 V galvanically separated	
Burden max.:	5 VA/2.5 W	
Max. dissipated power (Un + terminals):	5.5 W	
Supply voltage tolerance:	- 15 %; + 10 %	
Measuring circuit		
Measuring terminals:	T1-T1 and T2-T2	
Temperature ranges (set via switch individually for each level):	-40 to -25 °C (-458 to -13 °F)	+35 to +50 °C (95 to 122 °F)
	-25 to -10 °C (-13 to 14 °F)	+50 to +65 °C (122 to 149 °F)
	-10 to +5 °C (14 to 41 °F)	+65 to +80 °C (149 to 176 °F)
	+ 5 to +20 °C (41 to 68 °F)	+80 to +95 °C (176 to 203 °F)
	+20 to +35 °C (68 to 95 °F)	+95 to +110 °C (203 to 230 °F)
Fine temperature setting:	0-15 °C, in selected range	
Hysteresis for T1:	adjustable, 0.5 or 2.5 °C/0.9 or 4.5 °F (DIP switch)	
Hysteresis for T2:	adjustable, 0.5 or 2.5 °C/0.9 or 4.5 °F (DIP switch)	
Sensor:	thermistor NTC 12 kΩ/ 25 °C (77 °F)	
Sensor failure indication:	yellow LED +Red LED flashes	
Accuracy		
Setting accuracy (mech.):	5 %	
Temperature dependance:	< 0.1 %/°C (°F)	
Output		
Number of contacts:	2x changeover/SPDT (AgNI/Silver Alloy)	
Current rating:	16 A/AC1	
Breaking capacity:	4000 VA/AC1, 384 W/DC	
Inrush current:	30 A/< 3 s	
Switching voltage:	250 V AC/24 V DC	
Output indication:	red LED	
Mechanical life:	30.000.000 operations	
Electrical life (AC1):	70.000 operations	
Other information		
Operating temperature:	-20 °C to 55 °C (-4 °F to 131 °F)	
Storage temperature:	-30 °C to 70 °C (-22 °F to 158 °F)	
Dielectrical strength:	4 kV (supply - output)	
Operating position:	any	
Mounting:	DIN rail EN 60715	
Protection degree:	IP40 from front panel/IP20 terminals	
Overvoltage category:	III.	
Pollution degree:	2	
Max. cable size (mm²):	solid wire max. 1x 2.5 or 2x 1.5/ with sleeve max. 1x 1.5 (AWG 12)	
Dimensions:	90 x 52 x 65 mm (3.5" x 2" x 2.6")	
Weight:	240 g/8.9 oz (230 V), 146 g/5.4 oz (24 V)	
Standards:	EN 60255-1, EN 60255-26, EN 60255-27, IEC 60730-2-9	

- Double thermostat for temperature monitoring and regulation over a wide range of temperatures.
- Temperature range switch and fine temperature setting for each thermostat.
- Usable for temperature monitoring in switchboards, heating or cooling systems, motors, liquids, open spaces, etc.
- Galvanically isolated power supply AC 230 V or AC/DC 24 V.
- 2 inputs for temperature sensors NTC 12 k/25 °C.
- Setting independent or dependent thermostat function (see function description).
- Heating/cooling function selection.
- Adjustable switching hysteresis (sensitivity).
- Two output relays (for each level independent).

Description

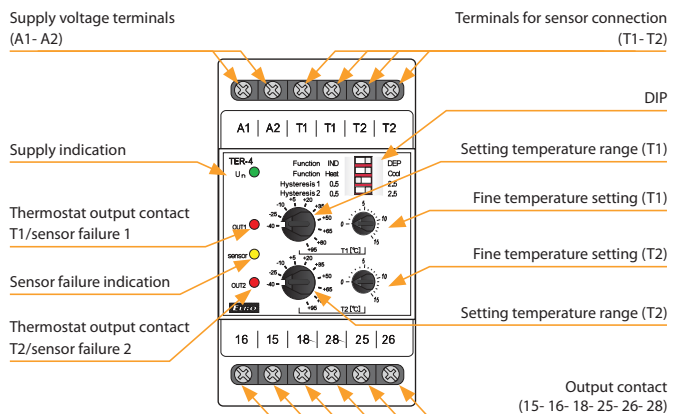

Description and importance of DIP switches

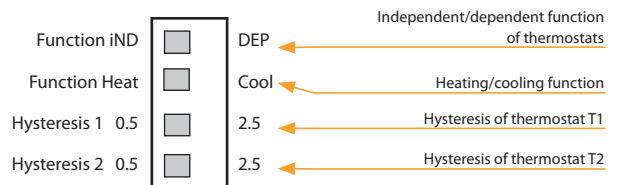

Connection

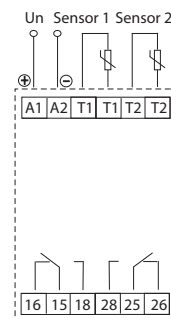

Symbol

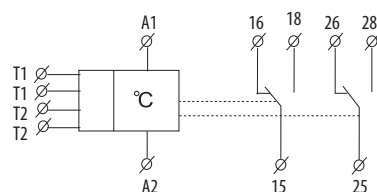

**Function**

Each thermostat has its own temperature sensor, coarse and fine temperature setting, hysteresis setting and its output relay.

The set temperature is set as the sum of the selected temperature range and fine temperature setting.

Example: Required temperature ..... + 25 °C (77 °F)  
 Set range ..... + 20 °C (68 °F)  
 Fine setting ..... 5 °C (41 °F)

The device monitors the failure status of each sensor (short circuit or interruption) - if the sensor fails, the yellow LED is lit and the corresponding red LED flashes. The relevant relay is disconnected when it fails.

The device can also be operated as a single thermostat (single sensor). In this case, a 10 kΩ resistor (part of the product package) must be connected to the unused input.

Independent thermostat function

The device acts as 2 single simple thermostats

Dependent function of thermostats

The thermostats are connected "in series" - i.e. the thermostat 1 is blocked by thermostat 2. This can be used, for example, when thermostat 1 is operational and the thermostat 2 is blocked (emergency - for example, when overheating the device).

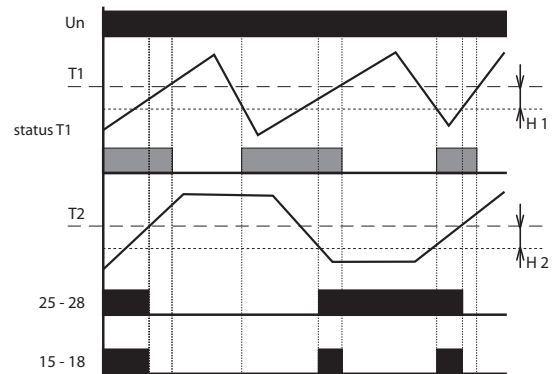
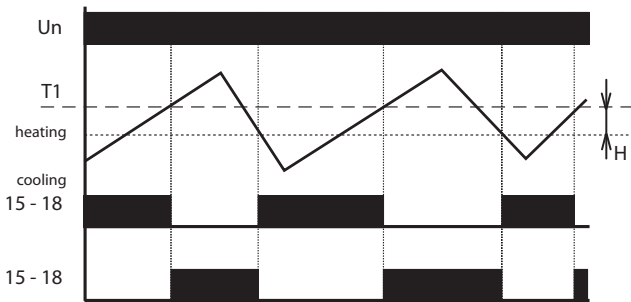



EAN code  
TER-9 /230V: 8595188124478  
TER-9 /24V: 8595188129190

Technical parameters		TER-9
<b>Supply</b>		
Number of function:	6	
Supply terminals:	A1 - A2	
Voltage range:	AC 230 V (AC 50/60 Hz) galvanically separated, AC/DC 24 V galvanically unseparated	
Burden:	max. 4 VA/0.5 W	
Max. dissipated power (Un + terminals):	3 W	
Supply voltage tolerance:	-15 %; +10 %	
Type backup battery:	CR 2032 (3 V)	
<b>Measuring circuit</b>		
Measuring terminals:	T1-T1 and T2-T2	
Temperature range:	-40 to +110 °C (-40 to +230 °F)	
Hysteresis (sensitivity):	in an adjustable range 0.5 to 5 °C (0.9 to 9 °F)	
Difference temperature:	adjustable 1 to 50 °C (34 to 122 °F)	
Sensor:	thermistor NTC 12 kΩ at 25 °C (77 °F)	
Sensor failure indication:	displayed on the LCD	
<b>Accuracy</b>		
Measuring accuracy:	5 %	
Repeat accuracy:	< 0.5 °C (0.9 °F)	
Temperature dependance:	< 0.1 %/°C (°F)	
<b>Output</b>		
Number of contacts:	1x changeover for each output/SPDT, (AgNi)	
Current rating:	8 A/AC1	
Max. breaking capacity:	2000 VA/AC1, 240 W/DC	
Switching voltage:	250 V AC/30 V DC	
Output indication:	symbol ON/OFF	
Mechanical life:	10.000.000 operations	
Electrical life (AC1):	100.000 operations	
<b>Time circuit</b>		
Power back-up:	max. ±1 s per day, at 23°C (73.4 °F)	
Accuracy:	1 min	
Min. switching interval:	min. 10 years	
Data stored for:		
<b>Program circuit</b>		
Number of memory places:	daily, weekly, yearly	
Program:	LCD display, with back light	
Data readout:		
<b>Other information</b>		
Operating temperature:	-10 °C to 55 °C (14 °F to 131 °F)	
Storage temperature:	-30 °C to 70 °C (-22 °F to 158 °F)	
Dielectrical strength:	4 kV (power supply - output)	
Operating position:	any	
Mounting:	DIN rail EN 60715	
Protection degree:	IP20 terminals, IP40 from front panel	
Overvoltage category:	III.	
Pollution degree:	2	
Max. cable size (mm <sup>2</sup> ):	solid wire max. 1x2.5 or 2x1.5/ with sleeve max. 1x2.5 (AWG 12) 90 x 35 x 64 mm (3.5 x 1.4 x 2.5")	
Dimensions:	150 g/5.3 oz. (230 V)	113 g/4 oz. (24 V)
Weight:	EN 61812-1; EN 60255-1, EN 60255-26, EN 60255-27,	
Standards:	IEC 60730-2-9	

- Digital thermostat with 6 functions and built-in time switch clock with day, week and year program. You can also limit temperature functions and courses this way in real time.
- Complex control of home and water heating, solar heating, etc.
- Two thermostats in one, two temperature inputs, two outputs with dry contact.
- Maximum universal and variable thermostat including all ordinary thermostat functions.
- Functions: two independent thermostats, dependent thermostat, differential thermostat, two level thermostat, zone-based thermostat, dead zone thermostat.
- Program setting of output functions, calibration of sensors according to reference temperature (offset).
- The thermostat is subject to the digital clock programs.
- Wide operating range of temperature settings, the possibility of measuring in °C and °F.
- Clear display of set and measured data on a backlit LCD.
- Power supply: AC 230 V or 24 V AC/DC (based on type of device).
- The time switch clock has a battery backup, which retains data in case of a power outage (backup time is up to 3 years).
- Easy replacement of the backup battery through the plug-in module, no disassembling is required.
- Output contact 1x changeover/SPDT 8 A/250 V AC1 for each output.
- 2-MODULE, DIN rail mounting.

### Device description

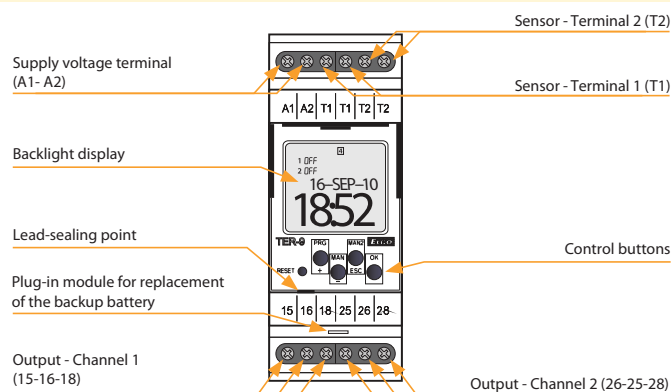

### Description of visual elements on the display

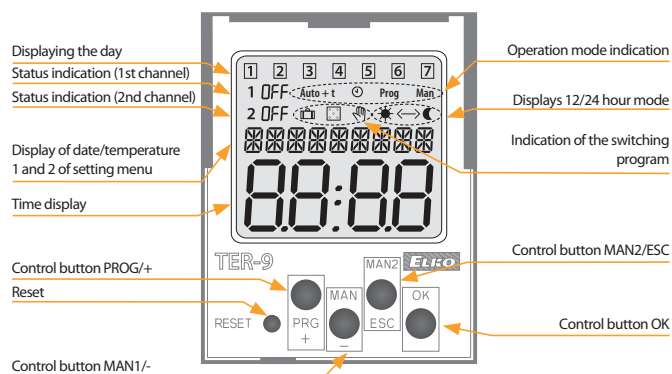

### Connection

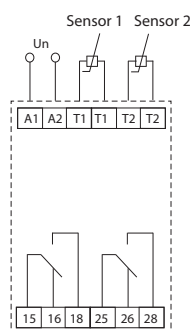

### Symbol

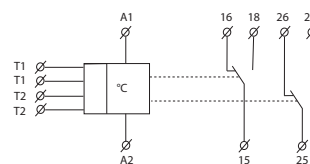



1. 2 independent single-stage thermostats

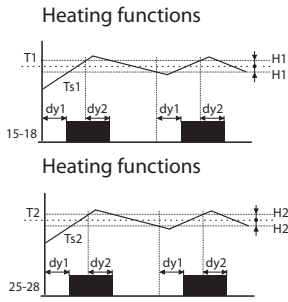

**Legend:**  
 Ts1 - real (measured) temperature 1  
 Ts2 - real (measured) temperature 2  
 T1 - adjusted temperature T1  
 T2 - adjusted temperature T2  
 H1 - adjusted hysteresis for T1  
 H2 - adjusted hysteresis for T2  
 dy1 - set switching delay of the output  
 dy2 - set delay on output breaking  
 15-18 output contact (for T1)  
 25-28 output contact (for T2)

Classic function of thermostat, output contact switched until adjusted temperature is reached. Hysteresis eliminates frequent switching - output oscillation.

2. Depending functions of 2 thermostats

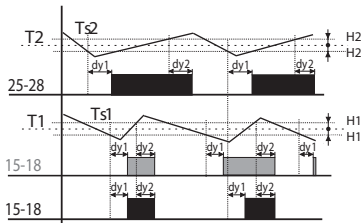

**Legend:**  
 Ts1 - real (measured) temperature 1  
 Ts2 - real (measured) temperature 2  
 T1 - adjusted temperature T1  
 T2 - adjusted temperature T2  
 H1 - adjusted hysteresis for T1  
 H2 - adjusted hysteresis for T2  
 dy1 - set switching delay of the output  
 dy2 - set delay on output breaking  
 25-28 output contact (for T2)  
 15-18 output contact (intersection T1 and T2)

Output 15 - 18 is closed, if temperature of both thermostats is below an adjusted level. When any thermostat reaches adjusted level, the contact 15 - 18 opens. Serial inner connection of thermostats (logic function AND).

3. Differential thermostat

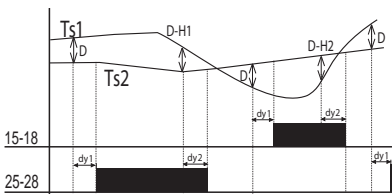

**Legend:**  
 Ts1 - real (measured) temperature T1  
 Ts2 - real (measured) temperature T2  
 D - adjusted difference  
 H1 - adjusted hysteresis for T1  
 H2 - adjusted hysteresis for T2  
 dy1 - set switching delay of the output  
 dy2 - set delay on output breaking  
 15-18 output contact (for T1)  
 25-28 output contact (for T2)

Switching of output corresponds with input, which has lower temperatures when difference is exceeded. Differential thermostat is used for keeping two identical temperature e.g. in heating systems (boiler and reservoir), solar systems (collector - reservoir, exchanger), water heating (water heater, water distribution) etc.

4. 2-stage thermostat

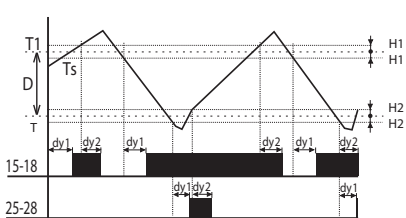

**Legend:**  
 Ts - real (measured) temperature  
 T1 - adjusted temperature  
 T = T1 - D  
 D - adjusted difference  
 H1 - adjusted hysteresis for T1  
 H2 - adjusted hysteresis for T  
 dy1 - set switching delay of the output  
 dy2 - set delay on output breaking  
 15-18 output contact  
 25-28 output contact

Typical example of use for two-stage thermostat is e.g. in boiler-room, where there are two boilers from which one is main and the other one is auxiliary. The main boiler is managed according to set temperature and auxiliary boiler is switched in case, temperature falls under set difference. Thus it helps to the main boiler in case, outside temperature dramatically falls. In the range of set difference (D) output 15-18 functions as normal thermostat to input 1 (type 1). In case temperature falls under set difference, second output switches too.

5. Thermostat with "WINDOW"

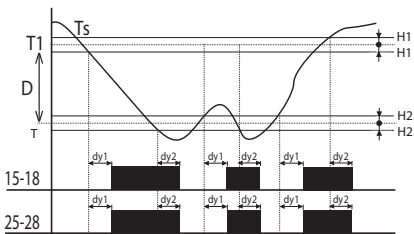

**Legend:**  
 Ts - real (measured) temperature  
 T1 - adjusted temperature  
 T = T1 - D  
 D - adjusted difference  
 H1 - adjusted hysteresis for T1  
 H2 - adjusted hysteresis for T  
 dy1 - set switching delay of the output  
 dy2 - set delay on output breaking  
 15-18 output contact  
 25-28 output contact

Output is closed (heating) only if temperature is within adjusted range. If temperature is out of range, the contact opens. T is set as T1-D. The function is used for protection of gutters against freezing.

6. Thermostat with dead zone

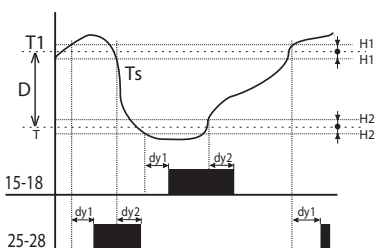

**Legend:**  
 Ts - real (measured) temperature  
 T1 - adjusted temperature  
 T = T1 - D  
 D - adjusted difference  
 H1 - adjusted hysteresis for T1  
 H2 - adjusted hysteresis for T  
 dy1 - set switching delay of the output  
 dy2 - set delay on output breaking  
 15-18 output contact (heating)  
 25-28 output contact (cooling)

In case of thermostat with a „dead zone“, it is possible to set temperature T1 and a difference (respectively a width of dead zone D). If temperature is higher than T1, output contact of cooling switches ON; if the temperature gets below T1, the contact switches OFF. If the temperature gets below temperature T, the contact of heating switches ON and it switches OFF when temperature T is exceeded. This function can be used for example for automatic air warming and cooling in ventilation so the sit is always within the range T1 and T.



EAN code  
TEV-1: 8595188129121

Technical parameters		TEV-1
Function:	two-level thermostat	
Supply terminals:	L - N	
Voltage range:	AC 230 V (50/60 Hz)	
Input:	max. 2.5 VA/0.5 W	
Max. dissipated power (Un + terminals):	3 W	
Tolerance of voltage range:	±15 %	
Measuring circuit		
Measuring terminals:	T - T	
Temperature ranges		
thermostat 1:	-20 to 20°C (-4 °F to 68 °F)	
thermostat 2:	-20 to 20°C (-4 °F to 68 °F)	
Hysteresis (sensitivity):	3°C (± 1.5 °C)/37.4 °F (± 34.7 °F)	
Sensor:	thermistor NTC 12 kΩ/25 °C (77 °F)	
Faulty sensor indication:	red LED flashing	
Accuracy		
Accuracy of settings (mech.):	5 %	
Dependence on temperature:	< 0.1 %/°C (°F)	
Output		
Number of contacts:	1x changeover/SPDT (AgNi/Silver Alloy)	
Current rating:	16 A/AC1	
Max. breaking capacity:	4000 VA/AC1, 384 W/DC	
Peak current:	30 A/< 3 s	
Switched voltage:	250 V AC	
Output indication:	LED	
Mechanical life:	30.000.000 operations	
Electrical life:	70.000 operations	
Other information		
Operation temperature:	-30 °C to 50 °C (-22 °F to 140 °F)	
Operation position:	any	
Protection degree:	IP65	
Overvoltage category:	III.	
Pollution level:	2	
Max. cable size (mm <sup>2</sup> ):	solid wire 2.5/ with sleeve 1.5 (AWG 12)	
Dimensions:	110 x 135 x 66 mm (4.33 "x 5.3 "x 6.6 ")	
Weight:	270 g (9.5 oz.)	
Standards:	EN 60255-1, EN 60255-26, EN 60255-27, IEC 60730-2-9	

- Two-level thermostat with function "WINDOW" meaning that output is switched in case, the measured temperature is within set range (adjustable in range -20 až +20 °C/-4 °F to +68 °F).
- Used as protection against freezing (water-shoots, pavements, drives, pipes, etc.) heating is on, when temperature falls under set upper level (e.g. +5 °C/+41 °F) and off in case it falls under lower level (e.g. -10 °C/-50 °F, when heating is not able effectively operate).
- Thermostat is placed in water-proof box with IP65, which allows installation outside, with in-built sensor TZ-0.
- Thermostat status is indicated by LED (3 colors) under transparent cover.
- Function monitoring short-circuit and sensor disconnection (break).

### Description

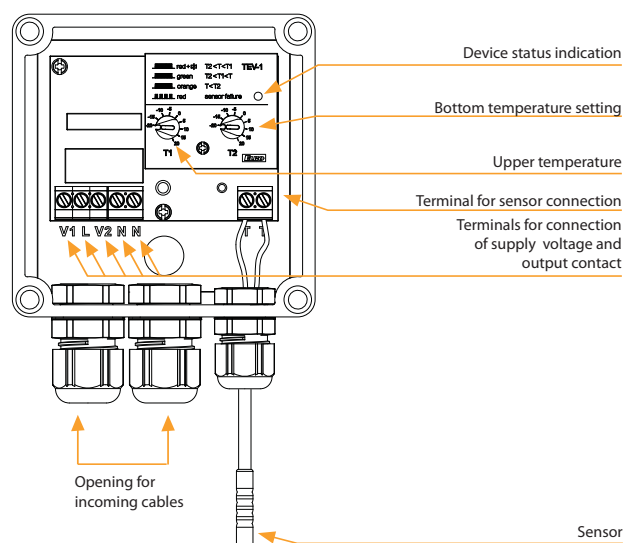

### Function

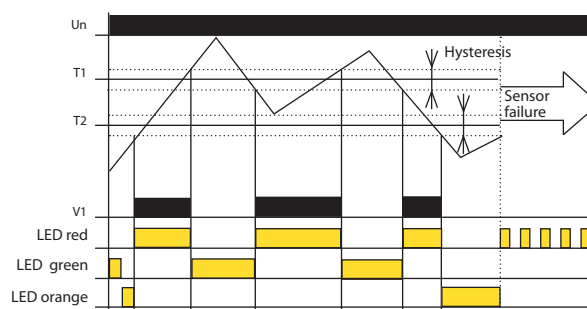

TEV-1 is a double thermostat designated for system of protection of roof water-shoots against freezing. The device is placed in a waterproof box (IP65), sensor with double insulation, which is a part of the device, senses ambient temperature. The device operates as zonal thermostat with independent setting of upper and bottom operational temperature. In case the ambient temperature is higher than T1 (upper temperature), thermostat switches heating of watershoots off (icing melts down). In case the ambient temperature is lower than T2 (bottom temperature), thermostat also switches heating off (to big freezing-heating cannot manage to melt the ice).

### Symbol

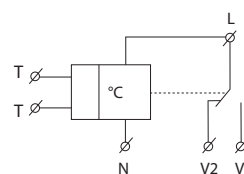

### Function heating

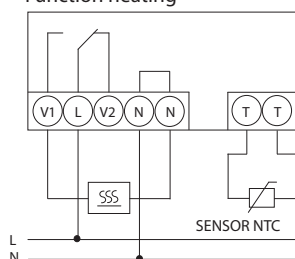

### Function cooling

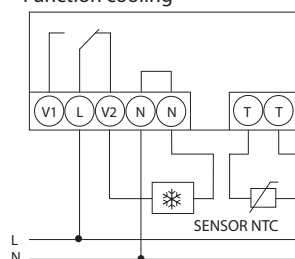



EAN code  
TEV-2: 8595188129251  
TEV-3: 8595188129268

Technical parameters	TEV-2	TEV-3
Function:	one-level thermostat	
Supply terminals:	L - N	
Voltage range:	AC 230 V (50/60 Hz)	
Input:	max. 2.5 VA/0.5 W	
Max. dissipated power:	3 W (Un + terminals)	
Tolerance of voltage range:	± 15 %	
<b>Measuring circuit</b>		
Measuring terminals:	T - T	
Temperature ranges:	-20 to 20°C (-4 to 68°F)	5 to 35°C (41 to 95°F)
Hysteresis (sensitivity):	3°C (± 1.5°C)/37.4°F (± 34.7°F)	
Sensor:	thermistor NTC 12 kΩ	
Faulty sensor indication:	red LED flashing	
<b>Accuracy</b>		
Accuracy of settings (mech.):	5 %	
Dependance on temperature:	< 0.1 %/°C (°F)	
<b>Output</b>		
Number of contacts:	1x changeover/SPDT (AgNi/Silver Alloy)	
Current rating:	16 A/AC1	
Max. breaking capacity:	4000 VA/AC1, 384 W/DC	
Peak current:	30 A/< 3 s	
Switched voltage:	250 V AC	
Output indication:	red LED	
Mechanical life:	30.000.000 operations	
Electrical life (AC1):	70.000 operations	
<b>Other information</b>		
Operation temperature:	-30 to 50 °C (-22 °F to 122°F)	
Operation position:	any	
Protection degree:	IP65	
Overvoltage category:	III.	
Polution level:	2	
Max. cable size (mm²):	solid wire 2.5/ with sleeve 1.5 (AWG 12)	
Dimensions:	110 x 135 x 66 mm (4.33"x 5.3"x 2.3")	
Weight:	270 g (9.5 oz.)	274 g (9.7 oz.)
Standards:	EN 60255-1, EN 60255-26, EN 60255-27, IEC 60730-2-9	

- Single thermostat with possibility of temperature management in adjustable range (it is possible to modify this range or make a special one on request).
- Used to regulate heating (or cooling) in demanding environments (outside, humidity, dustiness, etc.).
- Thermostat is placed in water-proof box with IP65 protection, which enables installation outside, with in-built sensor.
- **TEV-2:** control and indication elements are placed under transparent cover.
- **TEV-3:** control and indication elements are placed directly on the cover (for easy orientation and frequent change of temperature).
- Thermostat status is indicated by LED (2 colours).
- Function of monitoring sensor disconnection and short-circuit.

Description TEV-2 (without cover)

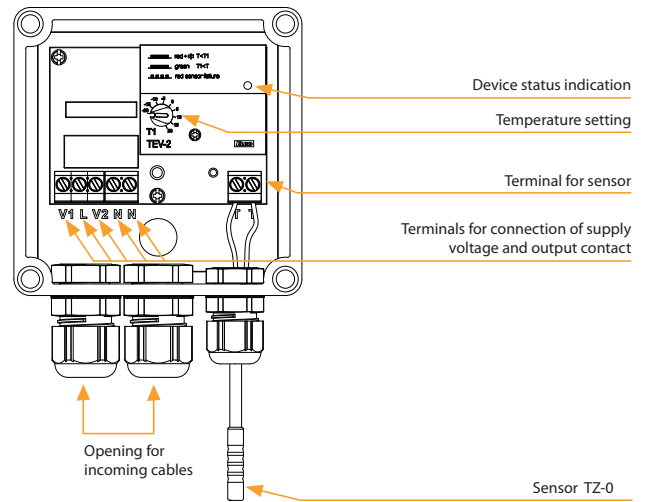

Description TEV-3 (cover)

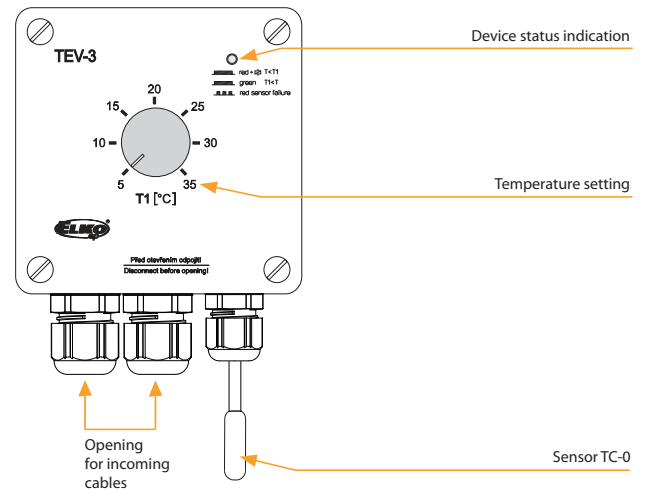

Function TEV-2,TEV-3

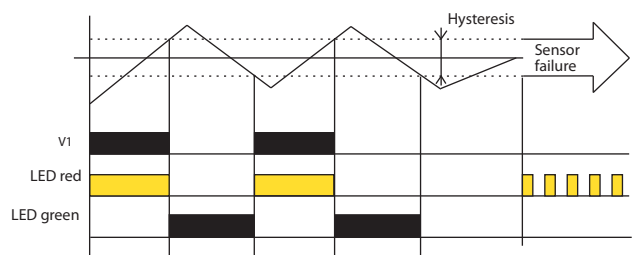

TEV-2 and TEV-3 are universal single thermostats for universal use. In case ambient temperature is higher than set temperature relay is open (function HEATING), for cooling function (opposite function) is possible to use NC contact of relay (V2).

Connection

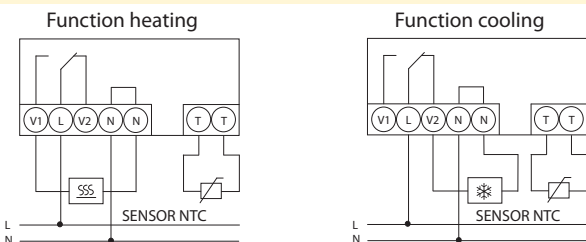

Symbol

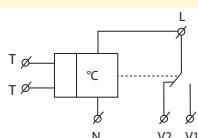



EAN code  
TEV-4: 8595188140577

Technical parameters		TEV-4
<b>Supply</b>		
Supply terminals:	L - N	
Voltage range:	AC 230 V (50/60 Hz)	
Input (apparent / loss):	max. 6 VA/0.7 W	
Max. dissipated power (Un + terminals):	2.5 W	
Tolerance of voltage range:	- 15 % to +10 %	
<b>Function</b> setting by jumper J3		
Function - ❄️:	cooling	
Function - 🔥:	heating	
<b>Temperature setting</b> by jumper J2		
range 1:	-30 °C to 0 °C (-22 °F to 32 °F)	
range 2:	0 °C to 30 °C (32 °F to 86 °F)	
range 3:	30 °C to 60 °C (86 °F to 140 °F)	
Slight temperature setting:	potentiometer	
<b>Hysteresis</b> 0.5/1.5/4 °C (32.9/34.7/39.2 °F)		
Hysteresis setting:	by jumper J1	
<b>Output</b>		
Output contact:	1 x NO-SPST (AgSnO <sub>2</sub> )	
Current rating:	12 A/AC1	
Max. breaking capacity:	3000 VA/AC1, 384 W/DC	
Peak current:	30 A/< 3 s	
Switched voltage:	250 V AC/24 V DC	
Mechanical life:	30.000.000 operations	
Electrical life:	70.000 operations	
<b>Other information</b>		
Operation temperature:	-30 °C to 65 °C (-22 °F to 149 °F)	
Storing temperature:	-30 °C to 70 °C (-22 °F to 158 °F)	
Dielectrical strenght:	4 kV (supply-output)	
Operation position:	sensor-side down	
Protection degree:	IP65	
Overvoltage cathegory:	III.	
Pollution degree:	2	
Max. cable size (mm <sup>2</sup> ):	max.1x 2.5, max. 2x 1.5/ with sleeve max.1x 2.5 (AWG 12)	
Suggested power-supply cable:	CYKY 3x2.5 (CYKY 4x1.5)	
Dimensions:	153 x 62 x 34 mm (6" x 2.4" x 1")	
Weight:	123 g (4.3 oz.)	
Standards:	EN 60255-1, EN 60255-26, EN 60255-27, IEC 60730-2-9	

### Function

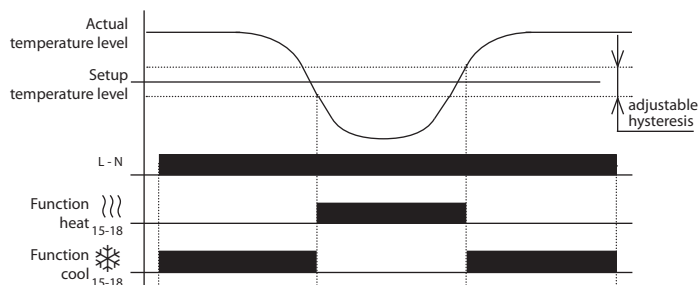

- Single point thermostat for monitoring and regulation of temperature in demanding environments (humid and contaminated, aggressive and defective, industrial workshops, washing rooms, green-houses, cellars and cooling boxes,...).
- External version in IP65, box for mounting on the wall.
- Built-in thermo-sensor is integrated in the device.
- Two functions adjustable by jumper: heating and cooling.
- 3 adjustable (by jumper) ranges of temperature, and fine adjustment through potentiometer.
- 3 adjustable (by jumper) levels of hysteresis.
- Potentialless NO-SPST contact 12 A AC1 switching.

### Description

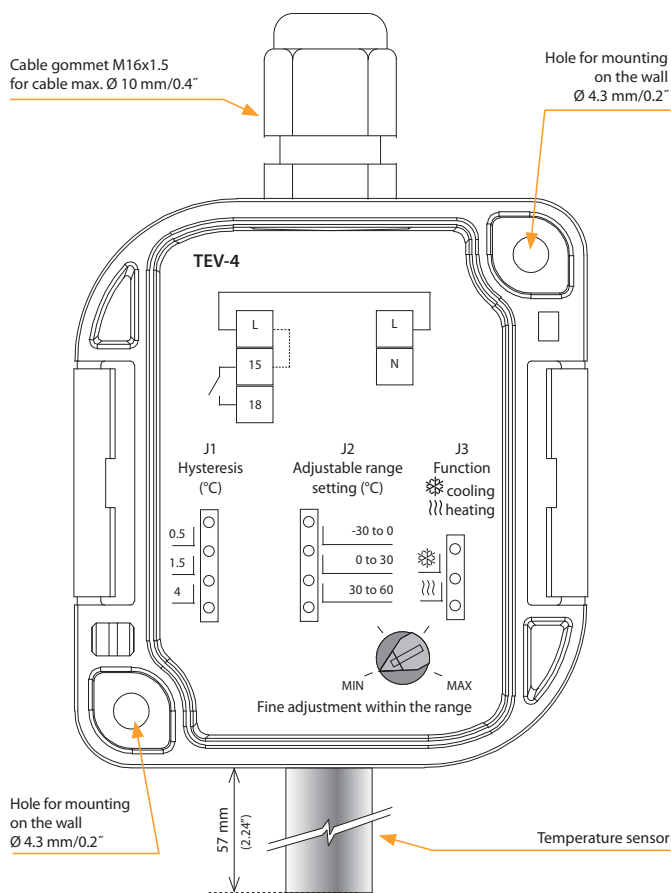

### Connection

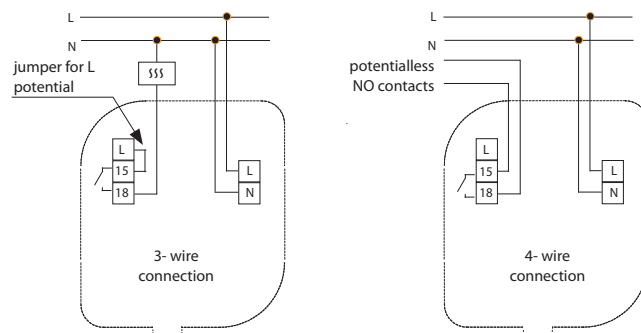

### Description of function

Device is standardly supplied with jumper L-15 (3-wire connection). For the correct function of device is necessary sensor-side down device mounting.



EAN code  
RHT-1: 8595188137263

Technical parameters		RHT-1
Function:	hygro-thermostat	
Supply terminals:	A1 - A2	
Voltage range:	24 - 240 V AC/DC (AC 50/60 Hz)	
Input:	max. 1 VA/0.5 W	
Max. dissipated power (Un + terminals):	2.5 W	
Tolerance of voltage range:	-15 %; +10 %	
Measuring circuit		
Temperature range:	0 °C to 60 °C (32 °F to 140 °F)	
Humidity range:	50 až 90 %	
Temperature hysteresis:	2.5 °C (4.5 °F)	
Humidity hysteresis:	4 %	
Sensor:	internal	
Indication of sensor's fault:	red LED flashing	
Accuracy		
Setting accuracy (mechanical):	5 %	
Long-term stability of humidity:	typical < 0.8 %/year	
Output		
Number of contacts:	1x NO-SPST (AgSnO <sub>2</sub> )	
Current rating:	16 A/AC1, 10 A/24 V DC	
Switched output:	4000 VA/AC1, 300 W/DC	
Switched voltage:	250 V AC/24 V DC	
Output indication:	red LED shines	
Mechanical life:	30.000.000 operations	
Electrical life:	70.000 operations	
Other information		
Operational temperature:	-20 °C to 60 °C (-4 °F to 140 °F)	
Storing temperature:	-30 °C to 70 °C (-22 °F to 158 °F)	
Dielectrical strength:	2.5 kV (supply-output)	
Operational position:	vertical, with correct orientation	
Mounting:	DIN rail EN 60715	
Protection degree:	IP40 from front panel, IP10 on terminals	
Overvoltage category:	III.	
Pollution degree:	2	
Max. cable size (mm <sup>2</sup> ):	max. 2x 2.5, max. 1x 4 with sleeve max. 1x 2.5, max. 2x 1.5 (AWG 12)	
Dimensions:	90 x 17.6 x 64 mm (3.5" x 0.7" x 2.5")	
Weight:	63 g (2.2 oz.)	
Standards:	EN 60255-1, EN 60255-26, EN 60255-27, IEC 60730-2-9	

- Hygro-thermostat for temperature monitoring and regulation in range 0 °C to 60 °C (32 °F to 140 °F) and relative humidity monitoring and regulation in range 50 to 90 %.
- Possibility of setting of up to 8 conditions for contact switching and function permanently ON/OFF.
- Sensor is a part of the device - designated for measuring in switchboards.
- Function of sensor control (damage, disturbances,...).
- Fixed setting of temperature hysteresis at 2.5 °C (4.5 °F) and humidity at 4 %.

Device description

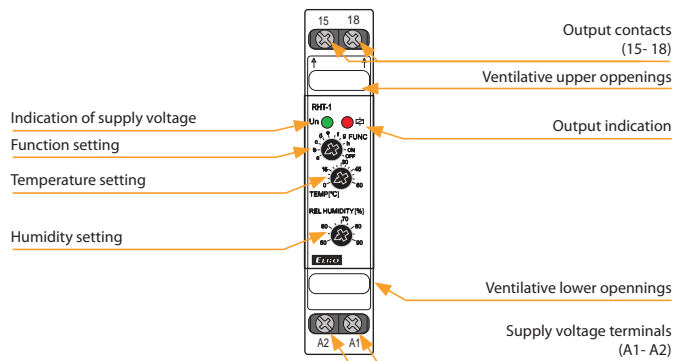

Funcions

Choice of function	Relay switched under the following conditions	
A	T > Tset	or RH > RHset
B	T < Tset	or RH > RHset
C	T > Tset	or RH < RHset
D	T < Tset	or RH < RHset
E	T < Tset	and RH < RHset
F	T > Tset	and RH < RHset
G	T < Tset	and RH > RHset
H	T > Tset	and RH > RHset
ON	relay permanently ON	
OFF	relay permanently OFF	

This device is designated for monitoring of parameters of environment (meaning temperature and relative humidity) in switchboards. It enables setting of eight conditions of constact closing and therefore it is usable for various types of load (e.g. fans, heating, air-conditioning, dehydrating units,...).

While installing it is necessary to take into account the fact that hysteresis rises by persistence of measured values between sensor and ambient environment.

The device is equipped by sensor fault detection. In case of sensor fault, exceeding allowed limits (for temperature -30 °C/-22 °F and +80 °C/176 °F; for humidity 5 % and 95 %) or in case of faulty internal communication higher than 50 % (due to e.g. high ambient disturbances) contact opens and sensor fault is indicated. Sensor fault doesn't have influence on function permanently ON or permanently OFF.

Note: In case the conditions for switching are not applied, relay is open.

Symbol

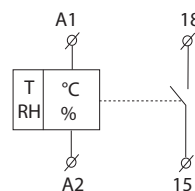

Connection





EAN code  
RHV-1: 8595188140584

Technical parameters		RHV-1
<b>Supply</b>		
Supply terminals:	L - N	
Voltage range:	AC 230 V (50/60 Hz)	
Input (apparent/loss):	max. 6 VA/0.7 W	
Max. dissipated power:	2.5 W (Un + terminals)	
Input voltage range:	- 15 % to +10 %	
<b>Setting function</b> Setting function Jumper J3		
Function - ●:	moistening	
Function - ☀:	drying	
<b>Set. the scale of relative humidity</b> Humidity setting Jumper J2		
range 1:	0 to 30 % RH	
range 2:	30 to 60 % RH	
range 3:	60 to 90 % RH	
Slight setting of relative humidity:	Relative Humidity Setting Potentiometer	
<b>Hysteresis</b> 2, 3, 4 % from setup rate		
Hysteresis setting:	Jumper J1	
<b>Output</b>		
Output contact:	1x NO-SPST (AgSnO <sub>2</sub> )	
Current rating:	12 A/AC1	
Switching output:	3000 VA/AC1, 384 W/DC	
Peak current:	30 A/< 3 s	
Switched voltage:	250 V AC/24 V DC	
Mechanical life:	30.000.000 operations	
Electrical life:	70.000 operations	
<b>Other information</b>		
Operation temperature:	-30 °C to 60 °C (-22 °F to 140 °F)	
Storing temperature:	-30 °C to 70 °C (-22 °F to 158 °F)	
Electrical strength:	4 kV (supply-output)	
Operation position:	sensor-side down	
Protection degree:	IP65	
Overvoltage category:	III.	
Pollution degree:	2	
Max. cable size (mm <sup>2</sup> ):	max. 1x 2.5, max. 2x 1.5/ with sleeve max. 1x 2.5 (AWG 12)	
Suggested power-supply cable:	CYKY 3x2.5 (CYKY 4x1.5)	
Dimensions:	153 x 62 x 34 mm (6" x 2.4" x 1.3")	
Weight:	124 g (4.4 oz.)	
Standards:	EN 60255-1, EN 60255-26, EN 60255-27, IEC 60730-2-9	

- Single hygrostat is used for regulation of humidity in harsh environments (washdown, greenhouse, refrigeration).
- External version in IP65, box for mounting on the wall.
- Built-in hygro-sensor is integrated in the device.
- Two functions adjustable by jumper: moistening and drying.
- 3 adjustable (by jumper) levels of hysteresis.

**Description**

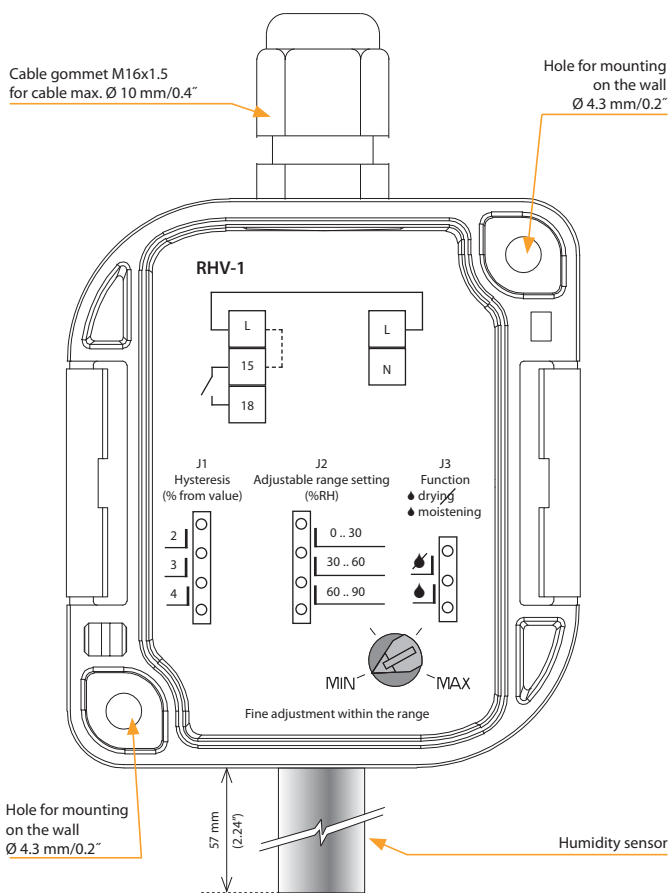

**Connection**

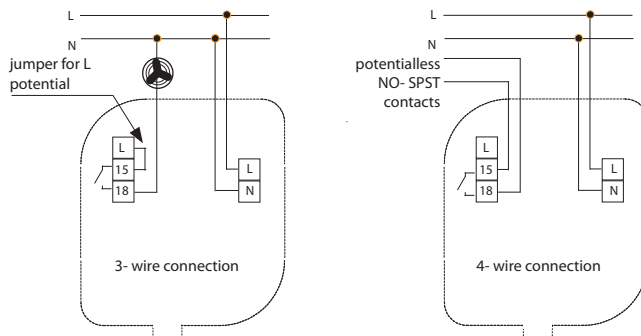

**Description of function**

Device is supplied with a standard jumper. For the device to operate correctly, it must be mounted with the sensor side down.

**Function**

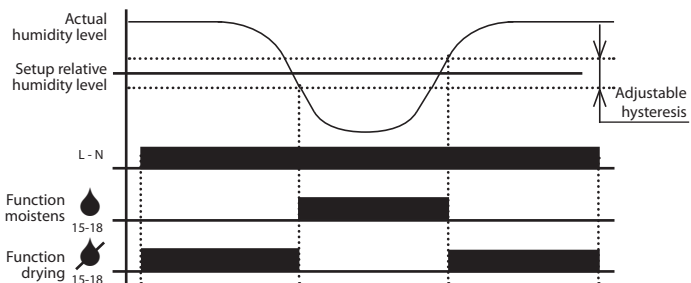



EAN code 8595188160889  
 ATV-1:  
 USB programming adapter:  
 8595188160995

Technical parameters		ATV-1
Operating voltage:	3 V/DC (2 AA batteries 1.5 V/DC AA)	
Temperature range:	8 to 28 °C (46 to 82 °F)	
Color:	white	
Dimensions (L x W x H):	76.5 x 53.5 x 63 mm (3" x 2.1" x 2.4")	
Design:	thermostatic direction valves, electronic	

- This energy-saving digital thermo-valve is a programmable regulation device for various heaters, but mainly radiators.
- It can be used to regulate temperature in closed rooms, thus helping to lower heat energy consumption.
- Functions:
  - manual mode - measuring and checking a manually set temperature
  - automatic mode - control between two temperatures based on a set time program:
    - Comfort temperature (factory settings 21 °C/70 °F).
    - Energy-saving temperature (factory settings 16 °C/61 °F).
- Intervals of heating and energy-saving operation can be set using a freely adjustable time program.
  - 8 individually programmable switching times per day:
    - 4 heating intervals.
    - 4 energy-saving intervals.
- The device features very quiet operation and long battery life (up to 5 years).
- Quick and easy installation.

Examples of daily heating program

LIVING ROOM

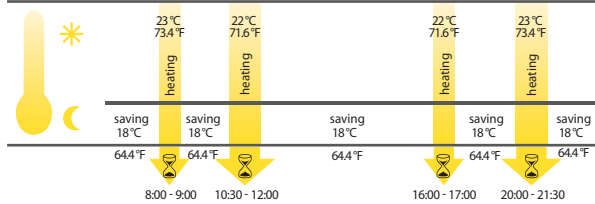

BATHROOM

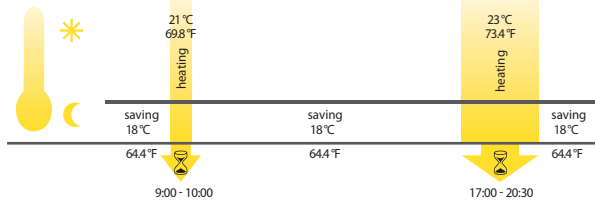

Description of device

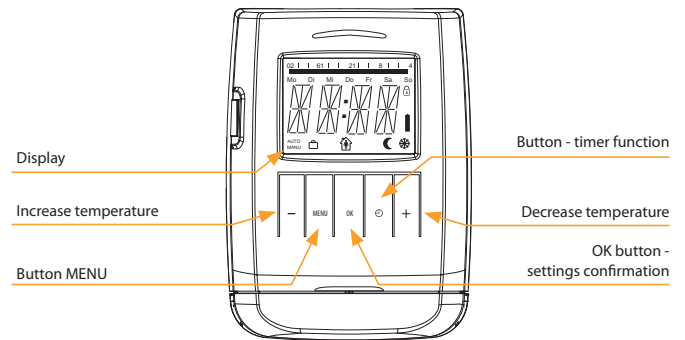

Other functions

1. Time function - the desired temperature can be set for a certain adjustable time interval.
2. Vacation function - while you're gone, you can set and maintain the desired temperature.
3. Open window function - when the temperature drops, the heating valve automatically closes in order to save energy.
4. Child safety block - blocking against undesired interference with the thermostat.
5. Freeze protection - if the temperature drops below 6 °C (43 °F), the valve opens until the temperature again exceeds 8 °C (46 °F). This keeps heaters from freezing.

Adjustment ATV-1

- manual
  - via USB programming adapter PROGmatic
- Using the programming port, in seconds your settings will be transferred into the thermostat.



Adapters	
Type of valve	Type of adapter
Heimeier, Junkers Landys+Gyr, MNG, Honeywell, Braukmann thread size M 30x1.5	No adapter necessary + enclosed pin; only for RAV
Danfoss RAV (the valve plunger must be fitted with the enclosed pin)	
Danfoss RA	
Danfoss RAVL	



EAN code  
 TELVA-2 230 V, NO: 8595188181969  
 TELVA-2 230V, NC: 8595188181976  
 TELVA-2 240 V, NO: 8595188181983  
 TELVA-2 240 V, NC: 8595188181990

Technical parameters	TELVA - 2 230V		TELVA- 2 24V	
	NO	NC	NO	NC
Operating voltage:	230 V (50/60 Hz)		24 V (50/60 Hz)	
Switching current max:	300 mA		500 mA	
Operating current:	13 mA		100 mA	
Closing/opening time:	3-5 min		3-5 min	
Power input:	2.9 W		2.4 W	
Protection:	IP54		IP54	
Settings:	4 mm (0.16")		4 mm (0.16")	
Stopping force:	90-110 N		90-110 N	
Cable length:	800-1000 mm (31 - 39")		800-1000 mm (31 - 39")	
Connecting wire:	2 x 0.75 mm <sup>2</sup>		2 x 0.75 mm <sup>2</sup>	
Media temperature	-5°C to 60 °C (23 to 140 °F)		-5°C to 60 °C (23 to 140 °F)	
Colour:	white RAL 9003		white RAL 9003	
Dimensions h/w/d:	63 x 42 x 45 mm (2.5 x 1.7 x 1.8")		63 x 42 x 45 mm (2.5 x 1.7 x 1.8")	
Connection size:	M30 x 1.5 mm (1.2" x 0.06")		M30 x 1.5 mm (1.2" x 0.06")	

- Thermodrive is intended for opening or closing valves in heating, cooling or air conditioning systems. It is also suitable for use in a floor heating or ceiling cooling manifolds.
- Available in NO (open without voltage), NC (closed without voltage) and for 230V and 24V.
- The internal principle of operation of the thermo drive mechanism = its movement so that the valve opens/closes is provided by an electric heating element with expansion material, which expands due to temperature changes in the supply voltage.
- The thermodrive is maintenance-free and works completely silently.
- The thermodrive is fitted with a metal nut M30 x 1.5, thanks to which it becomes a 100% fixed part of the valve with this corresponding thread size after installation.
- The stated nut size predetermines the use of a thermocouple with valves from manufacturers such as Herz, HoneyWell, Danfoss, Oventrop and others.

- Telva thermodrive:
  - is characterized by absolutely quiet and maintenance-free operation
  - is designed for installation - control of heating and cooling systems
  - method of mounting the actuator on the controlled valve using an M30 x 1.5 nut
  - any working position.
- Type of use:
  - Underfloor heating - the RFTC-50/G wireless controller measures the room temperature and, based on the set program, sends a command to the RFSA-66M switching element to open/close the TELVA thermo drive on the distributor.





EAN code			
TC-0:	8595188110075	TZ-0:	8595188140591
TC-3:	8595188110617	TZ-3:	8595188110600
TC-6:	8595188110082	TZ-6:	8595188110594
TC-12:	8595188110099	TZ-12:	8595188110587
		Pt100-3:	8595188136136
		Pt100-6:	8595188136143
		Pt100-12:	8595188136150

Technical parameters	TC	TZ	Pt100
Range:	-20 °C to +80 °C (-4 °F to 176 °F)	-40 °C to +125 °C (-40 °F to 257 °F)	-30 °C to +200 °C (-22 °F to 392 °F)
Scanning element:	NTC 12K	NTC 12K	Pt100
Tolerance:	±(0.15°C + 0.002[t])	±(0.15°C + 0.002[t])	±(0.3°C + 0.005[t])
In air/in water:	(τ0.5) ≤ 18 s	(τ65) 62 s/8 s	(τ0.5) - /7 s
In air/in water:	(τ0.9) ≤ 48 s	(τ95) 216 s/23 s	(τ0.9) - /19 s
Cable material:	PVC unshielded, 2 x 0.25 mm <sup>2</sup>	PVC	shielded silicone 2 x 0.22 mm <sup>2</sup>
Terminal material:	polyamide	stainless steel	Copper
Protection degree:	IP67	IP67	IP67
Electrical strength:	2500 VAC	2500 VAC	2500 VAC
Insulation resistance:	> 200 MΩ at 500 VDC	> 200 MΩ at 500 VDC	> 200 MΩ at 500 VDC

Types of temperature sensors			
	TC-0	TZ-0	-
Length:	100 mm	110 mm	-
Weight:	5 g	4.5 g	-
	TC-3	TZ-3	Pt100-3
Length:	3 m	3 m	3 m
Weight:	70 g	106 g	68 g
	TC-6	TZ-6	Pt100-6
Length:	6 m	6 m	6 m
Weight:	130 g	216 g	149 g
	TC-12	TZ-12	Pt100-12
Length:	12 m	12 m	12 m
Weight:	250 g	418 g	249 g

τ65 (95): time, which sensor needs to heat up on 65 (95) % of ambient temperature of environment, in which is located.

- Thermister temperature sensors are made of Negative Temperature Coefficient (NTC) embedded in a PVC or metal sleeve with a thermally-conductive sealer.
- **Sensor TC**
  - lead-in cable to sensor TC is made of wire CYSY 2D x 0.5 mm/0.02".
- **Sensor TZ**
  - cable VO3SS-F 2D x 0.5 mm/0.02" with silicone insulation for use in high temperature applications
  - silicone insulation for use in high temperature applications.
- **Sensor Pt100**
  - shielded silicon 2x 0.22 mm<sup>2</sup> (AWG 21), shielding connected with a case.
- Temperature sensors can be connected directly to the terminal block.
- Cable lengths can not be changed, connected or modified.

Resistive values of sensors in dependance on temperature

Temperature (°C/°F)	Sensor NTC (kΩ)	Sensor Pt100 (Ω)
20 /68	14.7	107.8
30 /86	9.8	111.7
40 /104	6.6	115.5
50 /122	4.6	119.4
60 /140	3.2	123.2
70 /158	2.3	127.1

Tolerance of sensor NTC 12 kΩ is ± 5 % by 25 °C/77 °F.

Long-term resistance stability by sensor Pt100 is 0.05 % (10 000 hours).

Diagramm of sensor warm up via air

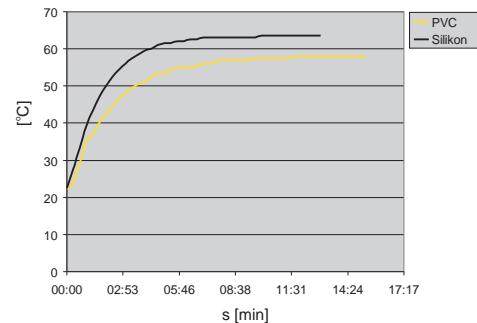

PVC - reaction to water temperature from 22.5 °C to 58 °C (from 72.5 °F to 136.4 °F).

Silicone - reaction to water temperature from 22.5 °C to 63.5 °C (from 72.5 °F to 144.5 °F).



If you are interested in our products, visit one of our free professional trainings in the Czech Republic

All trainings at: [www.elkoep.com/trainings-and-exhibitions](http://www.elkoep.com/trainings-and-exhibitions)

## Technical support

In case of technical questions, contact our technical support by phone or email:



**+420 770 177 028**  
**[balla@elkoep.com](mailto:balla@elkoep.com)**



**+420 800 100 671**  
**[support@elkoep.com](mailto:support@elkoep.com)**

Alternatively, you can contact us using the contact form on our website:  
[www.elkoep.com/tech-support](http://www.elkoep.com/tech-support)



To ensure correct and perfect function of a device and its safe operation, it is necessary to ensure and observe several main regulations:

**1. Device supply**

- it is necessary to ensure continuous supply of the device without drops and voltage peaks. It is mainly important for device (e.g. dimmers) where there is synchronization managed by sine wave of the main and fault in the main ca cause unreliable function of the device
- it is necessary to observe correct connection of terminals, and in case of DC supply voltage also polarity
- it is necessary to observe allowed tolerance of the size of supply voltage which is given by technical parameters of individual devices

**2. Protection of the device**

- it is necessary to ensure protection of the device by adequate elements of overvoltage protection – by fuses, by surge arrestors

**3. Elimination of disturbances on input circuits**

- it is recommended to eliminate disturbances on control inputs of devices by suitable elements (R-C elements) and thus minimize creation of inductive voltage on incoming wires
- pay attention when connecting control inputs and keep in mind max. current and min. voltage at rest, which can cause spontaneous switching of device (e.g. connected glow lamps)

**4. Operating conditions**

- to assure the granted life and correct functions of device, there is not recommended to leave the device in extreme conditions that could negative way influence the correct device functions - permanent temperature influence over 70°C, aggressive exhalations, chemicals, high relative humidity over 95%, high electromagnetic field or microwave radiation
- for error-free function it is necessary to avoid device placement close to electromagnetic interference source
- all mentioned products fulfill the EMC requirements in accordance with EU Directive 89/336/EEC. Notwithstanding it is necessary to pay attention when devices are connected to circuit with electrical appliances that produce electromagnetic interference (contactors, motors), and pay attention to close power cables. It is recommended that device connecting cables (supply and control inputs) are possibly short and go separately from power cables. In case the device is connected to circuit with contactors or motors, it is necessary to protect the device with appropriate extern protection components - RC members, varistors or surge voltage protector.
- when you use AL wires, it is necessary to follow requirements of ČSN standard 370606: 1959 and ČSN 370606 amendment 2: 1992

**5. Device handling and using**

- input terminals do not fill-in with high power (for serial terminals max 0.5 N/m), do not give excessive pressure to carrier terminal parts to avoid damage of inner device construction
- protect the device before falls and excessive vibrations that could damage relays contacts
- do not overload input relay's contacts, especially when using loads with other category then AC1
- when at switching of big loads the relay contacts get sealed it is necessary to use inserted contactor or power relay tuned to required load for given application

Description of used protection elements in device

All time and monitoring relays from our assortment are equipped with protective elements (varistors) against possible overvoltage in supply main. Limit voltage of used varistors is 275 V. At short-time overvoltage in supply main varistor decrease its leak resistor and accumulate arisen overvoltage. When this overvoltage behave as short-time peak, varistor is able to react and protect the device against negative influences. As other protection elements there are used transils and zener diodes that eliminate overvoltage impulses in supply and input circuits of device (e.g. when switching inductive loads). In case of switching inductive loads it is recommended to separate a supply of power element (motors, contactors etc.) from supply of measuring and control device inputs.

On the charts bellow you can see oscilographic running of disconnecting of loads (contactors) and reaction of protective elements to arisen voltage pikes.

Process of disconnection of contactor with coil on 230V/AC without R-C member

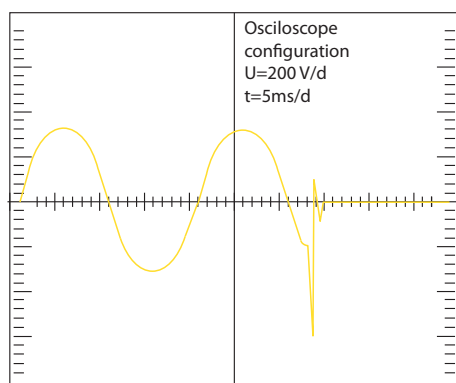



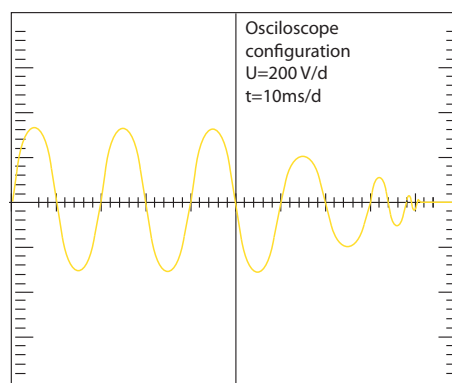



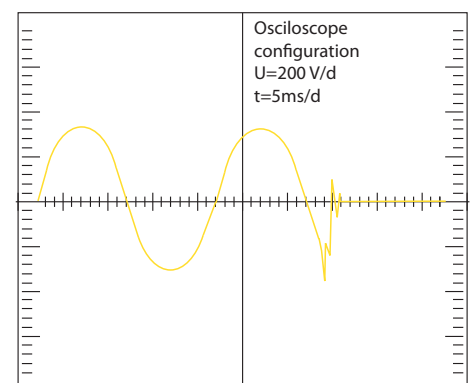











Process of disconnection of contactor with coil on 230V/AC and R-C member 390 Ohm-330 nF



Process of disconnection of contactor with coil and limited varistor on 230V/AC



PRODUCT	SOU-2	RHV-1; SOU-3; TEV-4	CRM-4; CRM-46; HRH-7; MR-41; MR-42; SHT-1; SHT-1/2; SHT-3; SHT-3/2; SHT-4; SHT-6; SMR-B; SOU-1; RHT-1; TER-3A; TER-3B; TER- 3C; TER-3D; TER-3E; TER-3F; TER-3G; TER-3H ; VS116K; VS116U; VS316/24V; VS316/230V	CRM-82TO; CRM-83J; CRM-93H; TER-7; VS308K; VS308U; CRM-61; HRH-5; HRN-54; HRN-54N; HRN-55; HRN-55N; HRN-56; HRN-57; HRN-57N; PRI-32; PRI-51; PRI-52; PRI-53; HRF-10; TER-9	HRH-6	COS-2; CRM-2H; CRM-2HE; CRM-2T; CRM-81J; CRM-91H; CRM-91HE; HRH-1; HRN-33; HRN-34; HRN-35; HRN-37; HRN-41; HRN-42; HRN-43; HRN-43N; HRN-63; HRN-64; HRN-67; PDR-2; PRI-41; PRI-42; PRM-91H; SJR-2; TER-4; TEV-1; TEV-2; TEV-3
CONTACT	Material of contact AgSnO <sub>2</sub> contact 8A	Material of contact AgSnO <sub>2</sub> contact 12A	Material of contact AgSnO <sub>2</sub> contact 16A	Material of contact AgNi contact 8A	Material of contact AgNi contact 10A	Material of contact AgNi contact 16A
TYPE OF LOAD						
 AC1 cos φ ≥ 0.95	250V / 8A	250V/12A	250V/16A	250V/8A	250V/10A	250V/16A
 AC2	250V / 5A	250V/3.7A	250V/5A	250V/3A	250V/3A	250V/5A
 AC3	250V /4A	250V/2.2A	250V/3A	250V/2A	250V/2A	250V/3A
 AC5a uncompensated	x	230V/2.2A (510VA)	230V/3A (690VA)	230V/1.5A (345VA)	230V/2A (460VA)	230V/3A (690VA)
 AC5a compensated	x	230V/2.2A (510VA) till max output C=14UF	230V/3A (690VA) till max output C=14UF	x	x	x
 AC5b	250W	1 120W	1000W	300W	500W	800W
 AC6a	250V /4A	x	x	x	x	x
 AC7b	250V /1A	250V/2.2A	250V/3A	250V/1A	250V/2A	250V/3A
 AC12	250V /1A	250V/7.5A	x	250V/1A	250V/6A	250V/10A
 AC13	x	250V/4.5A	x	x	250V/3.8A	250V/6A
 AC14	250V /4A	250V/4.5A	250V/6A	250V/3A	250V/3.8A	250V/6A
 AC15	250V /3A	250V/4.5A	250V/6A	250V/3A	250V/3.8A	250V/6A
 DC1	30V / 8A	24V/12A	24V/10A	24V/8A	24V/10A	24V/16A
 DC3	30V / 3A	24V/4.5A	24V/3A	24V/3A	24V/3.8A	24V/6A
 DC5	30V / 2A	24V/3A	24V/2A	24V/2A	24V/2.5A	24V/4A
 DC12	30V / 8A	24V/12A	24V/6A	24V/8A	24V/10A	24V/16A
 DC13	30V / 2A	24V/1.5A	24V/2A	24V/2A	24V/1.3A	24V/2A
 DC14	x	24V/1.5A	x	x	24V/1.3A	24V/2A

Problematic choice of suitable relay contact for a particular load switched with a product is described below. Mostly we experience problems with incorrect choice of load (meaning incorrect relay for a particular load) which results in permanent switching of contact (sealing) or damage on relay contact – which then results in malfunction. What load can you use? Detailed types of load according to standard EN 60947 are described in charts below – categories of use.

Category of use	Typical use	EN
AC current, $\cos\phi = P/S$ (-)		
AC-1	Non-inductive or slightly inductive load, resistance furnace Includes all appliances supplied by AC current with power factor ( $\cos \phi$ ) $\geq 0.95$ Examples of usage: resistance furnace, industrial loads	60947-4
AC-2	Motors with slip-ring armature, switching off	60947
AC-3	Motors with short-circuit armature, motor switching when in operation This category applies to switching off motors with short-circuit armature while in operation. While switching, contactor switches current which is 5 up to 7 times rated current of motor.	60947-4
AC-4	Electro-motors with short-circuit armature: start up, braking by backset, changeover	60947
AC-5a	Switching of electrical gas-filled lights, fluorescent lights	60947-4
AC-5b	El. bulb switching Enables low contact loading due to resistance of cold fiber is many times smaller than the one of hot fiber.	60947-4
AC-6a	Switching of transformers	60947-4
AC-6b	Switching of capacitors	60947-4
AC-7a	Switching low inductive loads of home appliances and similar applications	60947
AC-7b	Load of motors for home appliances	60947
AC-8a	Switching of hermetically sealed motors of cooling compressors with manual reset switches against overload Hermetically sealed cooling compressors have to be placed in one box without external shaft or shaft padding and motor must operate with cooling liquid	60947
AC-8b	Switching of hermetically sealed motors of cooling compressors with manual reset switches against overload Hermetically sealed cooling compressors have to be placed in one box without external shaft or shaft padding and motor must operate with cooling liquid	60947
AC-12	Switching of semiconductor loads with separation transformers	60947-5
AC-13	Switching of semiconductor loads with separation transformers	60947-5-1
AC-14	Switching of low electro-magnetic loads (max.72 VA)	60947-5-1
AC-15	Management of alternating electro-magnetic loads This category applies to switching inductive loads with input for closed electro-magnetic circuit higher than 72 VA Use: switching coils of contactors	60947-5
AC-20	Connecting and disconnecting in unloaded states	60947-3
AC-21	Switching resistive loads, including low loading	60947-3
AC-22	Switching of mixed resistive and inductive loads, including low overloading	60947-3
AC-23	Switching of motor loads or other high inductive loads	60947-3
AC-53a	Switching of motors with short-circuit armature with semiconductor contactors	60947

Note: Category AC 15 replaces formerly used category AC 11

DC current,  $t = L/R$  (s)

DC-1	Non-inductive or low inductive load, resistive furnaces	60947-4
DC-3	Shunt motors: start-up, braking by backset, reversion, resistive braking	60947-4-1
DC-5	Series motor: start-up, braking by backset, reversion, resistive braking	60947-4-1
DC-6	Non-inductive or low inductive loads, resistive furnaces – el. bulbs	60947-4-1
DC-12	Management of resistive loads and fixed loads with insulation by opto-electric element	60947-5-1
DC-13	Switching of electromagnets	60947-5-1
DC-14	Switching of electromagnetic loads in circuits with limiting resistor	60947-5-1
DC-20a(b)	Switching and breaking without load(a: frequent switching ,b: occasional switching)	60947-3
DC-21a(b)	Switching ohmic loads including limiting overloading (a: frequent switching ,b: occasional switching)	60947-3
DC-22a(b)	Switching of compound ohmic and inductive loads including limited overloads (e.g. shunt motors) (a: frequent switching, b: random switching)	60947-3
DC-23	Switching of highly inductive loads (e.g. series motors)	60947-3

How can you distinguish for which load is our product (relay) designated?

Our company records this information on a products and also in our catalogue, instruction manual and other promotional and technical material (website etc.).

It is important to realize that it is not always possible to point out load because of lack of information about the device (user cannot measure  $\cos$ ) or it is not possible because of inconsistency of parameters of switched device. Manufacturer of relays records always guaranteed parameters in ideal conditions which are done by a norm (temperature, pressure, humidity, etc.) and reality can be in a lot of cases different. Category of use (classification) of a particular relay is done by material of output contacts.

Basic types of materials which are used for production of contacts for high-performance relay are:

- AgCd – suitable for switching ohmic loads. Before of harmfulness of Cd, this type of contact is remitted.
- AgNi – designated for switching resistive loads, good quality switching and conducting (contact doesn't oxidate) small currents/voltages, it is not designated for surge currents and loads with inductive component.
- AgSn or AgSnO<sub>2</sub> –suitable for switching loads with inductive component, not suitable for switching small currents/voltages, it is more resistive to surge currents, suitable for DC voltage switching, less suitable for switching loads of ohmic type.
- Wf (wolfram)-special contact designated for switching surge currents with inductive component.
- with gold (AgNi/Au)- Used for "improving" contacts for low currents/ voltages , prevents oxidation.

Packing of 1-MODULE relay - 1 pc



Packing of 1-MODULE relay - 10 pcs



Packing of 1-MODULE relay with accessories



Packing of 2-MODULE relay - 1 pc



Packing of 3-MODULE relay - 1 pc



1-MODULE DESIGN

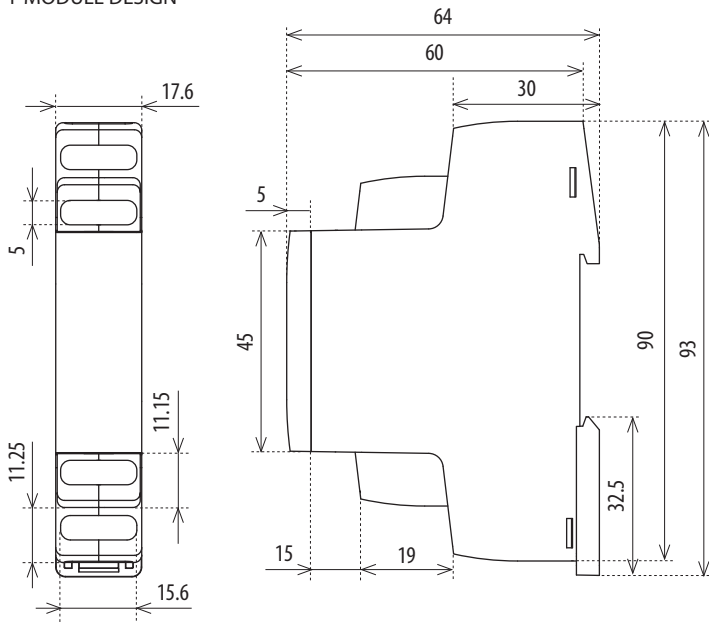

front panels 1-MODULE, examples of use:

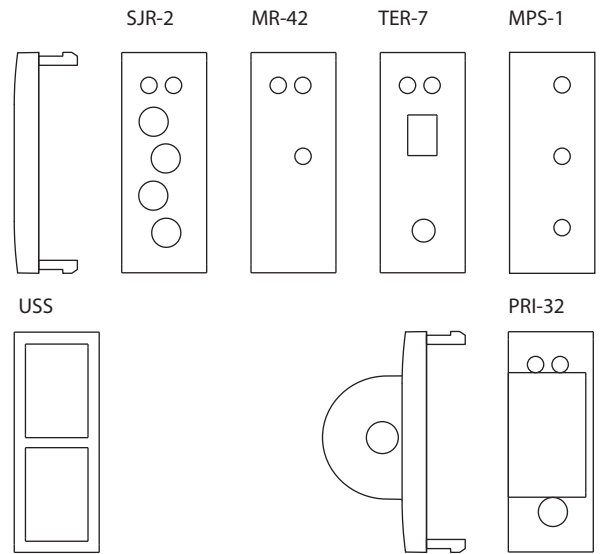

3-MODULE DESIGN

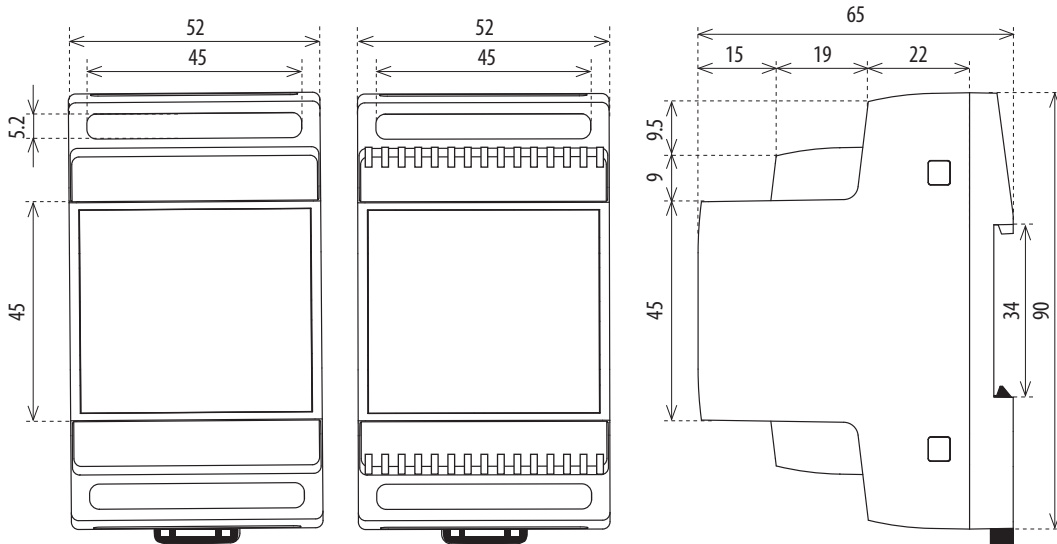

front panels 3-MODULE, examples of use:

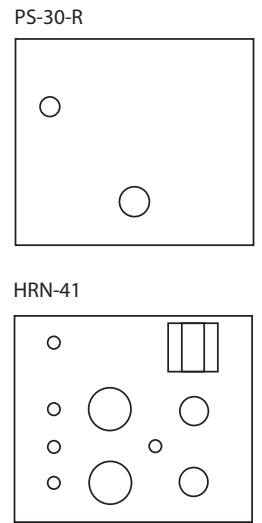

2-MODULE DESIGN

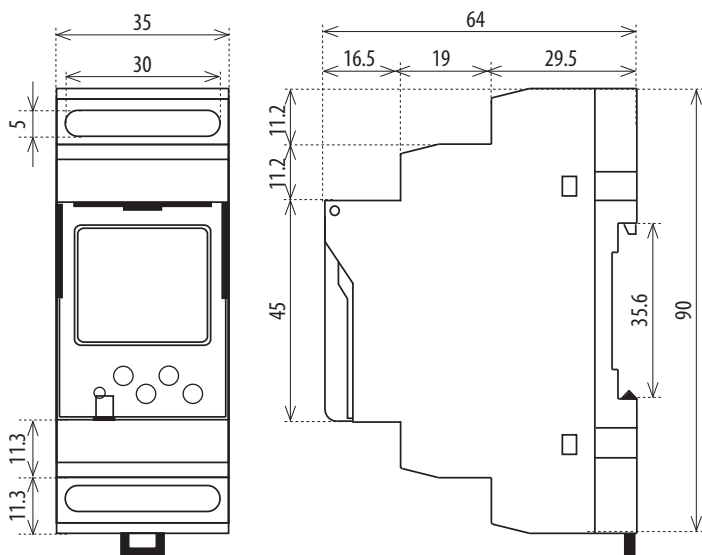

HRH-8

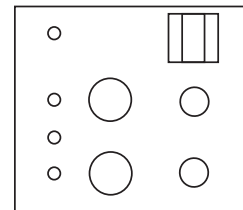

ZSR-30

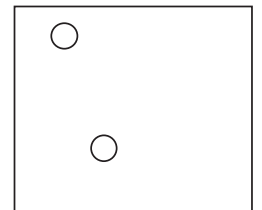

HRF-10

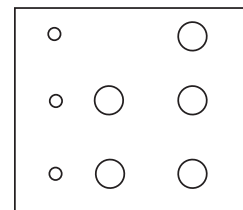

HRN-56

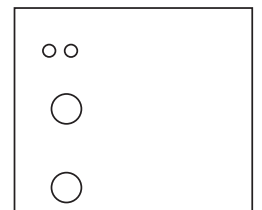

6-MODULE DESIGN

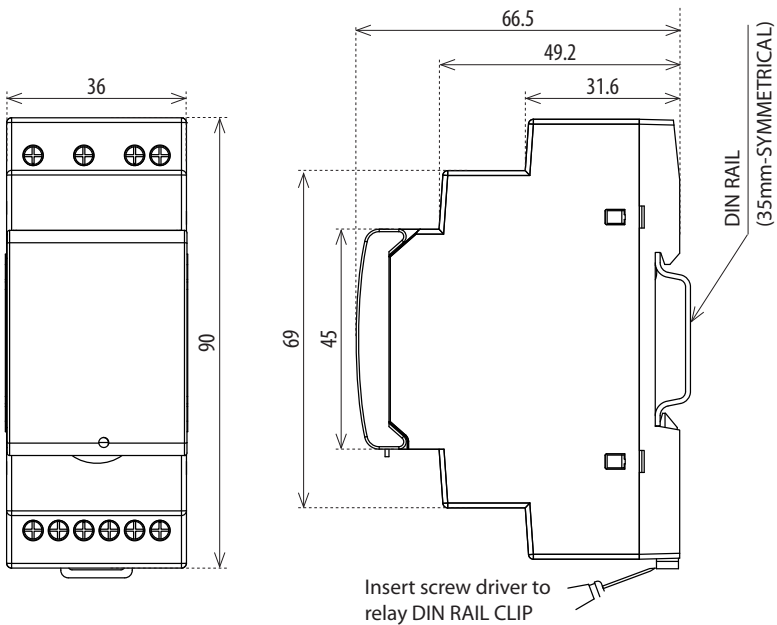
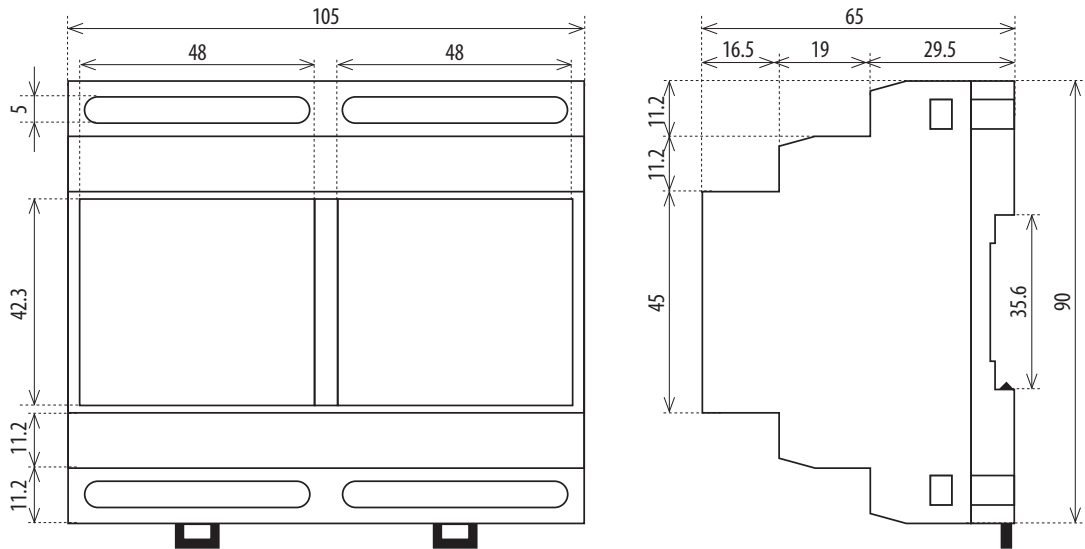

SMR-T, SMR-H, SMT-K

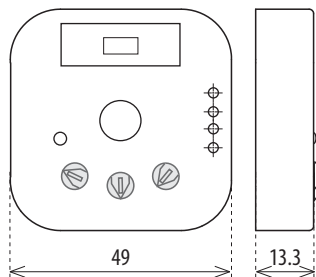

SMR-S

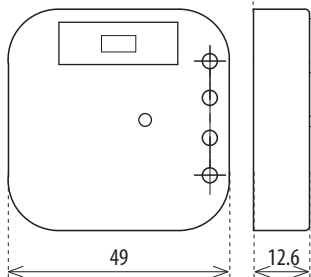

SMR-B

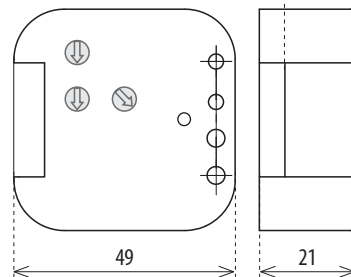

VS116/B

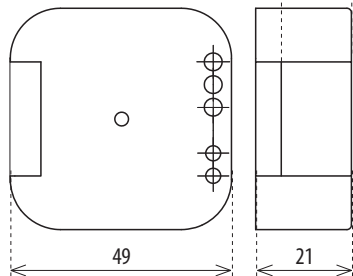

SMR-M

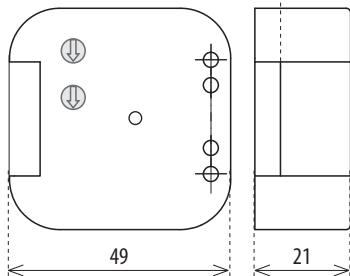

PSB

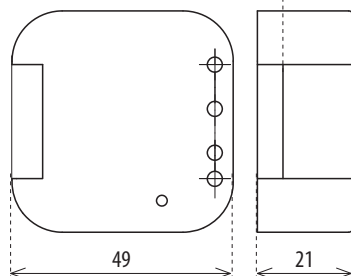



RHV-1, TEV-4

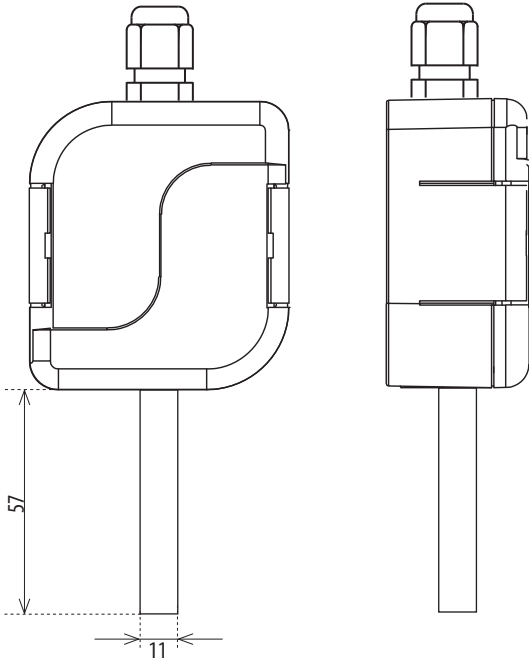

SOU-3

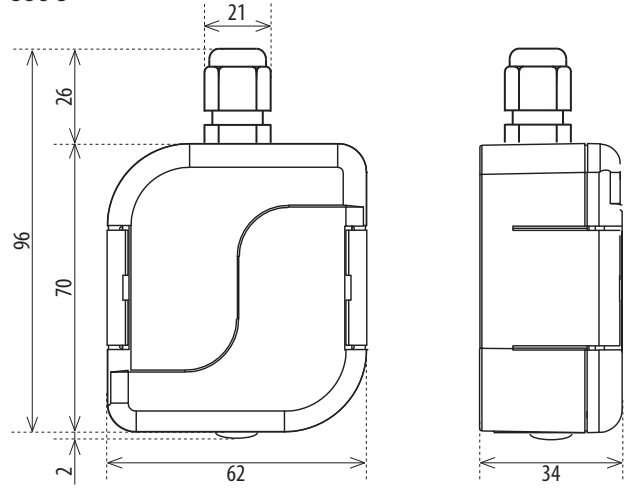

USS

Unit: 00

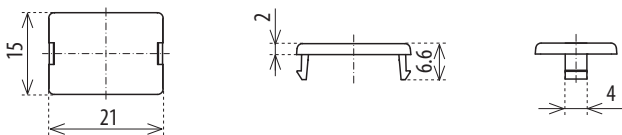

Unit: 01

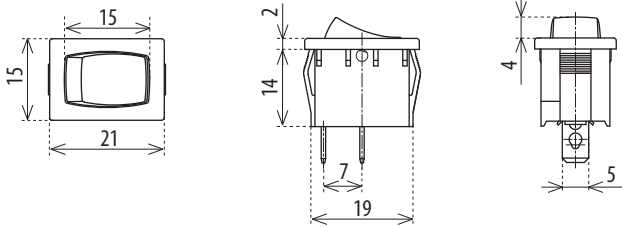

Unit: 02, 06, 07, 08, 09

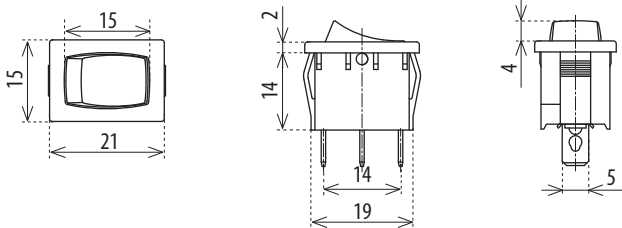

Unit: 03, 04, 05

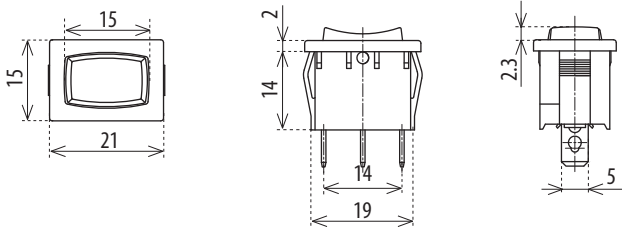

Unit: 10, 11, 12, 12, 13, 14, 15

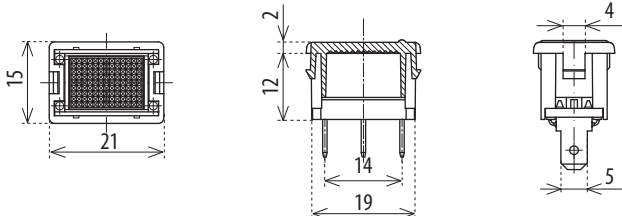

Temperature sensors

TC

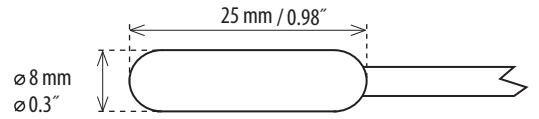

TZ

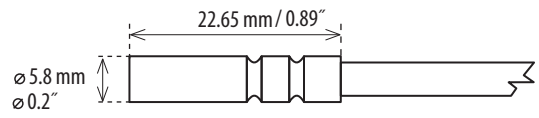

Pt100

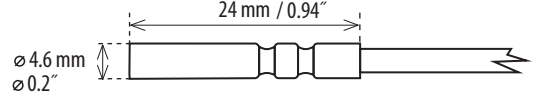

photosensor SKS-100

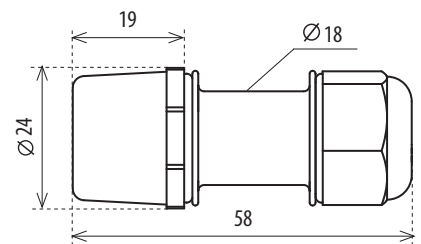

external potentiometer for CRM-2HE, CRM-91HE

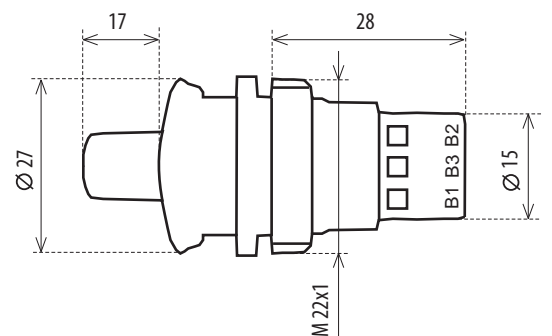

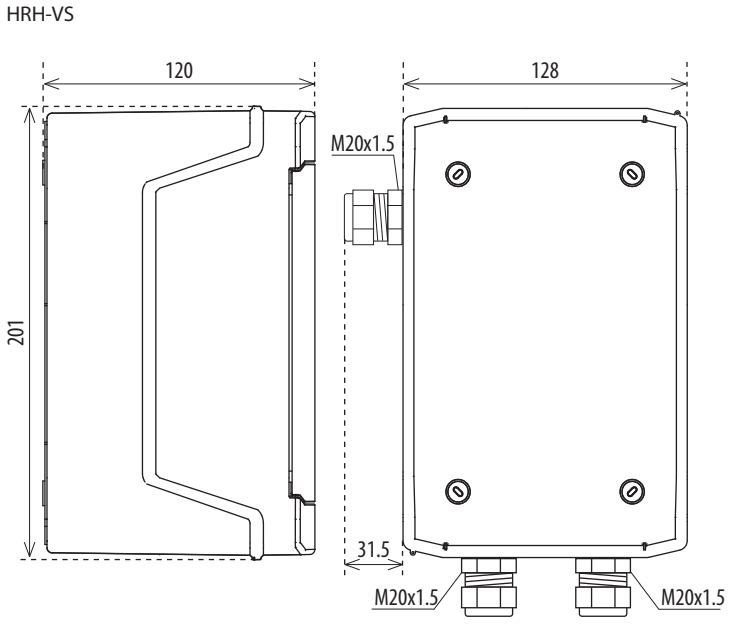
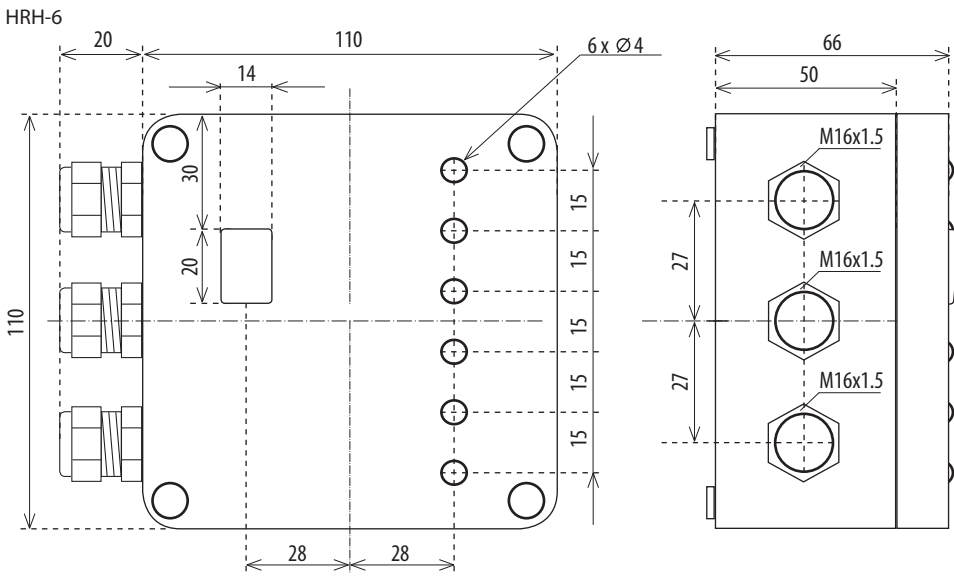

front panels 6-MODULE, examples of use:

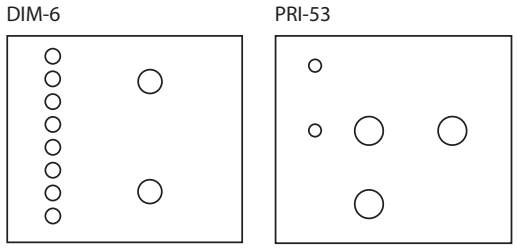

Level sensor

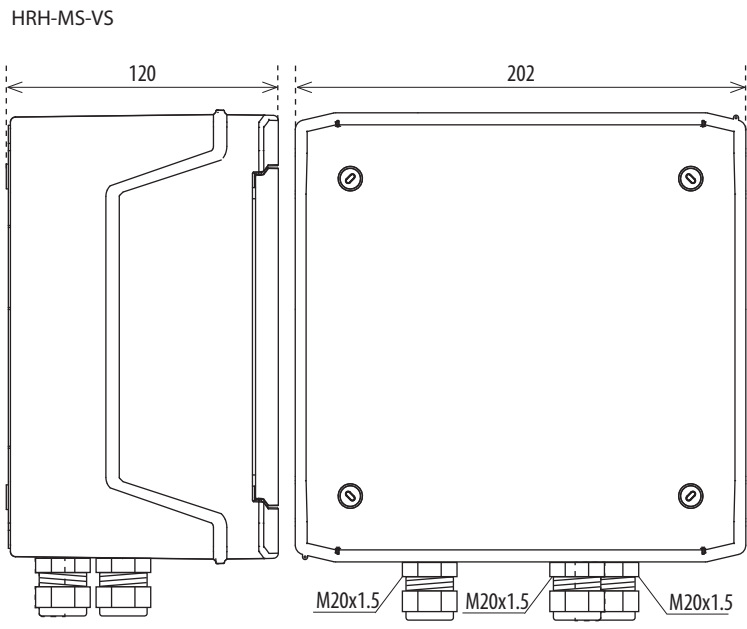
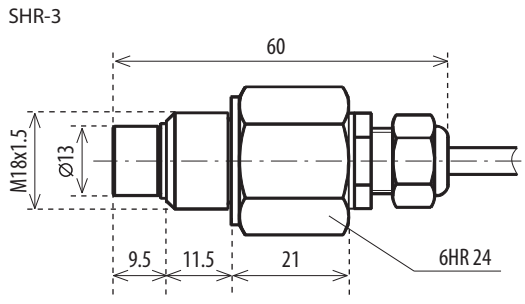
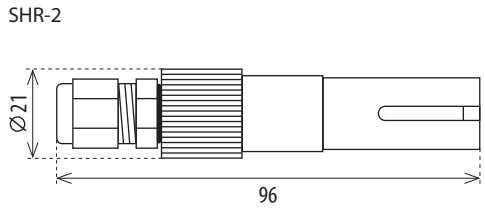
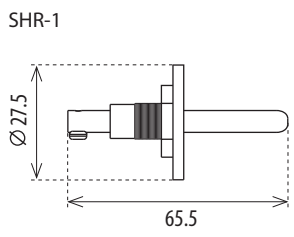

TEV-1, TEV-2

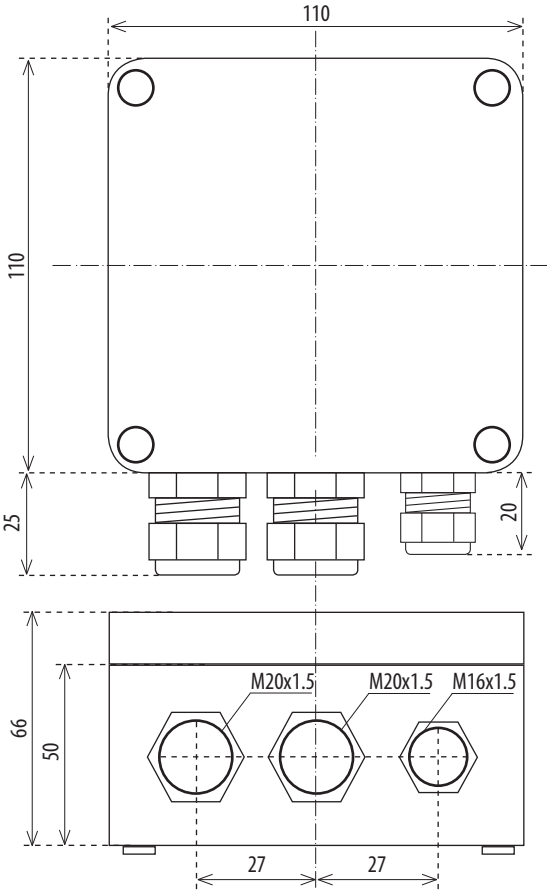

TEV-3

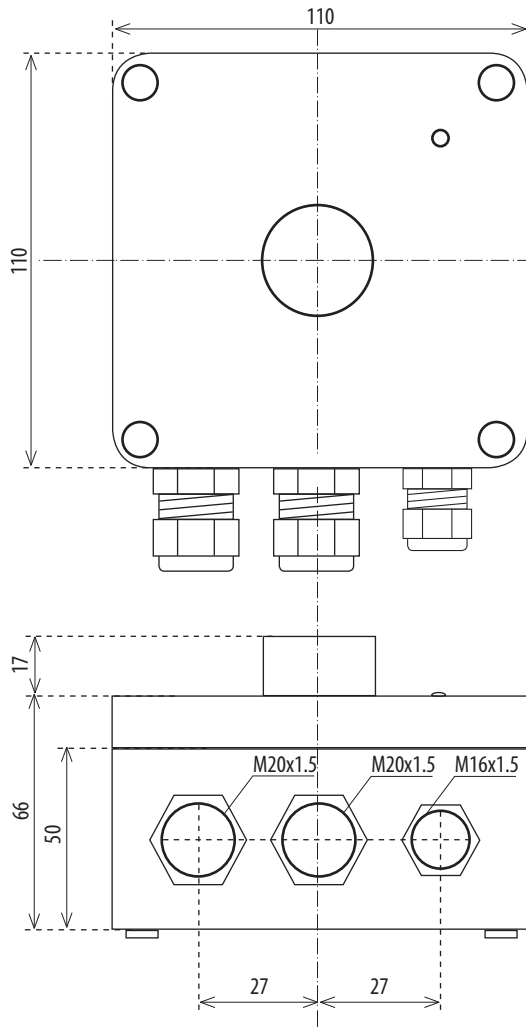

HRH-7

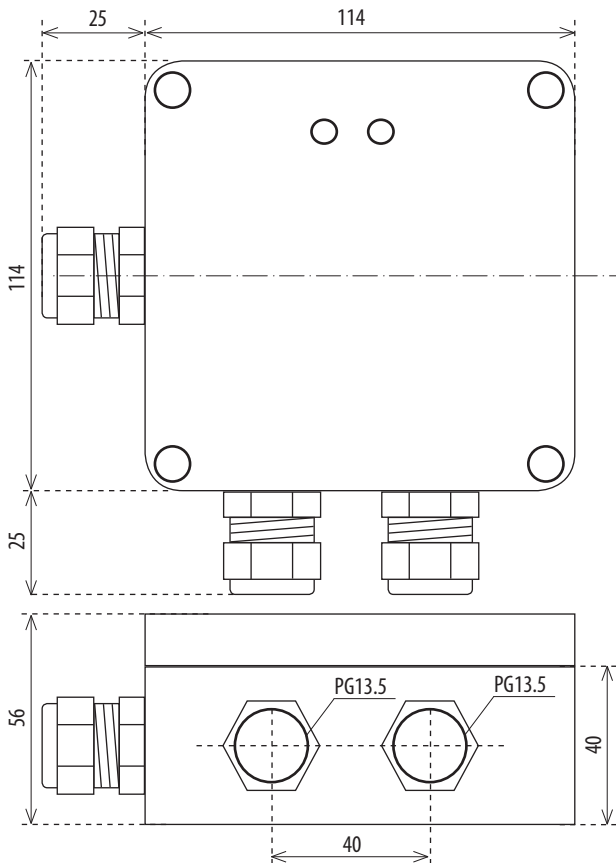

ATV-1

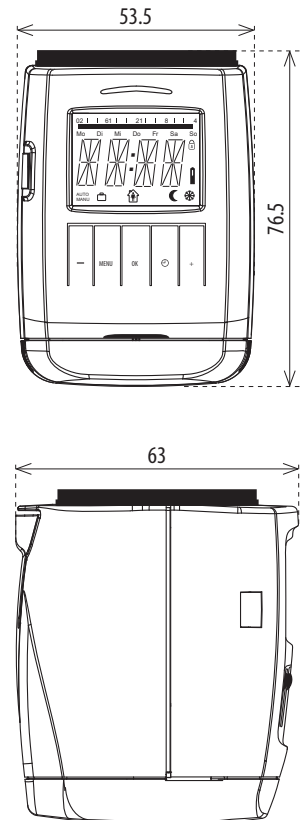

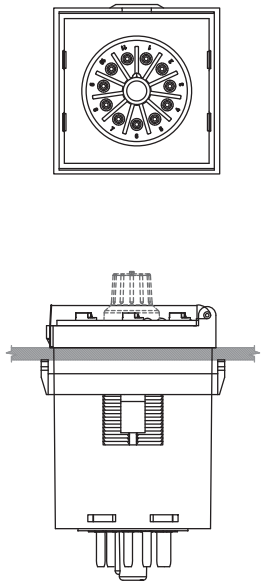
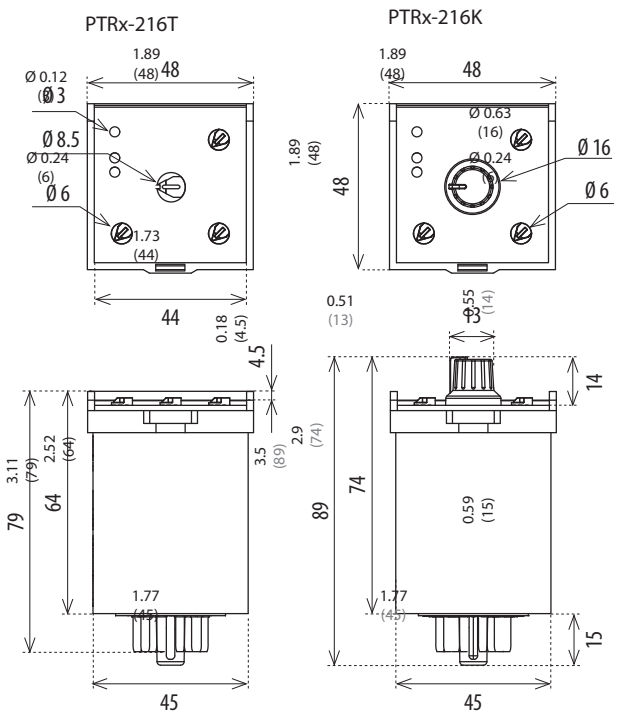

Socket for PTRx

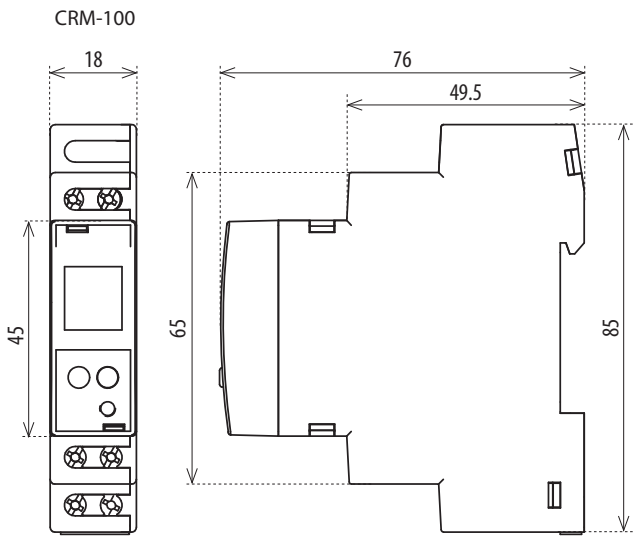
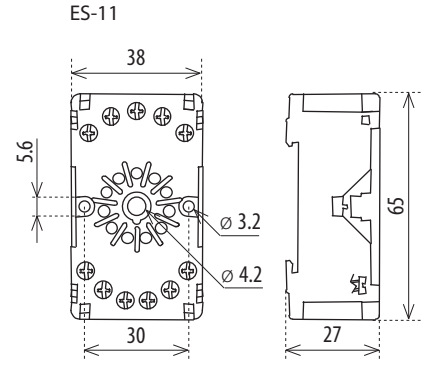

BR-216-10  
BR-216-11  
BR-216-20

BR-220-20  
BR-232-20

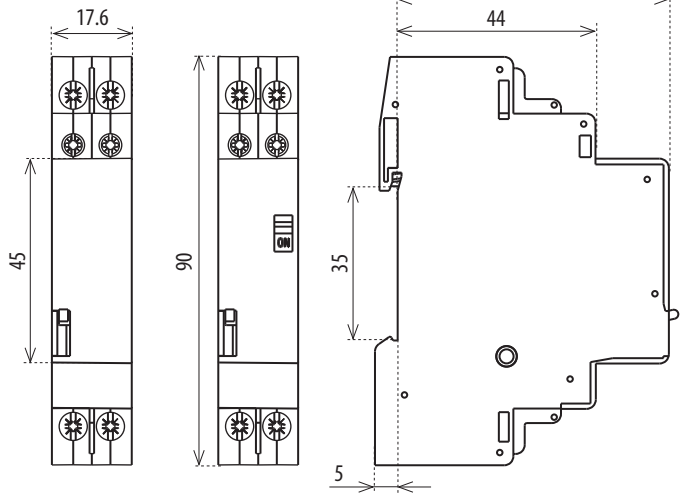

PS1M-15/12V  
PS1M-15/24V

PS2M-24/12V  
PS2M-30/24V

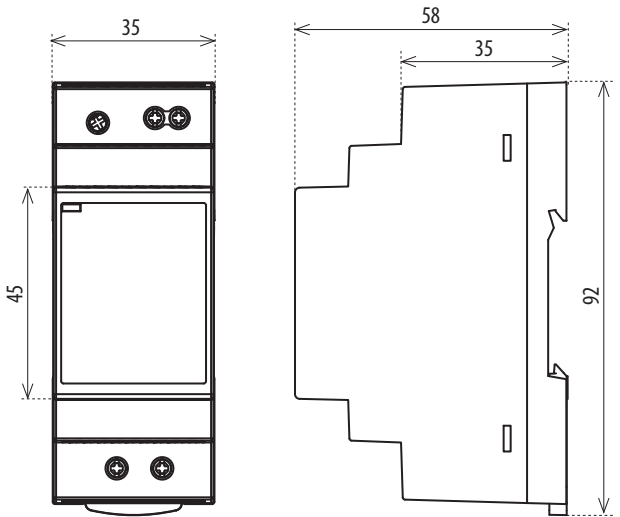
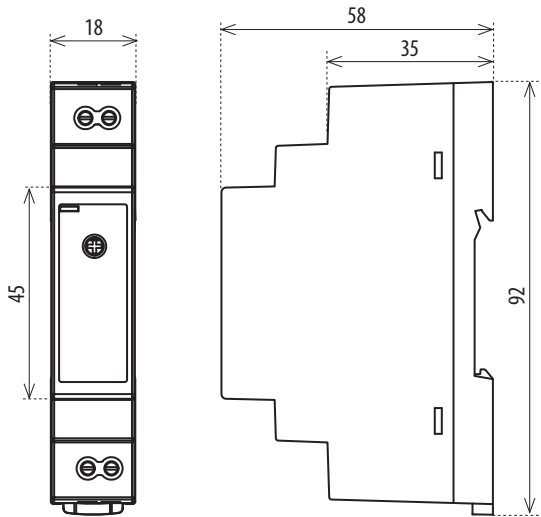

VS120  
VS220  
VSM220

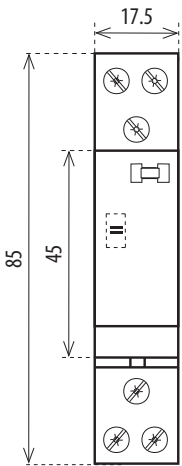

VS425  
VSM425

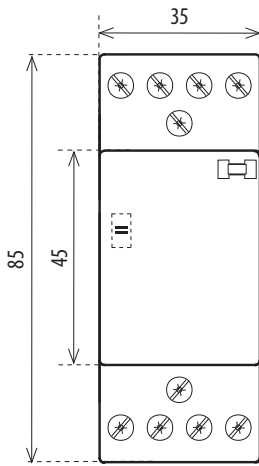

VS440  
VS463

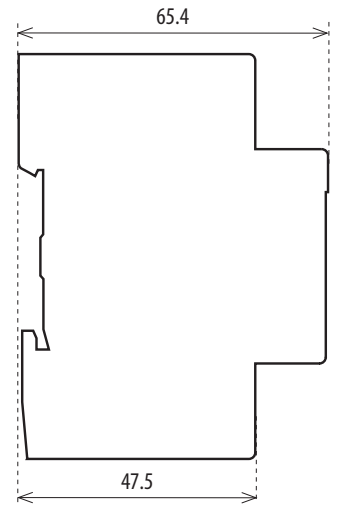
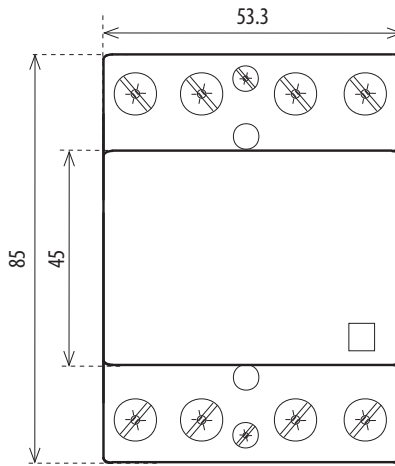

VS420

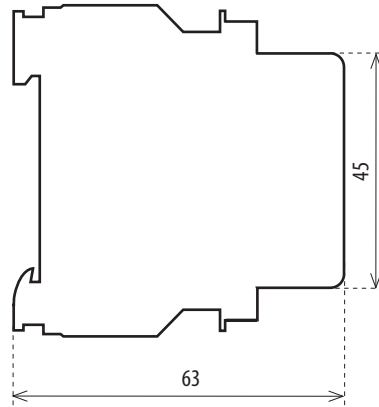
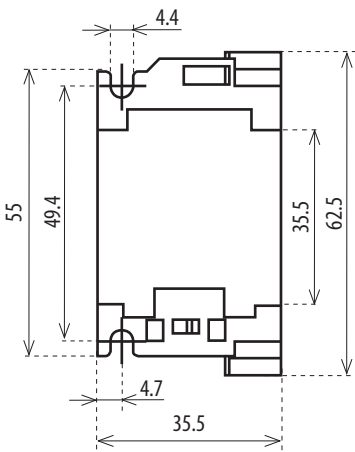

VSK-11  
VSK-20

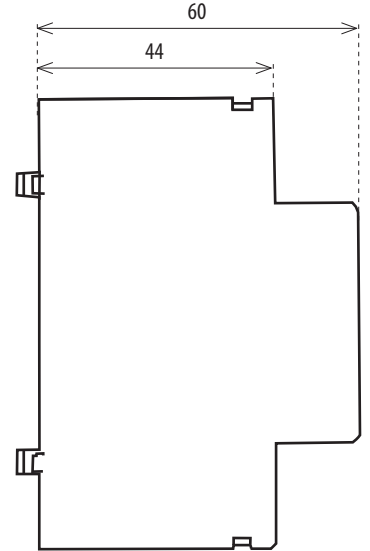
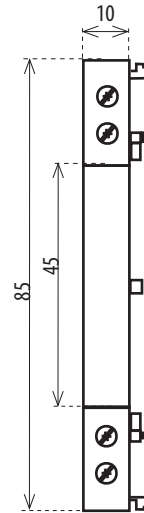

PS3M-54/12V  
PS3M-60/24V

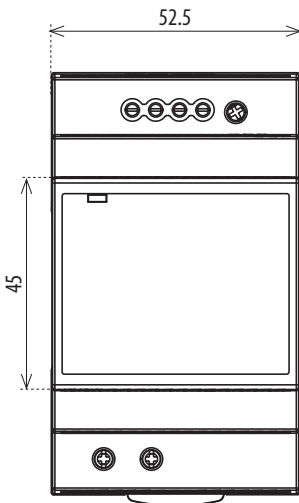

PS4M-85/12V  
PS4M-92/24V

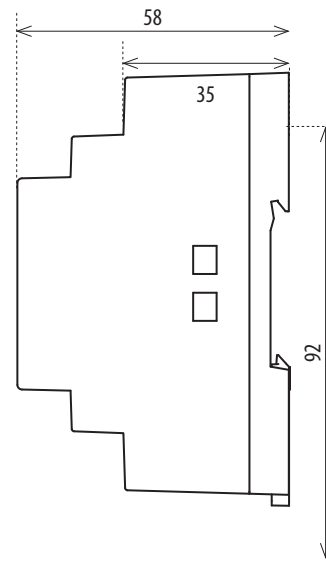
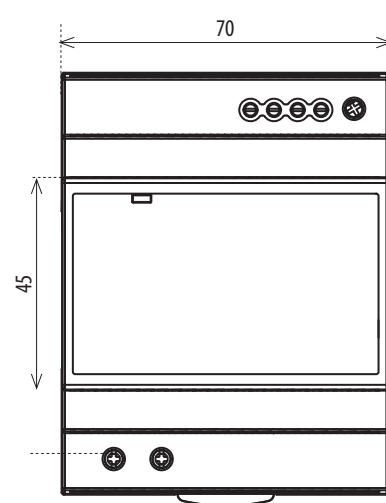

Comb busbar CB-17-8

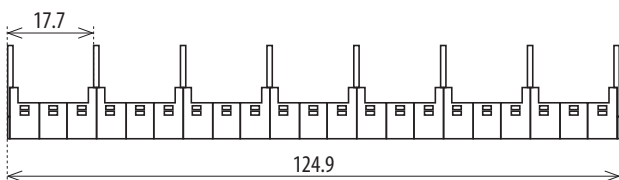

Multifunction time relay CRM-91H, CRM-93H

- for electric appliances, where is necessary to change the exact timing - controlling of the illumination, heating, motors, machines, ventilators, contactors...

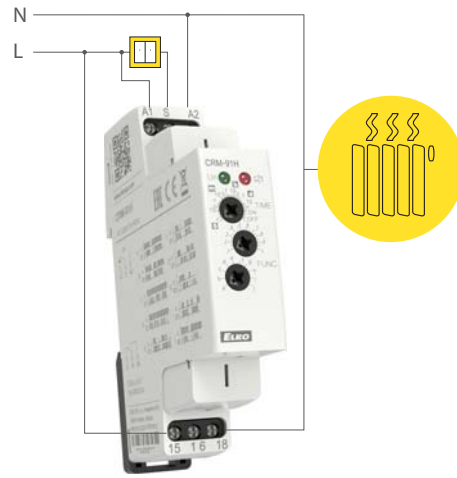

Multifunction time relay with external potentiometer CRM-91HE

- time adjusting via external operating unit, operating on panel, switchboard doors

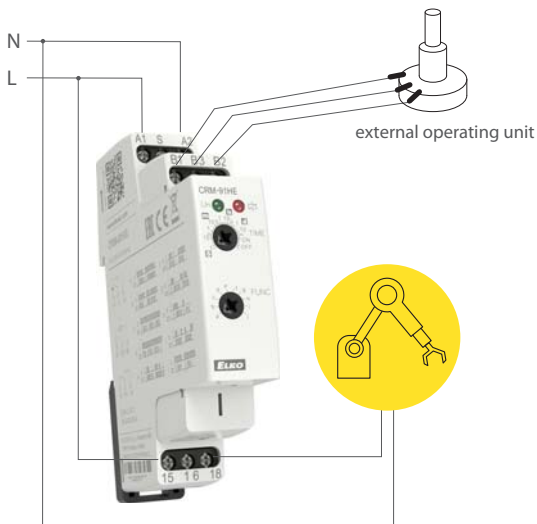

Doublestage delay unit SJR-2

- for sequential load switching, electric furnaces, heaters....

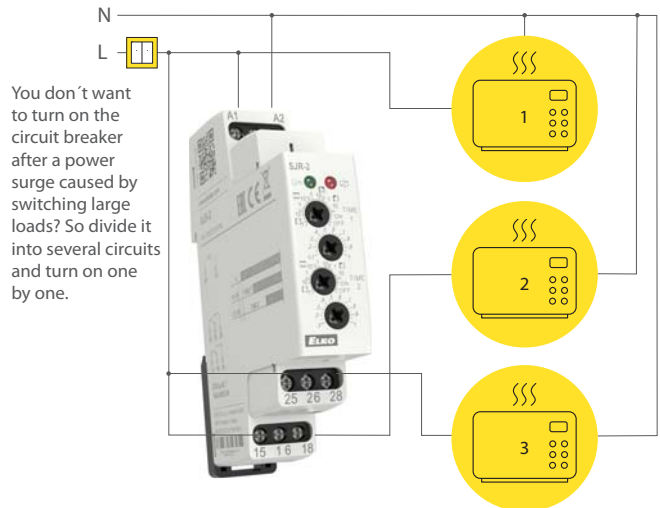

Multifunction time relay CRM-61

- for electronic appliances, light control, heating, motors, fans....

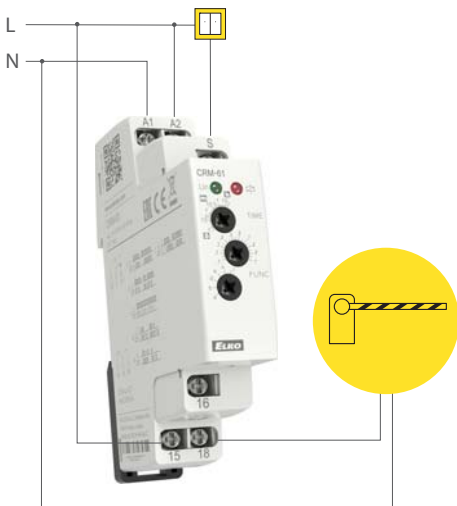

Staircase switch CRM-4

- staircase automatic systems, ventilators switching, for multiplace operating illumination on the staircases and halls...

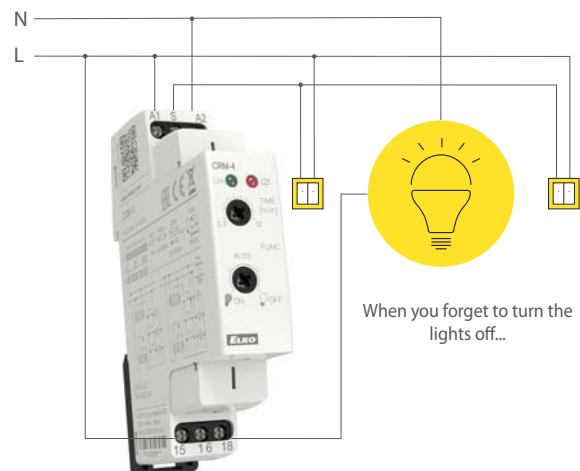

**Time relay PLUG-IN type PTRM-216TP**

- serves to control light signalization, heating, motor and fan control etc.



**Delay OFF without supply voltage CRM-82TO**

- delayed back-up switch off at current failure (emergency illumination, emergency respirator)

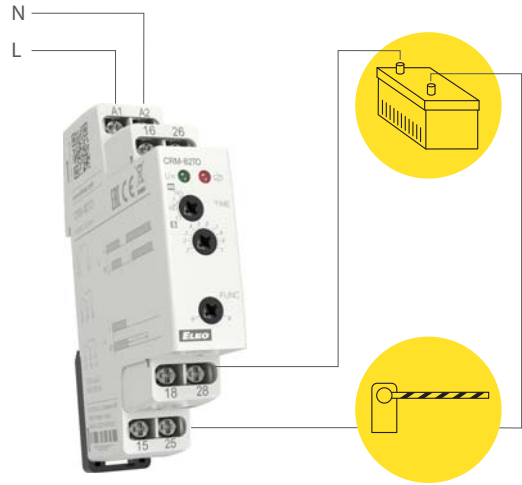

**Asymmetric flasher CRM-2H**

- regular rooms ventilation, cyclic humidity exhaustion, illumination controlling, circulation pump, flash, warning appliances, regular pump down, regular irrigation via electromagnetic valve

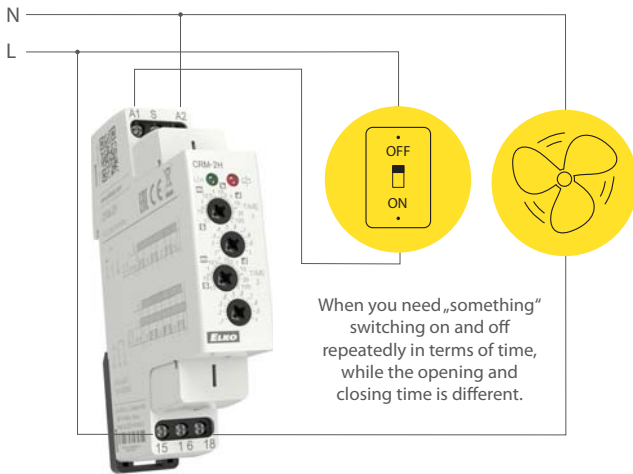

**Singlefunction time relay CRM-81J**

- time switch, using for run down the pump after switch off the heating, switching of ventilators ...

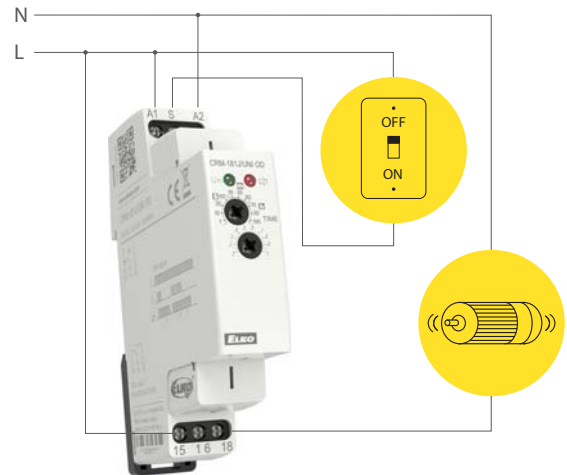

**Intelligent staircase automat with possible signalling before switch off CRM-46**

- staircase illumination operation  
- on-coming switch off signalling (flash = comfort + safety together)

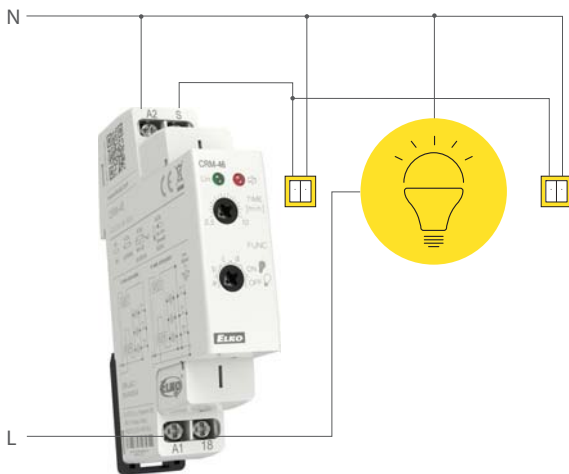

**Room energy saving relay CRM-101**

- replacement of the card switch (energy saving in the absence of guests)  
- The relay controls the hotel room contactor by means of a magnetic door contact and a motion detector

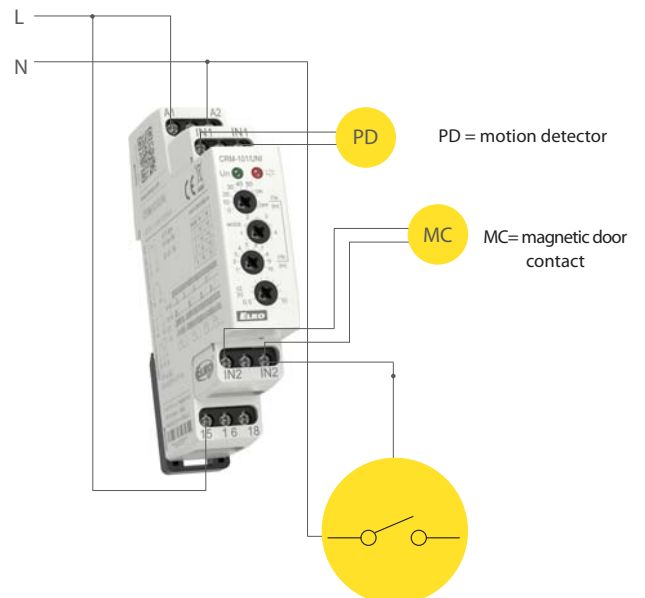

**Digital time switch SHT-1/2**

- for controlling of all appliances that depend on real time, appliances could be controlled in regular cycles, or according to adjusted program (blocking of main door out of working hours or night)
- in combination with other devices, controlling could be combined (rooms ventilation, irrigation controlling, bell at school or in church...)

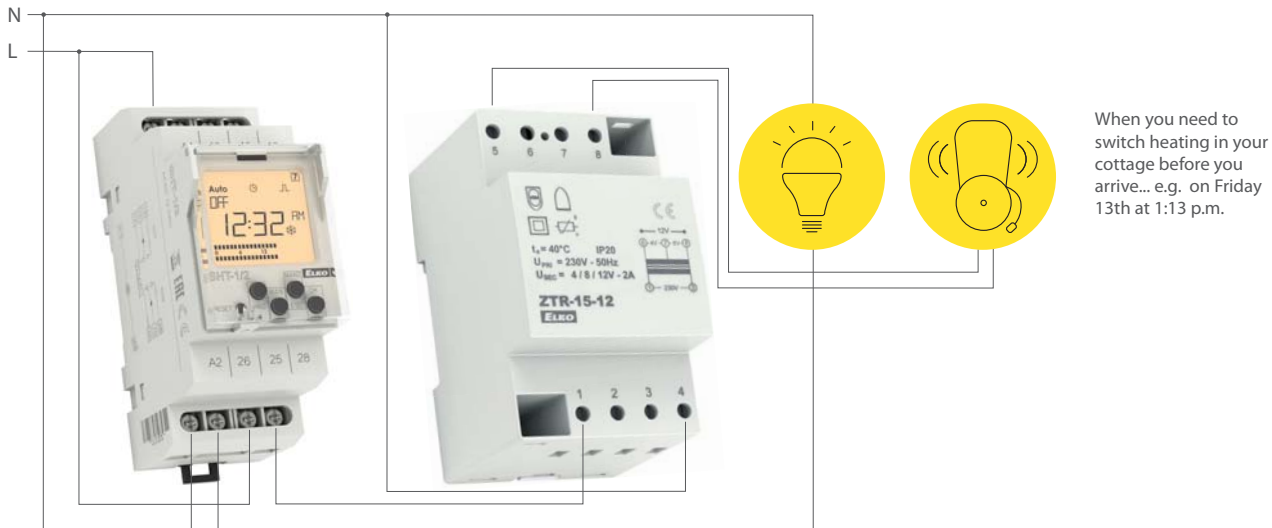

**Programmable digital relay PDR-2**

- illumination, ventilators, contactors controlling, controlling of interlocking plans, system of time abate and blocking (billiards, pin-balls...), away control via external buttons



**Twilight switch SOU-1**

- outdoor illumination switching (garden illumination), flash, shop-window, hall and office illumination (switch off in desired light level, controlling of intensity)

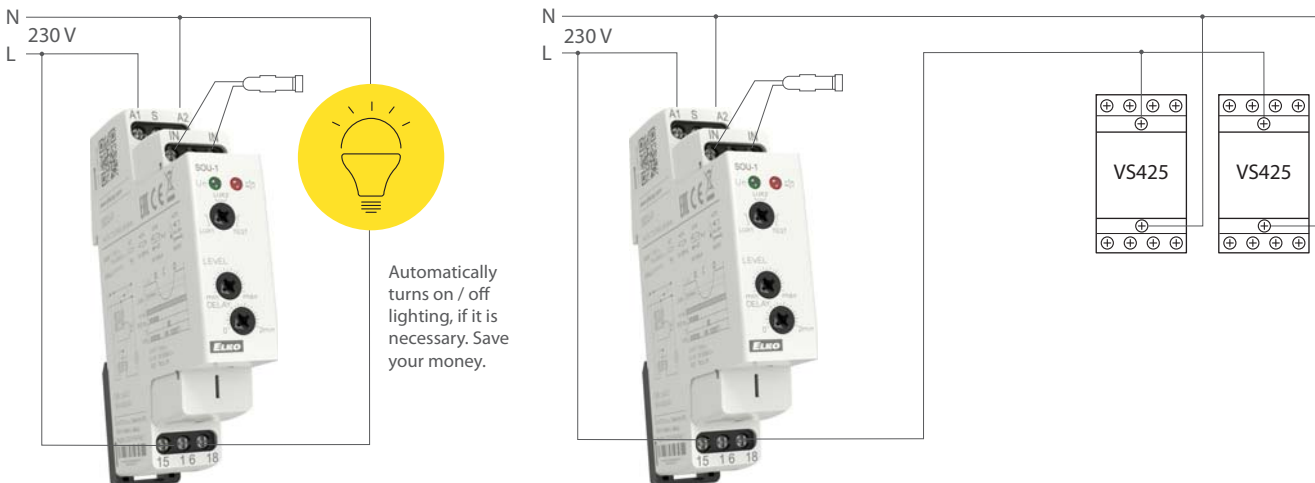



**Delay on star/delta CRM-2T**

- motor starting more than 3 kW, electronic switchover from mode start to mode operation with device CRM-2T, what assures exact timing

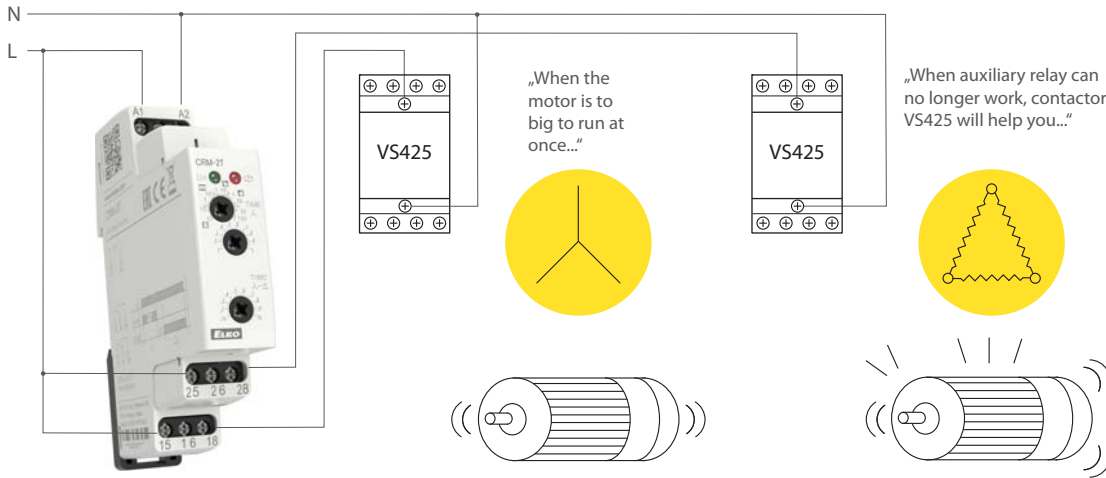

**Mini contactor VS425**

- switching of the higher loads, especially in other categories than AC1

**Modular contactor VS120, VS220, VS420, VS425**

- to switch circuits for supply and control of heating, lights, air-conditioning and other el. devices.  
Switches loads AC-1, AC-3, AC-7a, AC-7b, AC-15.

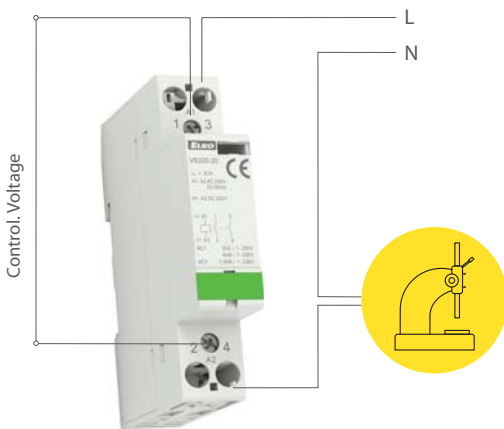

**Modular contactors VS440, VS463**

- to switch supply and control circuits for heating, air-conditioning and other el. devices, switching 3-phase motors  
Switches loads A-1, AC-3, AC-7a, AC-7b, and AC-15

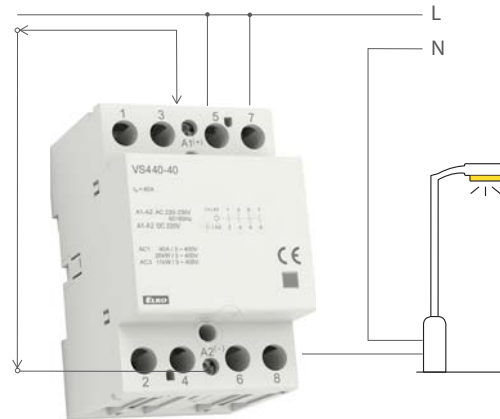

**Digital time switch SHT-1, SHT-1/2**

- for controlling of all appliances that depend on real time, in daily or weekly mode



**Staircase automat with dimming DIM-2**

- step by step (fluent) dim up, adjusted time is ON and fluent dim down (e.g. possible to adjust permanent shine to min. brightness everlasting light)  
- block of flats (entry, halls, staircases), garden lighting

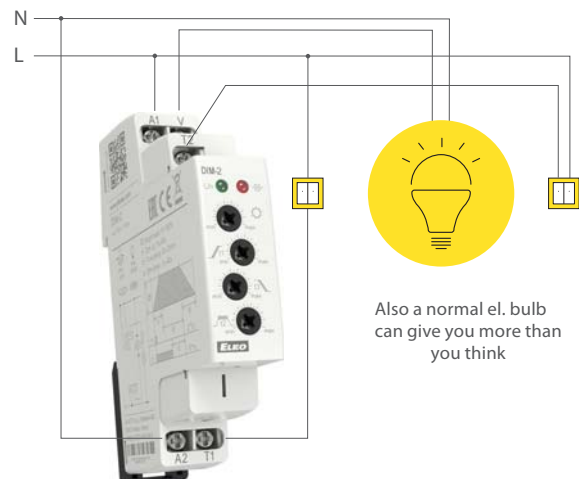

**Monitoring voltage relay HRN-33 (35)**

- monitoring of mains voltage for appliances inclinable to supply tolerance

**Monitoring voltage relay HRN-33 (35)**

- protection of appliances against under-/overvoltage

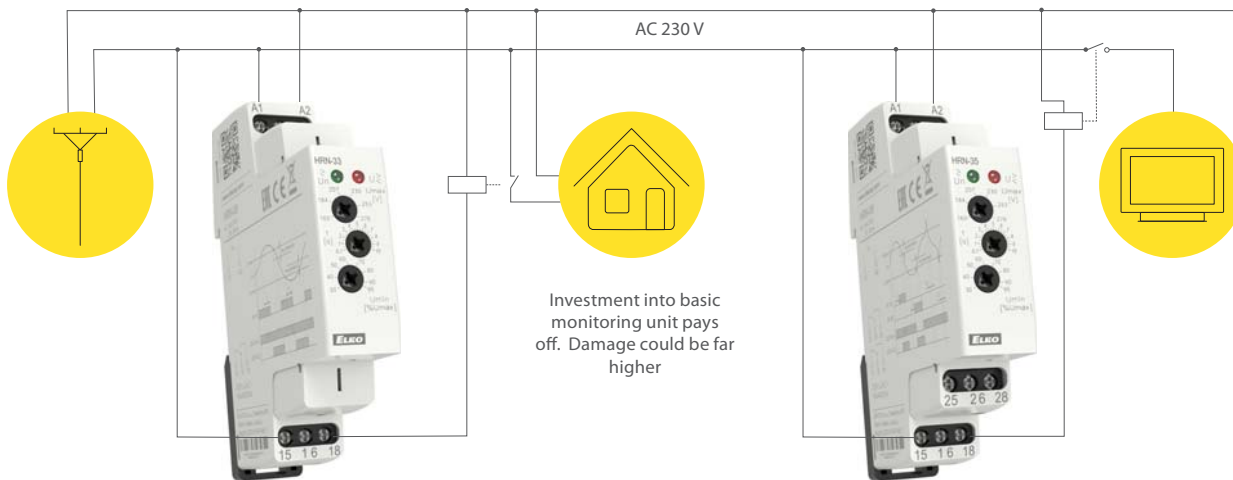

**Switching power supply PS-R**

- power supply of any devices and appliances via safe voltage with full galvanically separated from mains  
 - power supply of driving systems, interlocking plants and use in measurement and control

**Controlling and signalling units USS**

- compact dimensions, elegant design, wide range of use, configuration for request  
 - switching and signalling in switchboard, controlling centre, automation...

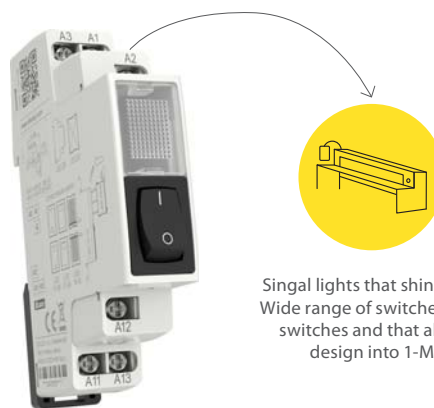
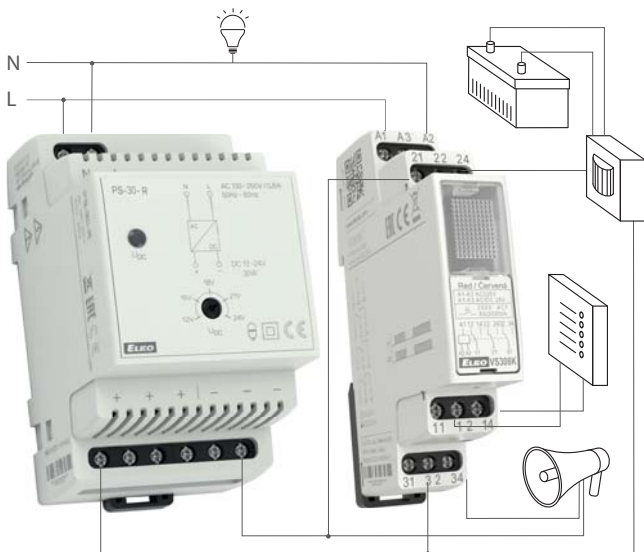

Singal lights that shine and flash:  
 Wide range of switches, alternating switches and that all in double design into 1-MODULE

**Monitoring voltage relay HRN-35**

- start of back-up supply in case of failure

**Monitoring voltage relay HRN-34**

- load disconnected when voltage declines or battery is discharged

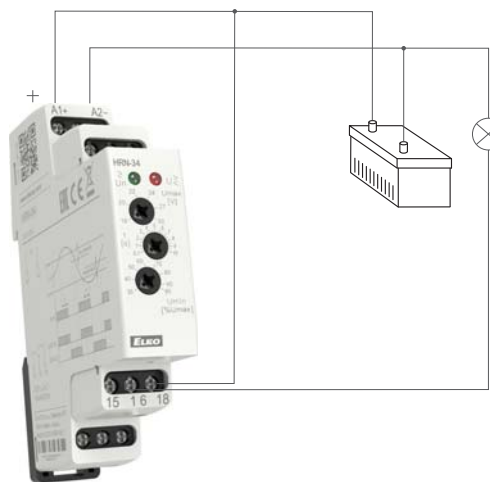
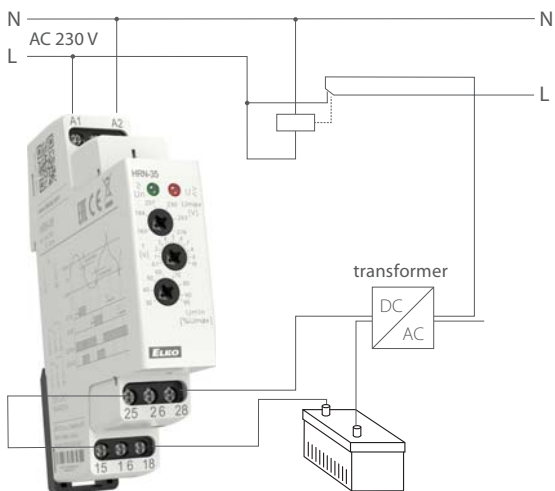

**Memory relay MR-41, MR-42**

- because of 2-wire parallel buttons connection save money, place and time during the installation
- light switching, hall, staircase, big rooms, controlling systems, automation

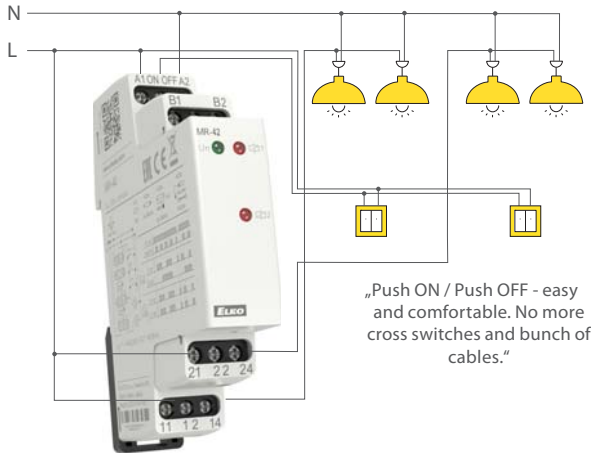

**Power relays VS**

- switching of higher load than is capacity of switched unit = repeater
- assistant light controlling, signalling, boilers, ...



**Monitoring current relay PRI-51, PRI-32**

- current-limiting relay (on one branch two appliances, which never work together), controlling systems, motors, heating, current indication, controlling of 1-phase motor run down, during the installation of main housing switchboard could be controlled via eye, if the cooker is not switched
- in connection with current transformers, it is possible to extend current ranges up to 600A, which makes more things possible

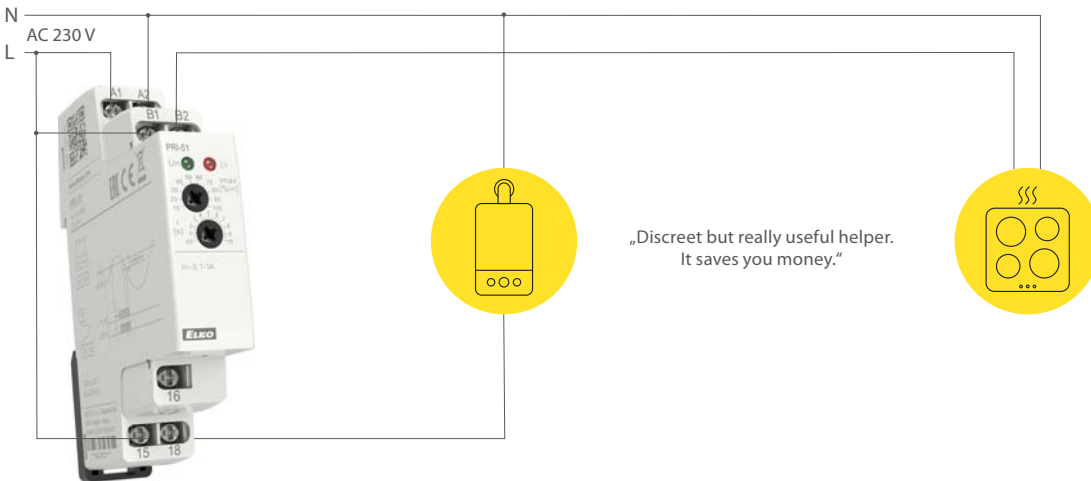

**Relay monitoring power factor COS-2**

- monitors power-factor in 3-phase mains / unloading of motors, pumps, lift systems

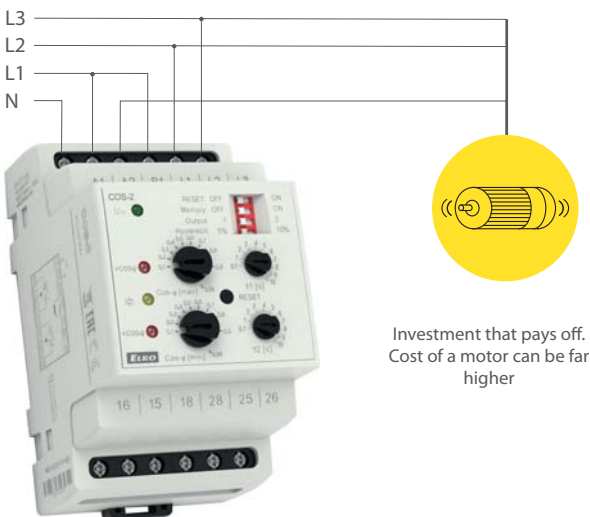

**Monitoring voltage relay HRN-43**

- regulation of voltage from generator, water el. plants, 3-phase control in the main
- monitors and protects main's quality

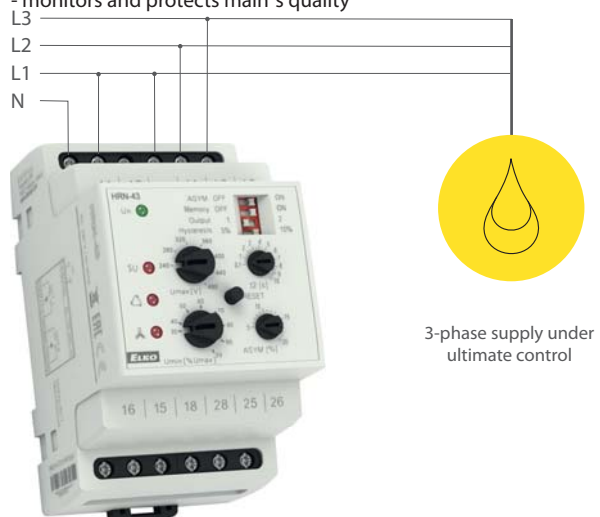

**Level switch HRH-8**

- monitoring level in wells, tanks, pools, etc.

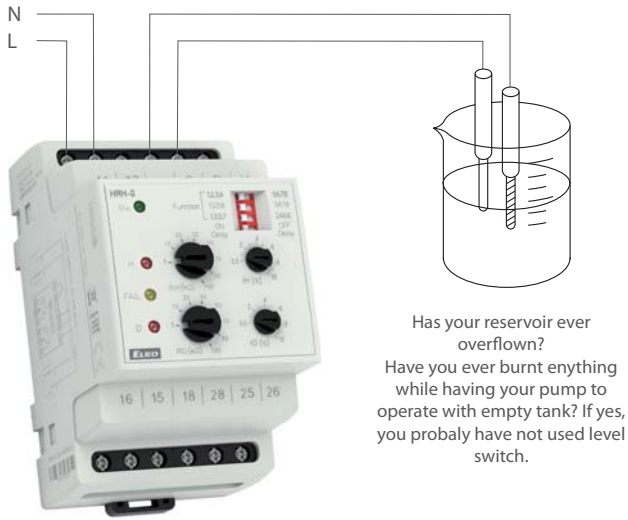

**Level switch HRH-5**

- monitoring level in well, sump, tanks, silo...

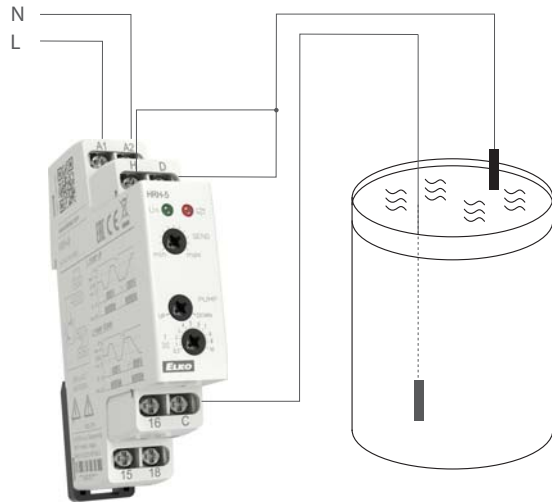

**Thermostat TER-3 with external sensor**

- control of temperature of floor heating

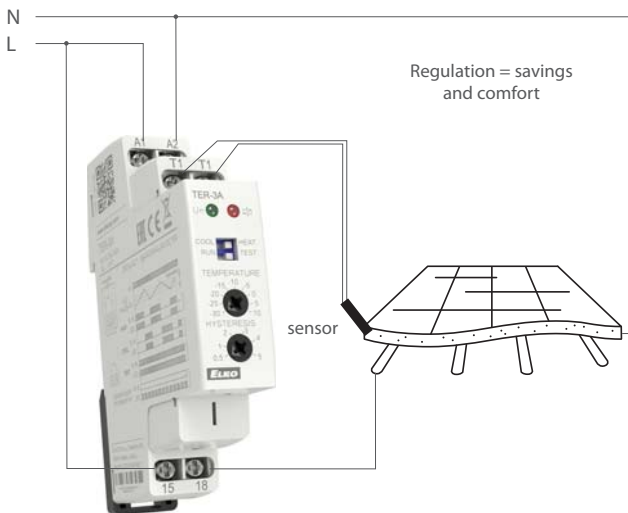

**2 stage thermostat TER-4 with 2 external sensors**

- control of temperature of e.g. gas/electric boiler

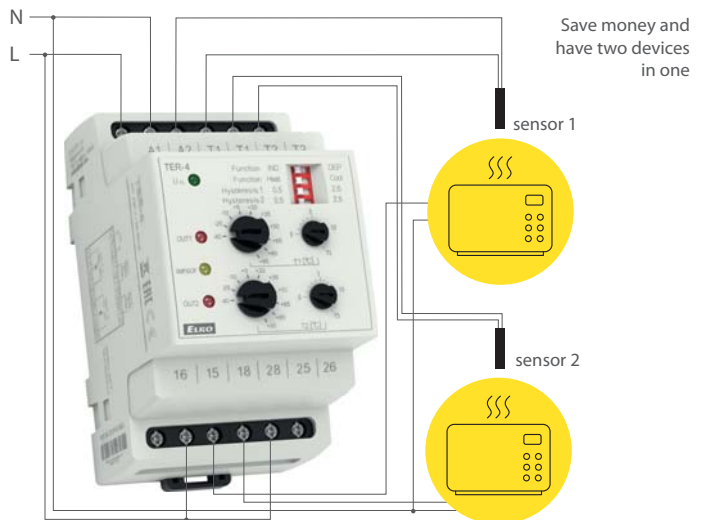

**Thermostat for thermal protection of motors TER-7**

- protection of motors against thermal overload

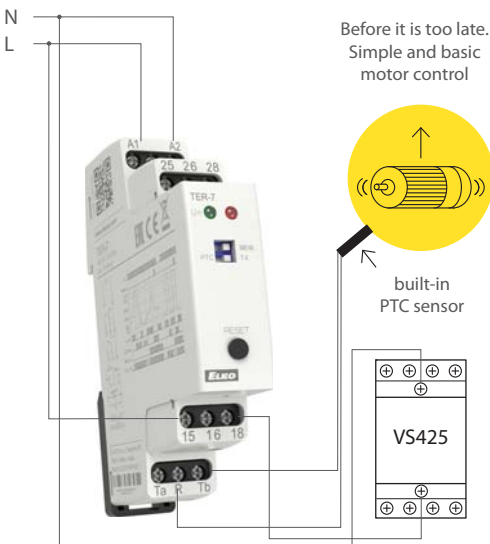

**Multifunction digital thermostat TER-9**

- complex control of heating and water heating in a house

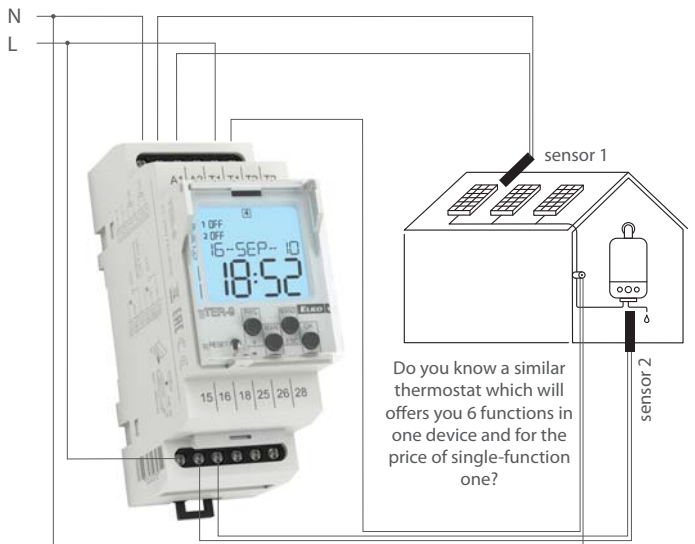

Relay monitoring sequence and failure of phases HRN-55, HRN-55N  
 - monitoring of proper motor rotation, electric drive, etc.

Has your motor ever burnt out?  
 And you didn't know why?  
 Our relay will tell you.

Relay monitoring over-/undervoltage in 3-phase mains HRN-54N  
 - monitoring voltage in switchboard, protection of appliances

Easy and compact solution for monitoring „sensitive“ devices in 3-phase mains. Prevent problems.

Monitoring voltage relay for under/vervoltage for 3-phase mains HRN-54  
 - comfortable monitoring of 3-phase mains

Monitoring current relay PRI-41 (PRI-42)  
 - monitoring over-/underload (machine, motor ...)  
 - monitoring consumption, diagnostics of distant appliance (short circuit, increased consump. ...)

One-phase current under magnifying glass

# Others just resell

HOWEVER, WE DEVELOP AND MANUFACTURE PRODUCTS OURSELVES!



**27 years**  
on the market



**16 years**  
ISO certification



**40**  
developers



**330**  
employees



**2 000 m<sup>2</sup>**  
manufacturing  
space

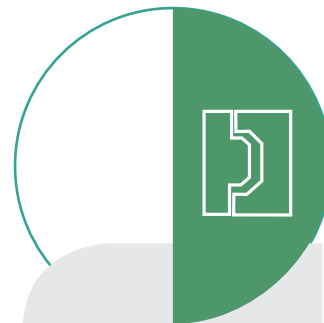

**200**  
proprietary plastic  
mods

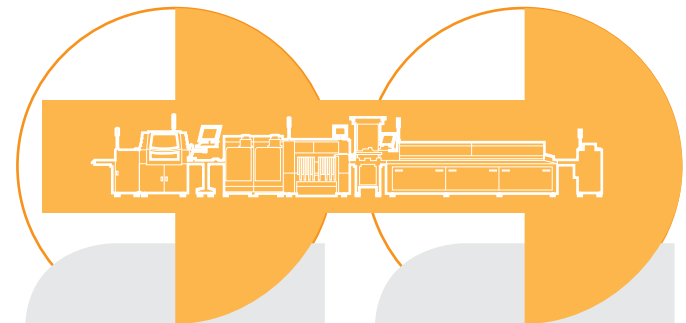

**2**  
SMD lines

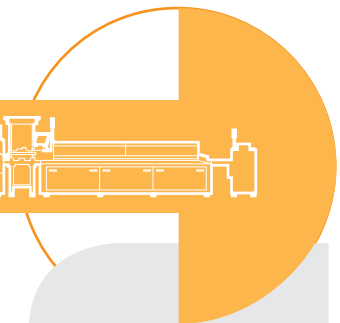

**1 mil.**  
components  
per day

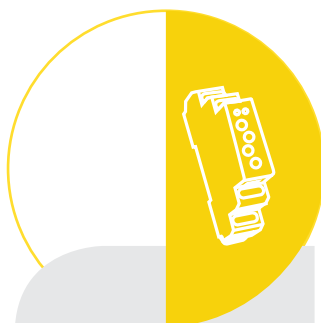

**600 000**  
products  
per year

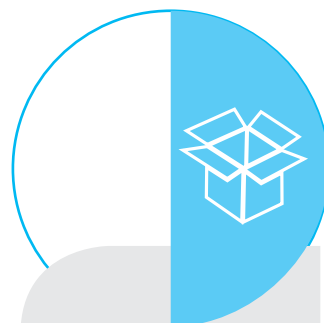

**2 000 m<sup>2</sup>**  
finalization  
and dispatch



**2000**  
warehousing  
spaces



**2**  
printing lasers

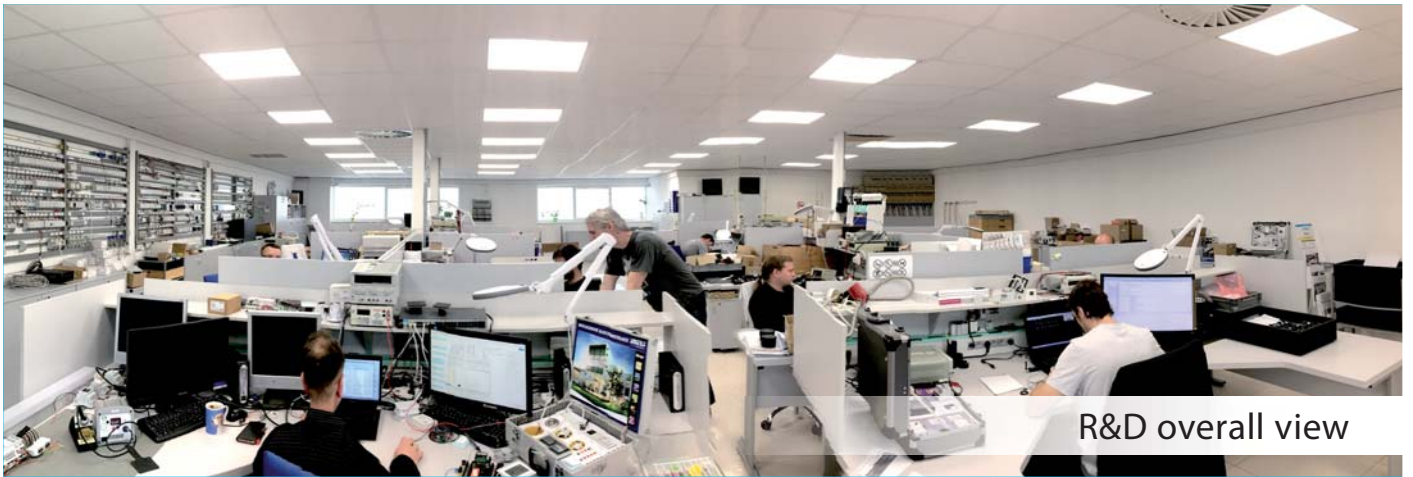

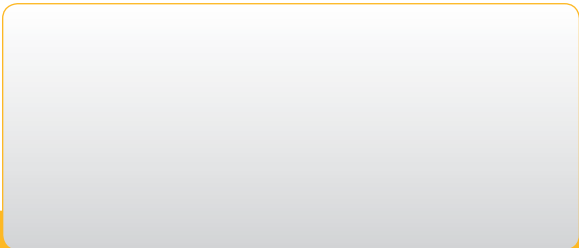
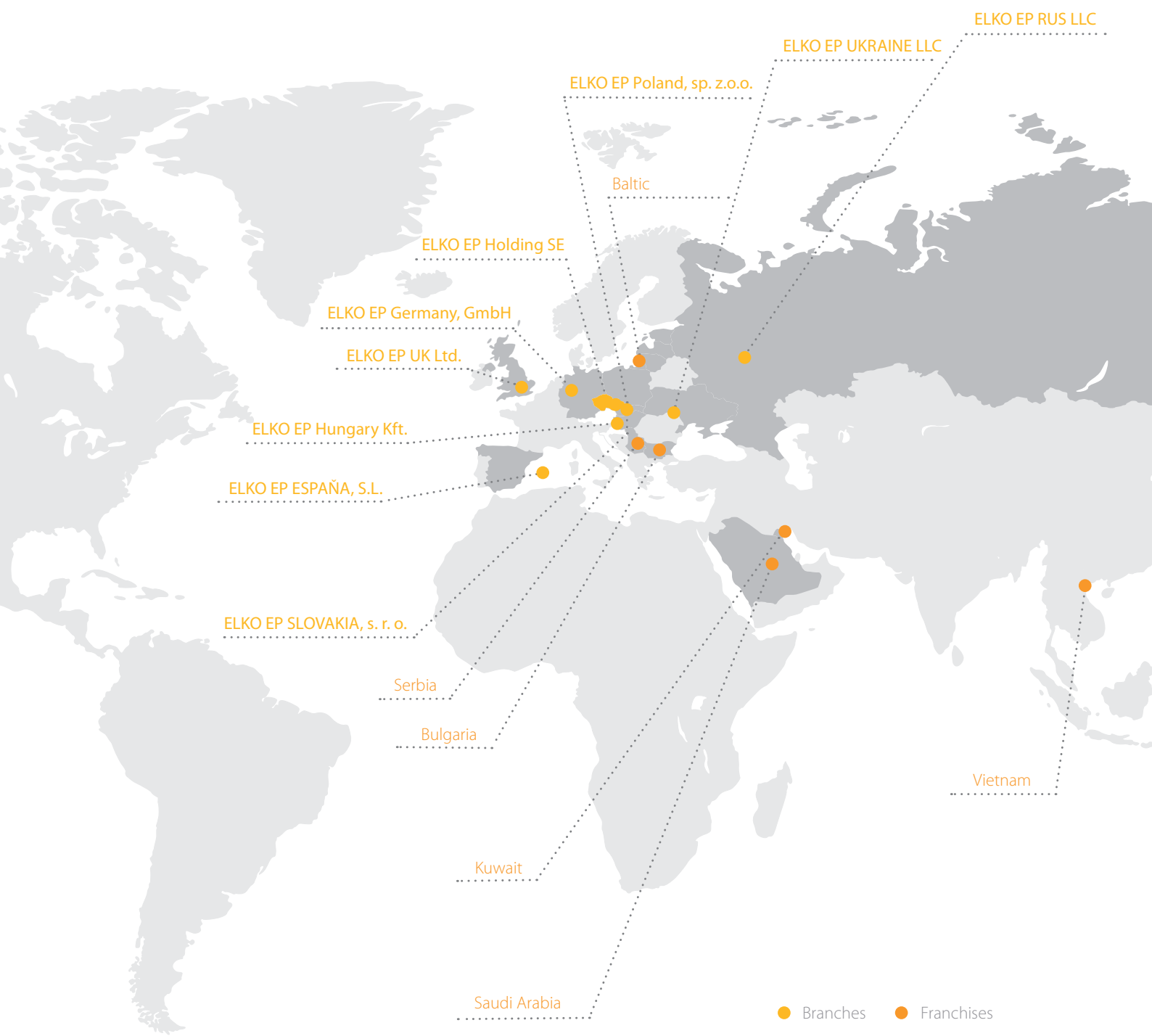

**ELKO EP, s.r.o.** | Palackeho 493 | 769 01 Holesov, Vsetuly | Czech Republic  
 phone: +420 573 514 221 | fax: +420 573 514 227 | elko@elkoep.com | www.elkoep.com

Published: 02/2021 | Modifications or amendments reserved | © Copyright ELKO EP, s.r.o. | 1<sup>st</sup> edition