

# Energy measurement and visualization for existing and new buildings



# Energy management



## Wired solution (iNELS BUS) for larger buildings

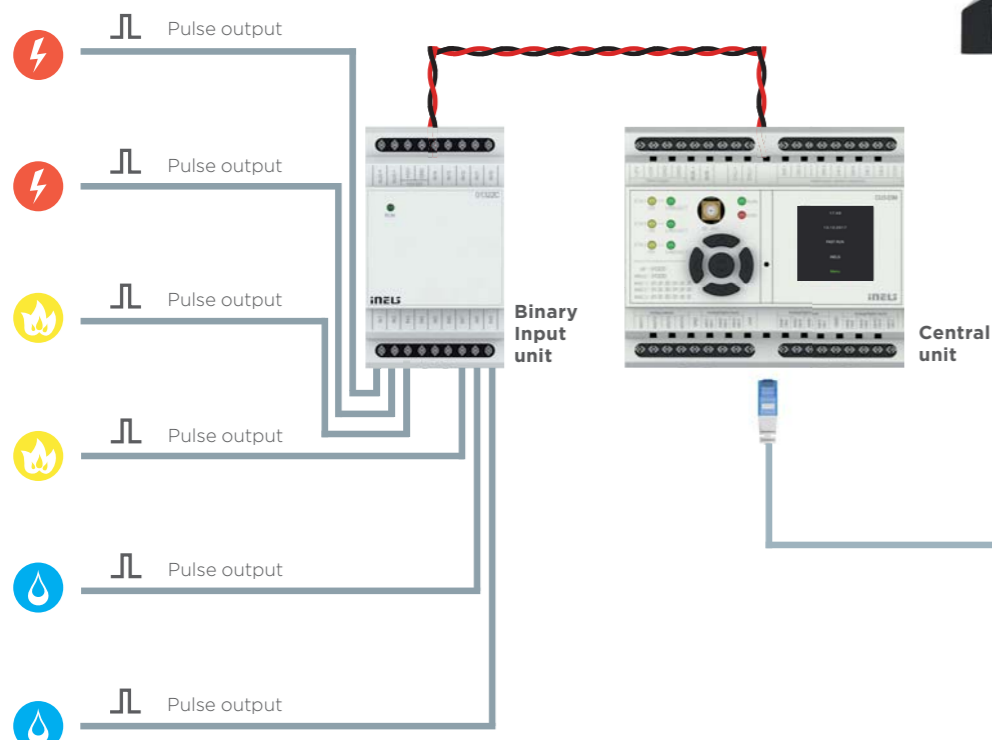

... up to 14 outputs (more IM3-140M input moduls should be used)

## Wireless solution (iNELS RF Control) for existing apartments and houses

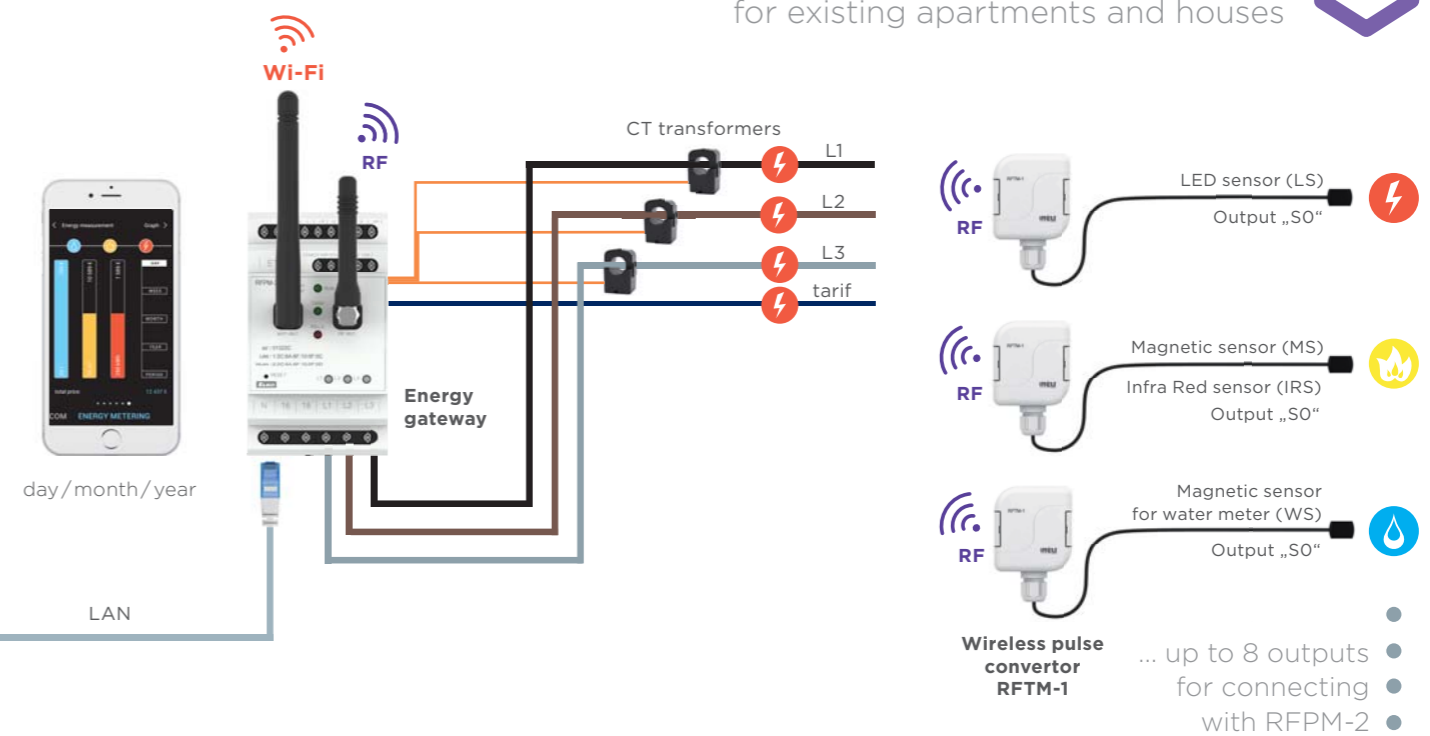

## Wireless solution (iNELS Air - Platforma for IoT) for existing apartments and houses

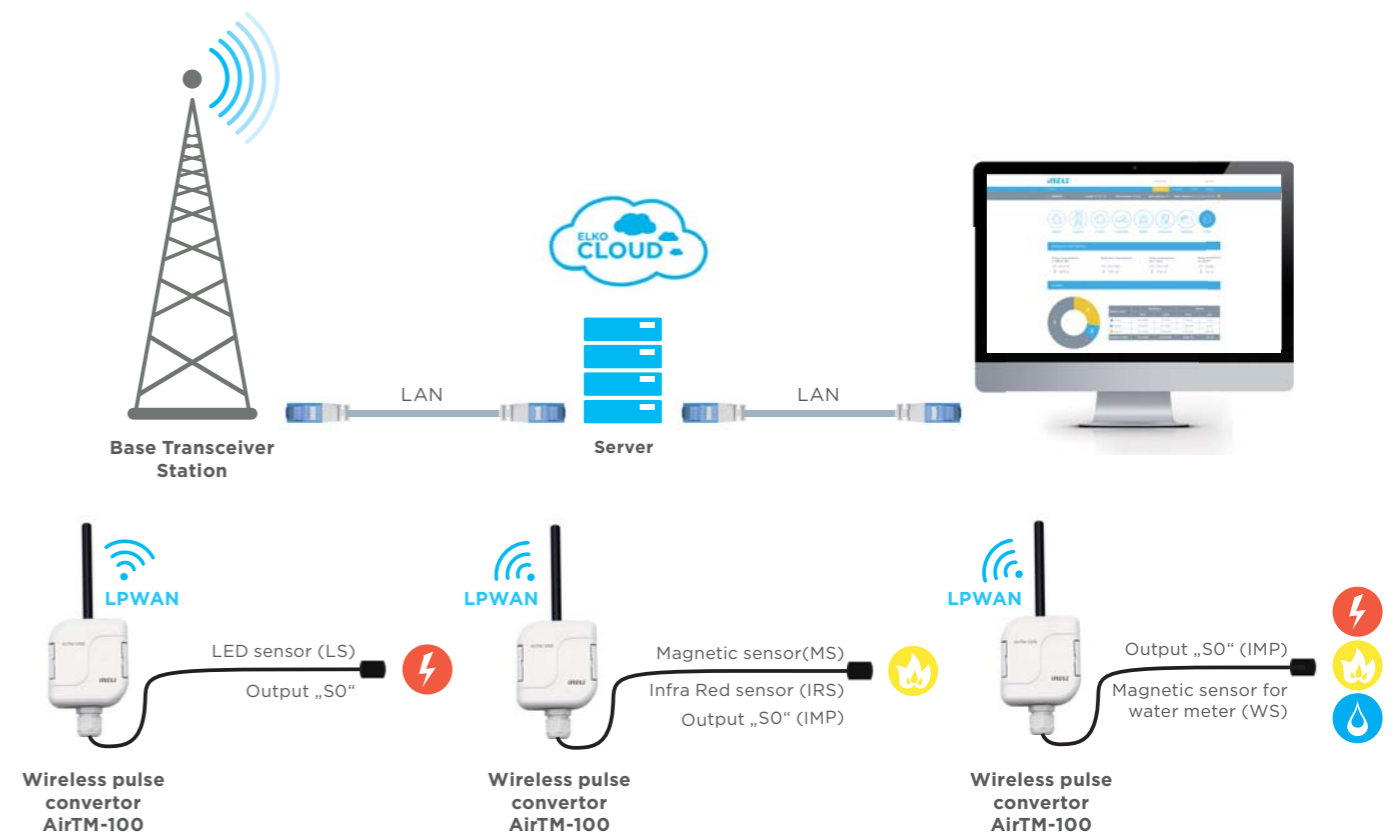



# Wired solution

## iNELS BUS

The BUS solution is used for large buildings, commercial space and apartment buildings with a large number of meters (up to 140). These meters must be equipped with a pulse output, which is connected by wire to the input unit (14 inputs). The input units are connected by bus to the central unit. The central unit is connected by LAN to an Connection Server, which converts measured data to consumption values and consequently then provides such data for display in applications (telephone, tablet, PC, TV).

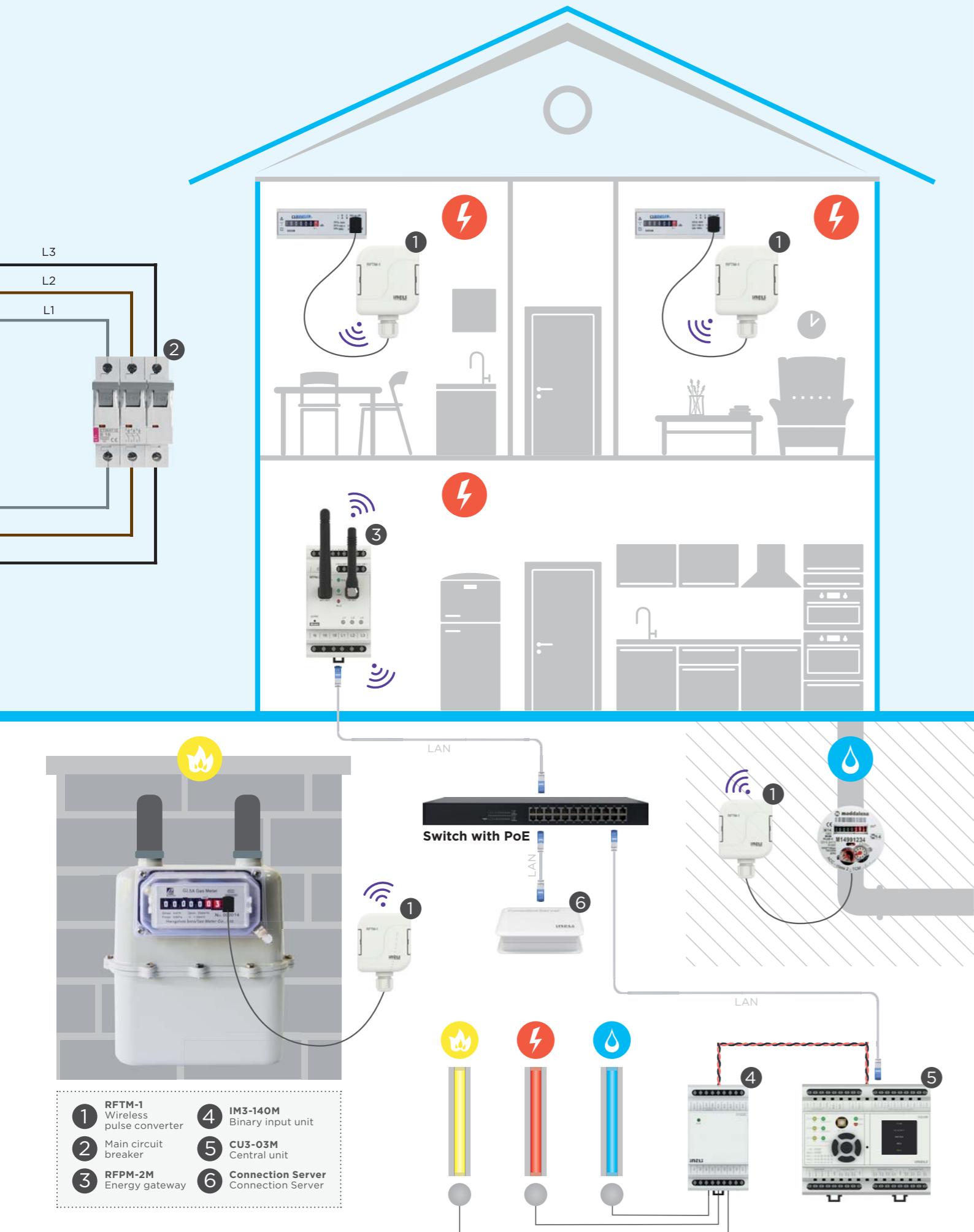

Binary inputs unit

IM3-140M

- IM3-140M is designed to connect up to 14 devices with potentialless contact
- by BUS bus, by which it is also powered, it is connected in the central unit
- there can be up to 10 output units connected, i.e. 140 meters
- it can be combined with further devices with potential free input (buttons, sensors, detectors, etc.) - e.g. a switch for opening the gas meter door...



Central unit

CU3-03M

- the brain of the entire system iNELS and the „interface“ between the user program environment and controllers
- has an OLED display, showing the current status, and enables settings (network settings, date, time, services) central units
- it is possible to connect to it up to two branches of the BUS bus, whereas to each bus, you can connect up to 32 iNELS3 units





# Wireless solution iNELS RF Control

The wireless solution is appropriate for existing buildings where metering equipment has already been installed. It is therefore necessary to sense the measured values (without interfering in metering equipment) and transfer data to the energy gateway, which processes the data and renders it for assessment. Methods of sensing meters function on the principle of sensing pulses, flashing of an LED, turning of a dial or a unit wheel. By means of a converter, these pulses are transmitted wirelessly to the energy gateway, which provides them with information for visualization in the application in a smartphone, tablet or stores them on the ELKO Cloud.

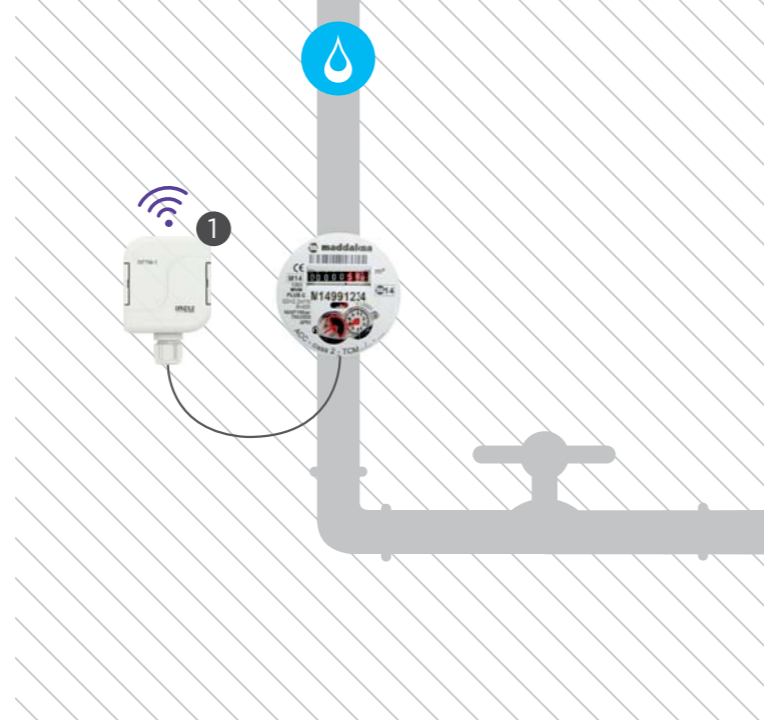
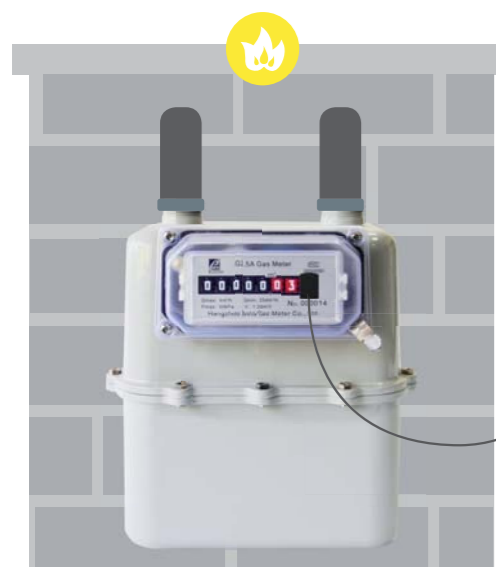
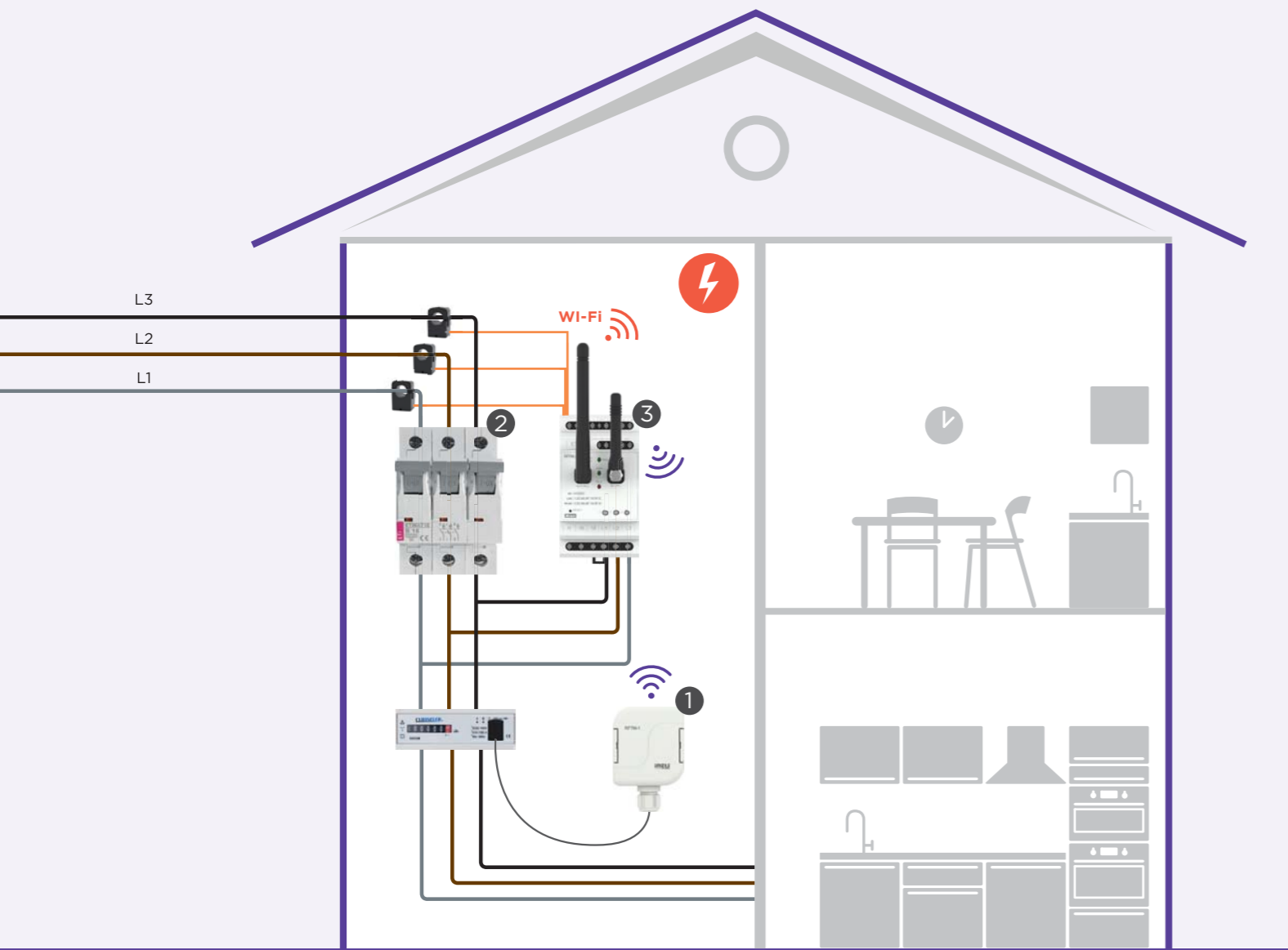

- 1 RFTM-1 Wireless pulse converter
- 2 Main circuit breaker
- 3 RFPM-2M Energy gateway



Energy gateway

RFPM-2M

- energy gateway for data collection from meter sensors and measuring current probes
- interface for displaying on mobile devices and Cloud storage
- 2x inputs for connecting potential free pulse outputs of meters
- 3x inputs for connection current probes (CT50) for indirect electricity measurement
- 2x inputs for potential free contact of the tariff switch (SmartGrid)
- RF antenna for wireless receipt from wireless pulse converters

**OUTPUTS AND COMMUNICATION INTERFACES:**

- RJ45 connector for connecting to LAN
- WI-FI antenna for communicating with Mobile devices
- switching contact 16A with potential L1
- BUS for connecting to central unit



Pulse converter

RFTM-1

- detects home energy meters (electricity, water, gas) using sensors and sends them to the wireless unit RFPM-2M
- the sensor is designed for use on existing meters even without impulse output „SO“
- it senses energy meters by means of LS (LED Sensor), MS (Magnetic Sensor), IRS (Infra Red Sensor) or impulse output
- increased IP protection enables use in outdoor areas
- battery power (1.5V/2x AAA) with average battery life of around 2 years (according to amount of transferred information - pulses)



# Wireless solution

## iNELS Air - Platform for IoT

The Internet of Things (IoT) is the concept of connecting appliances, machines, sensors to an existing internet structure. This structure utilizes a specially designed network for small data transfer and low power consumption over long distances. In our concept, we use the Sigfox, LoRa, and NarrowBand networks.

This solution is suitable for existing buildings where meters are already installed. Compared to a classic wireless solution, the great advantage when using these networks is that they do not need another Internet connection. Measured pulses are transmitted wirelessly from the sensor to the transmitting station (BTS), which further passes information to the Server for processing. The evaluated data is then displayed in the Cloud.

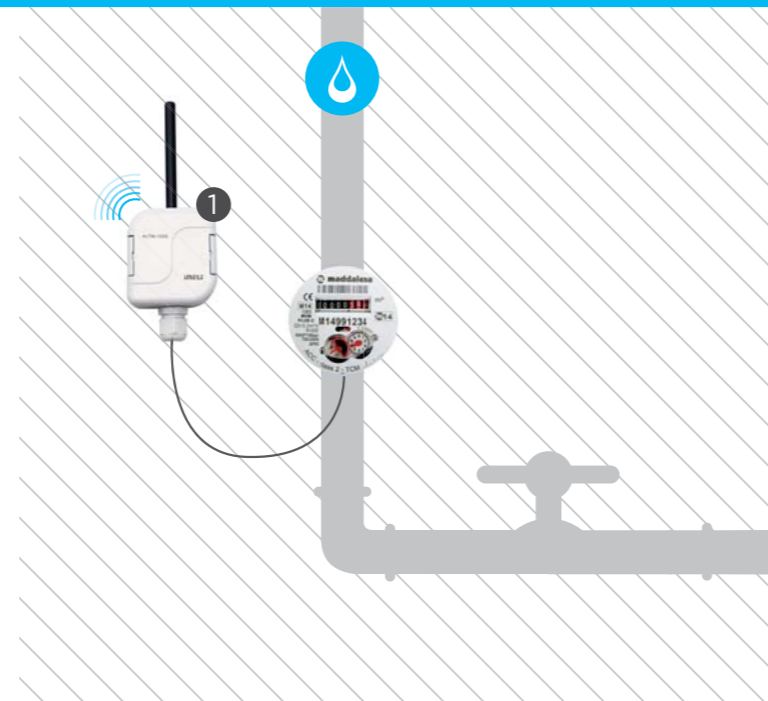
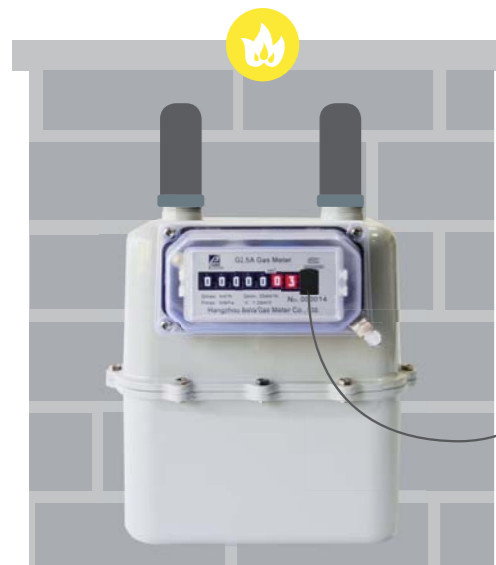
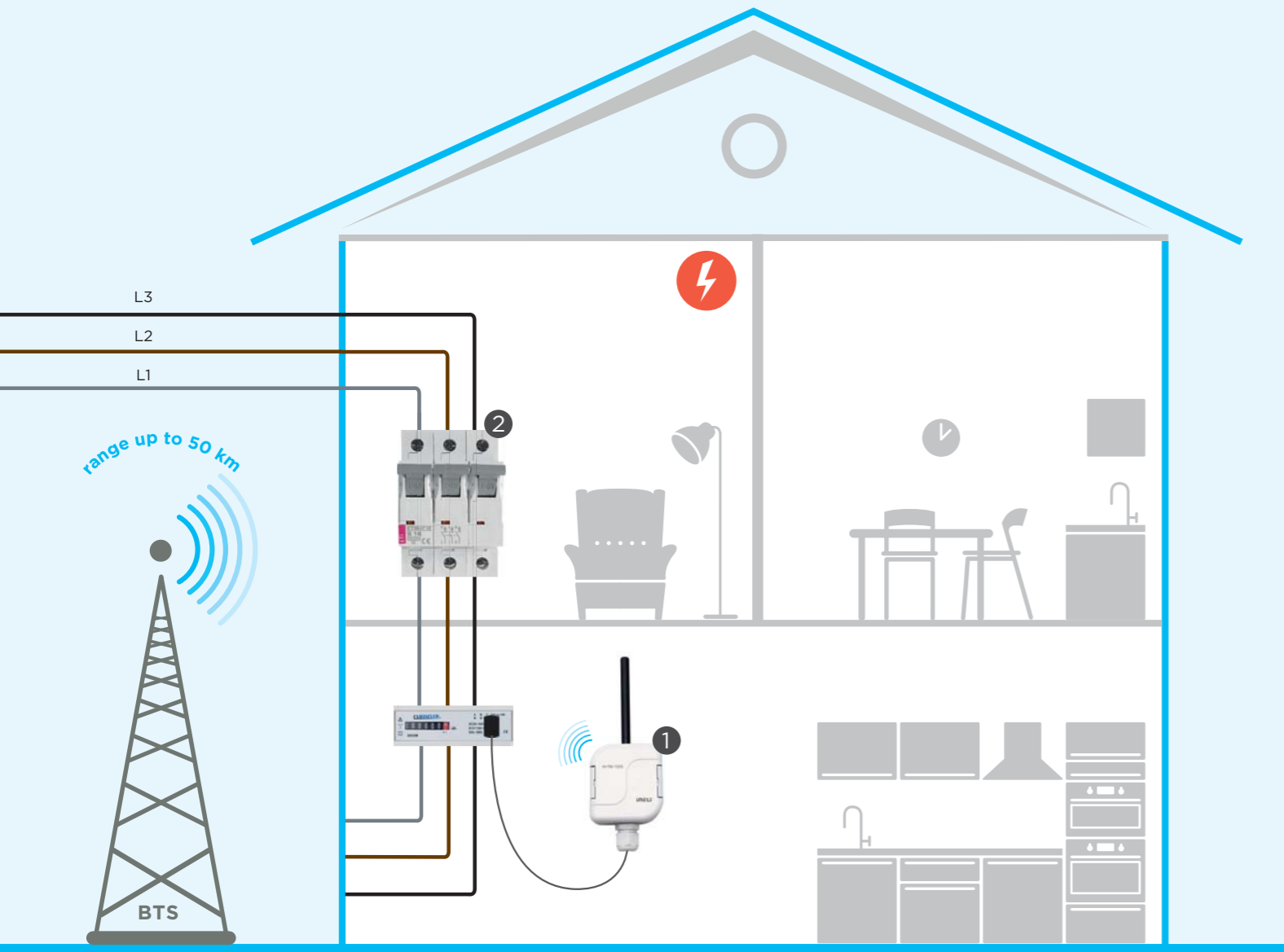

1 AirTM-100 Pulse transmitter 2 Main circuit breaker



### Pulse transmitter

AirTM-100S, AirTM-100L, AirTM-100NB

- a wireless pulse transmitter designed to scan data from home energy meters
- communications are provided by Sigfox, LoRa and Nb-IoT networks
- data are displayed in a smart phone application or ELKO Cloud
- battery power
- in IP65 enclosure (Protection against water, dust, ...)
- supported sensors: LS (LED sensor); MS, WS (magnetic sensor); IRS (IR sensor); SO (contact)



# Methods of sensing meters

## ⚡ CT (Current transformer)

Opening pliers open/close on the existing wire of the measured circuit, most frequently at the main supply at the electricity meter.



## ⚡ LS (LED sensor)

The LED sensor scans LED impulses on the meter, which indicates consumption by flashing.

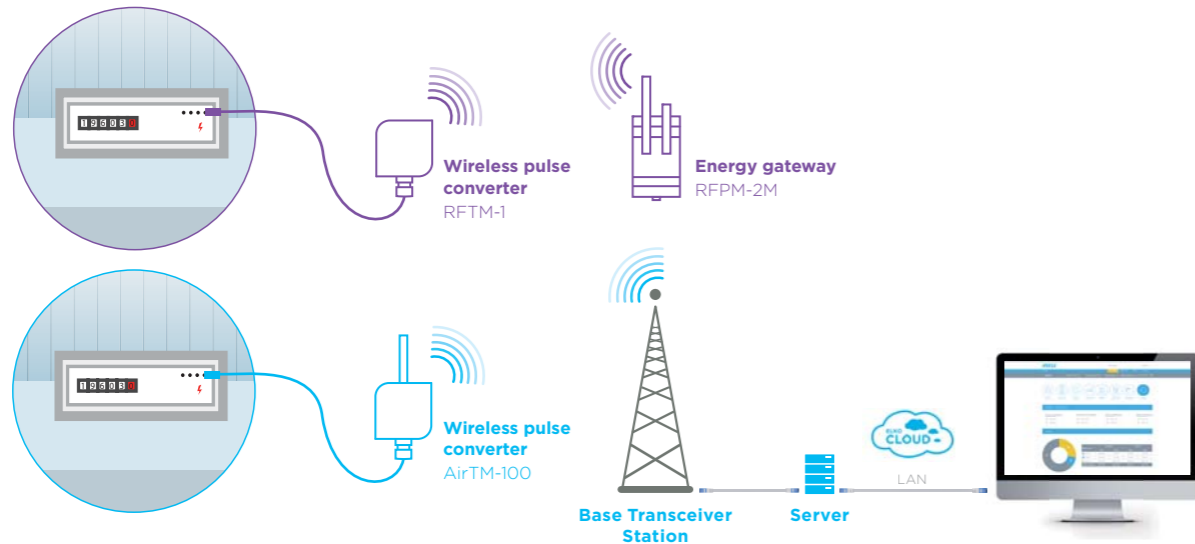

## 🔥 MS (Magnetic sensor)

The magnetic sensor scans movement of the numeral, upon which a permanent magnet is placed.

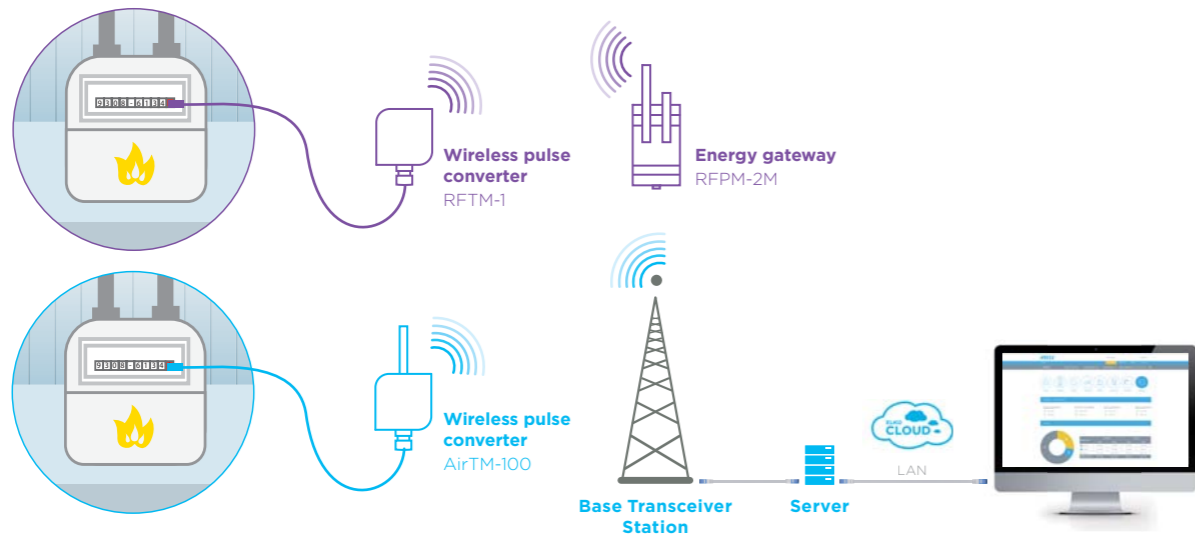

## 🔥 IRS (Infra Red sensor)

The IR sensor senses the reflective curtain placed on the moving number of the meter or senses the rotating indicator (mainly on water meters).

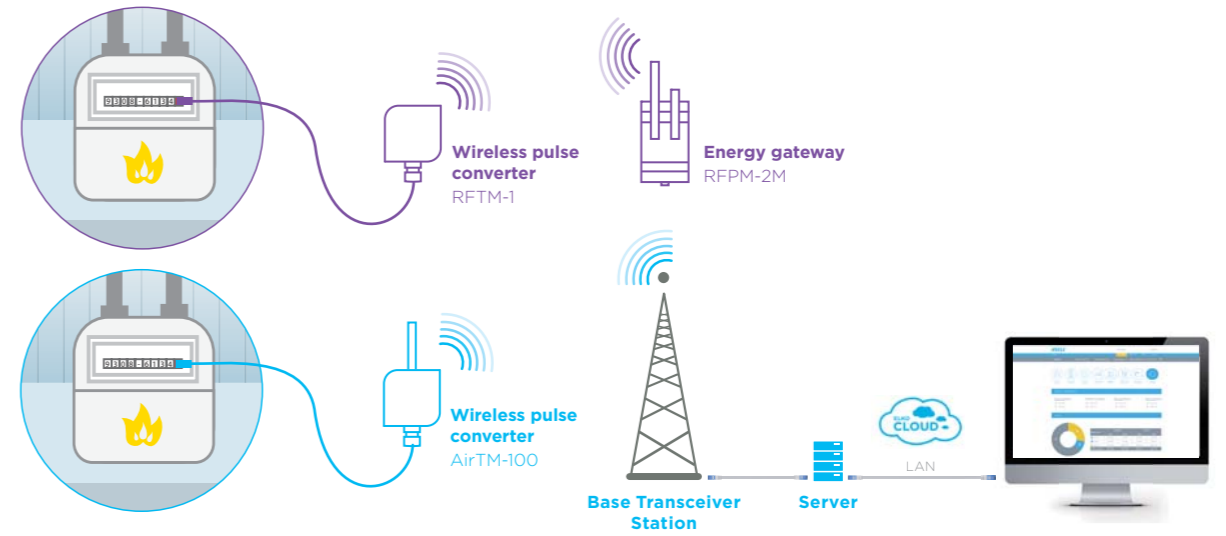

## 💧 WS (Magnetic sensor for water meter)

The magnetic sensor detects the pulse that is created with each rotation of the magnet placed on the unit dial (supported producer Maddalena - type TCM 142/08-4627).

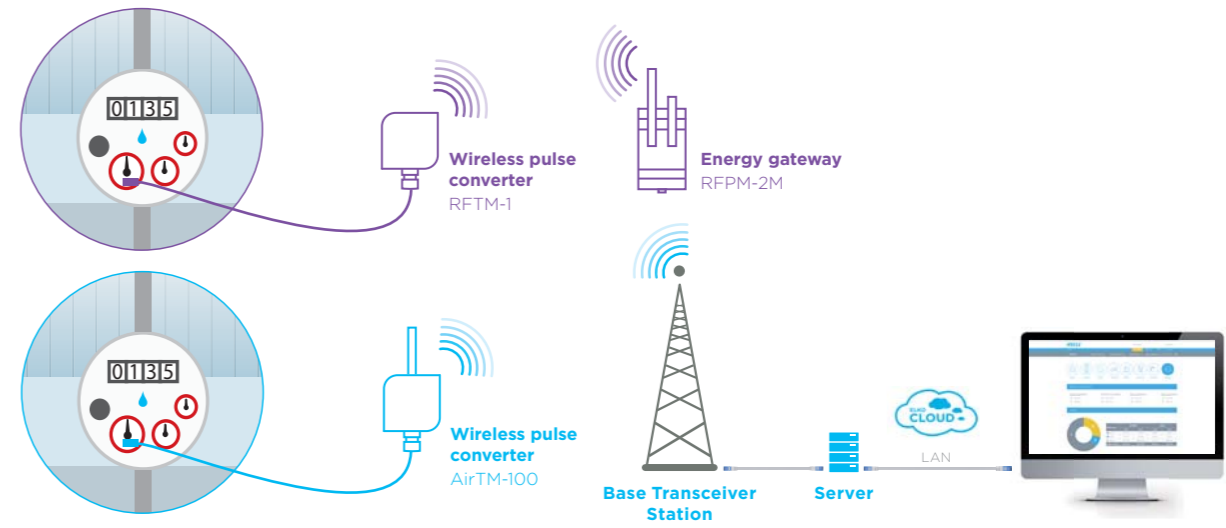

## ⚡🔥💧 IMP (output „SO“)

Meters with impulse output indicated as „SO“ connected by wires to terminals GND and DATA1 on the sensor AirTM-100.

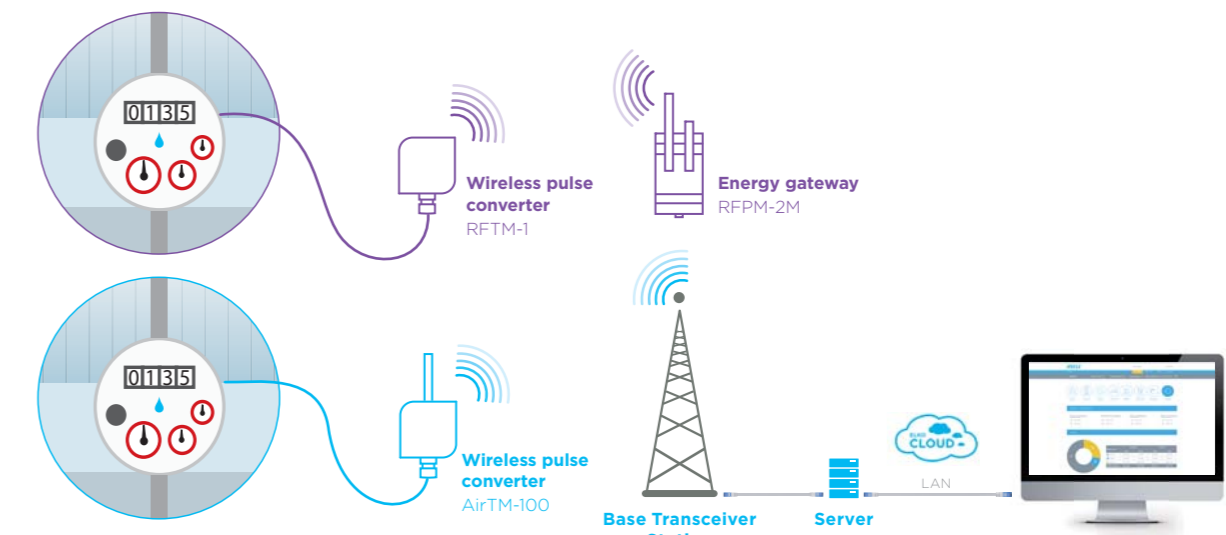

# ELKO EP Holding

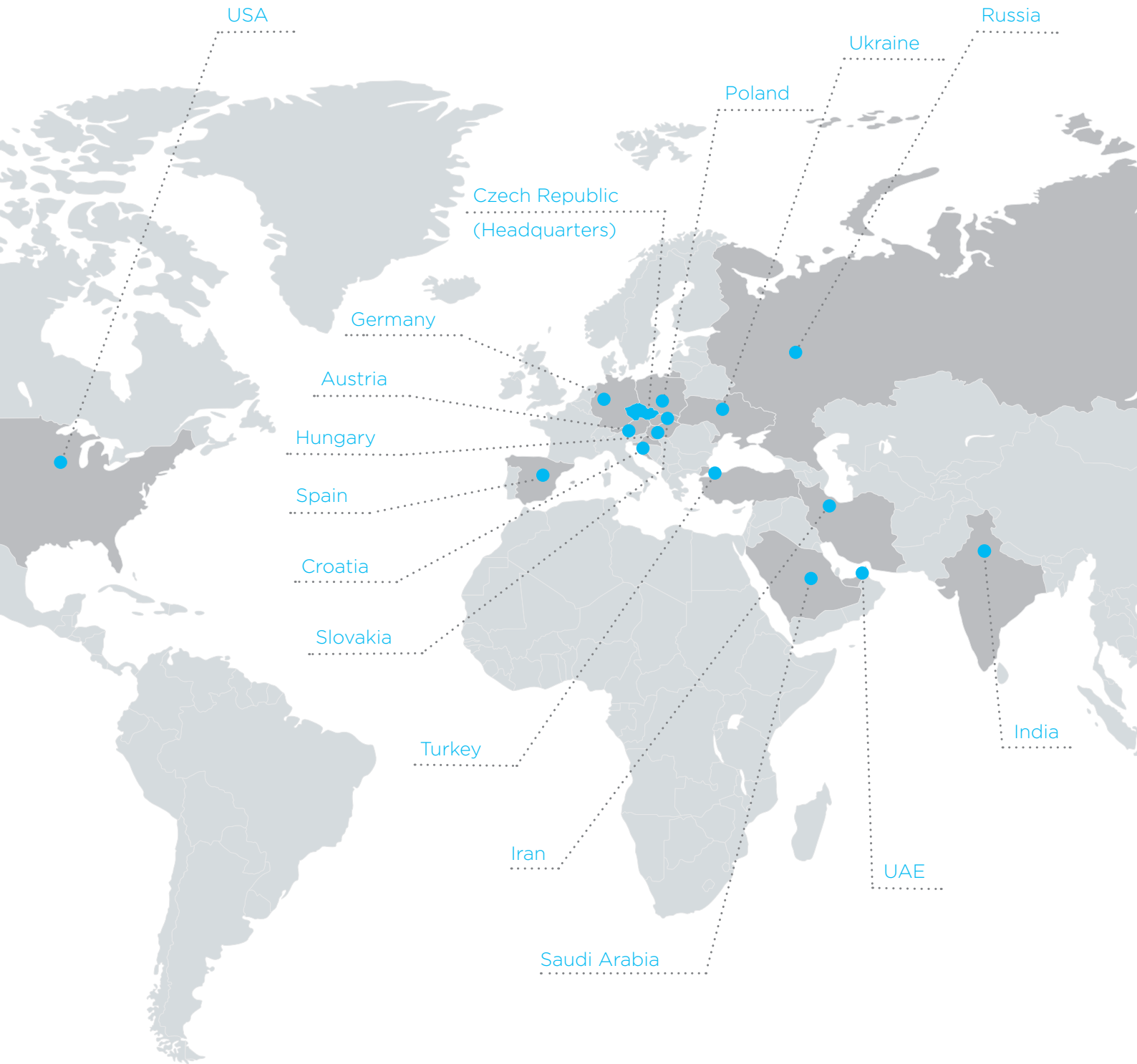

[www.elkoep.com](http://www.elkoep.com)

Published: 1/2018 | 1st edition