



EAN code
 HRH-8/230V: 8595188155427
 HRH-8/24V: 8595188155564
 HRH-8/400V: 8595188171199

- Relay is designed to control the level of conductive liquids in wells, tanks, pools, tankers, reservoirs,... (replacement HRH-1).
- Galvanically isolated supply and guard circuits.
- Within one device, the following configurations can be selected:
 - 2x one-level monitoring (in separate tanks)
 - 1x two-level monitoring (in one tank)
 - pumping from one tank to another.
- DIP switch selection on the front panel (8 functions).
- Adjustable probe sensitivity (for each probe separately).
- Adjustable relay switching delay (for each probe separately).
- 10 Hz watch frequency prevents polarization of the liquid and increases resistance to interference by network frequency.

Technical parameters **HRH-8**

Function:	8
Supply terminals:	A1 - A2
Voltage range:	AC 230 V, AC 400 V or AC/DC 24V galvanically separated (AC 50-60Hz)
Burden max.:	2.5 W/5 VA (AC 230 V, AC 400 V), 1.4 W/2 VA (AC/DC 24 V)
Max. dissipated power (Un + terminals):	4 W (230 V, 400 V); 3 W (24 V)
Supply voltage tolerance:	-15 %; +10 %

Measuring circuit

Hysteresis (input - opening):	in an adjustable range 5 kΩ - 100 kΩ
Voltage on electrode:	max. AC 3.5 V
Current in probes:	AC < 1 mA
Time reaction:	max. 400 ms
Max. cable capacity:	800 nF (sensitivity 5kΩ), 100 nF (sensitivity 100 kΩ)
Time delay t:	adjustable 0.5 - 10 sec

Accuracy

Setting accuracy (mech.):	± 5 %
---------------------------	-------

Output

Number of contacts:	2x changeover/SPDT (AgNi/Silver Alloy)
Current rating:	16 A/AC1; 1 HP 240 Vac, 1/2 HP 120 Vac; PD. B300
Breaking capacity:	4000 VA/AC1, 384 W/DC
Inrush current:	30 A/< 3 s
Switching voltage:	250 V AC/24 V DC
Output indication:	red LED
Mechanical life:	10.000.000 ops.
Electrical life (AC1):	100.000 ops.

Other information

Operating temperature:	-20 .. 55 °C (-4 .. 131 °F)
Storage temperature:	-30 .. 70 °C (-22 .. 158 °F)
Dielectric strength:	4 kV (supply - output)
Operating position:	any
Mounting:	DIN rail EN 60715
Protection degree:	IP40 from front panel/IP20 terminals
Overtoltage category:	III.
Pollution degree:	2
Max. cable size (mm ²):	solid wire max. 1x 2.5 or 2x1.5/with cavern max. 1x 1.5 (AWG 12)
Dimensions:	90 x 52 x 65 mm (3.5" x 2" x 2.6")
Weight:	247 g/8.7 oz (110 V, 230 V, 400 V); 145 g/5.1 oz (24 V)
Standards:	EN 60255-1, EN 60255-26, EN 60255-27, EN 60669-1, EN 60669-2-1
Measuring sensors:	see pg. 132

Measuring probes

There can be any measuring probe (any conductive contact, it is recommended to use brass or stainless steel).
 The probe wire does not need to be shielded, but it is recommended.
 When using a shielded wire, the shielding is connected to terminal S.

Description

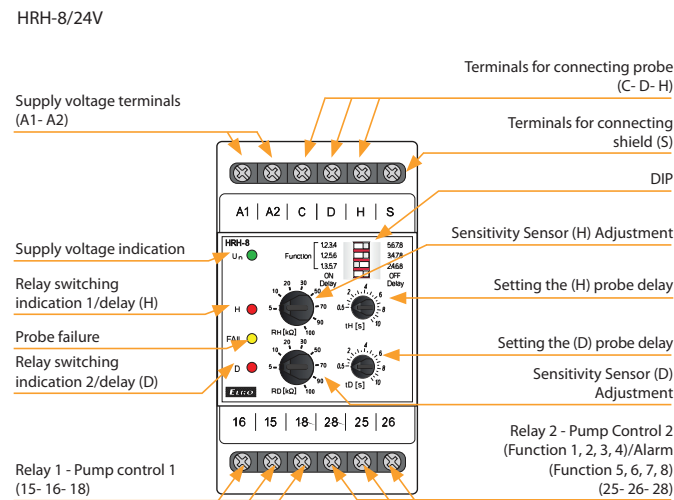

Description and importance of DIP switches

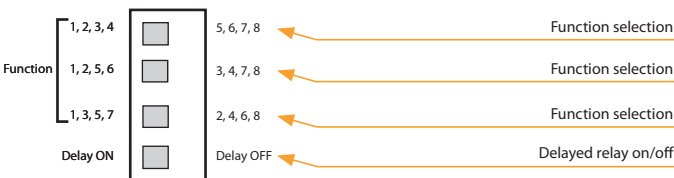

Connection

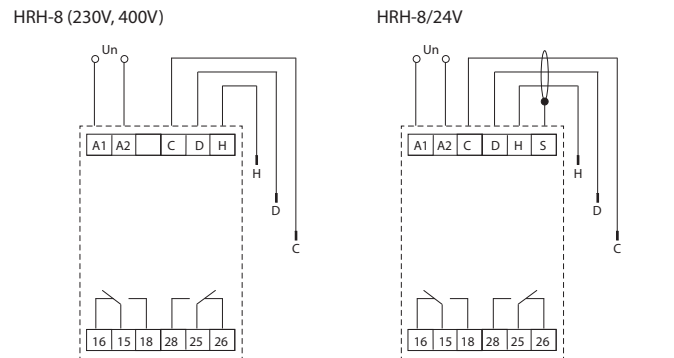

Symbol

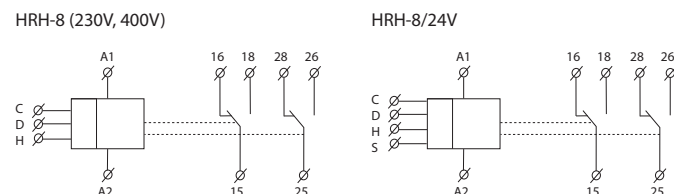

Functions

PUMP UP, ON DELAY (Function 1,3,4)



PUMP DOWN, ON DELAY (Function 2,3,4)

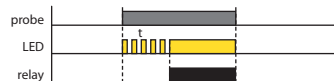

PUMP UP, OFF DELAY (Function 1,3,4)

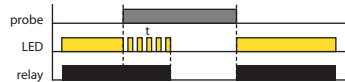

PUMP DOWN, OFF DELAY (Function 2,3,4)



PUMP UP, OFF DELAY (Function 5)

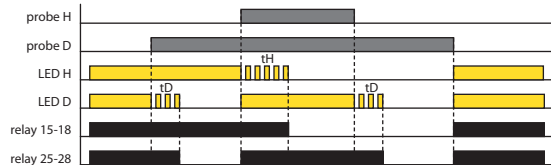

PUMP UP, ON DELAY (Function 5)

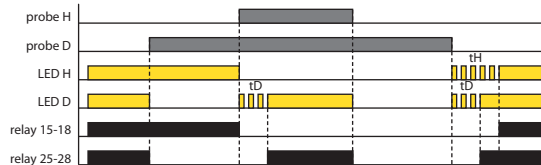

PUMP DOWN, OFF DELAY (Function 6)

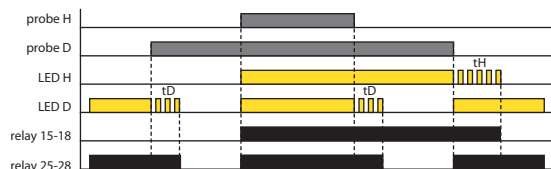

PUMP DOWN, ON DELAY (Function 6)

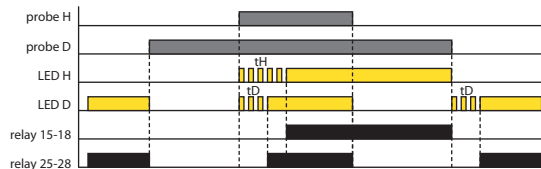

WELL - TANK, OFF DELAY (Function 7)

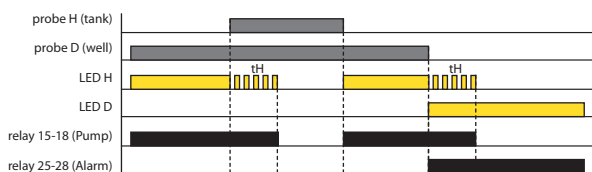

WELL - TANK, ON DELAY (Function 7)

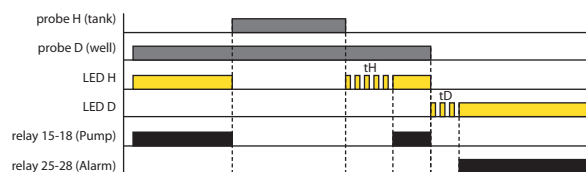

RESERVOIRS - TANK, OFF DELAY (Function 8)

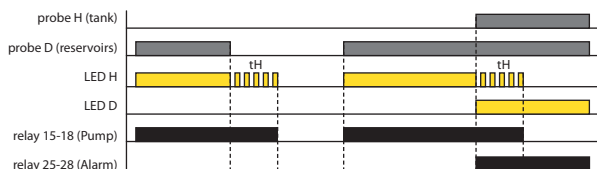

RESERVOIRS - TANK, ON DELAY (Function 8)

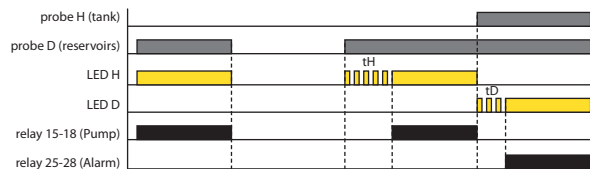

The relay is designed to monitor the level of conductive liquids with a choice of 8 functions:

- 1) - 2 separate tanks (each with 1 probe) - both PUMP UP (filling)
- 2) - 2 separate tanks (each with 1 probe) - both PUMP DOWN (emptying)
- 3) - 2 separate tanks (each with 1 probe) - H PUMP DOWN probe, D PUMP UP probe
- 4) - 2 separate tanks (each with 1 probe) - H PUMP UP probe, probe D PUMP DOWN
- 5) - both probes in one tank - PUMP UP - maintain level between probes H and D (as HRH-5), relay 1 switches on the pump, relay 2 alarm (level is not between probes H and D)
- 6) - Both probes in one tank - PUMP DOWN - maintaining the level between probes H and D (as HRH-5), relay 1 switches on the pump, relay 2 alarm (the level is not between probes H and D)
- 7) - Pumping from the well to the tank - probe D in the well, probe H in the tank. The pump only runs if the probe D is flooded (enough water in the well) and the tank is not full (probe H). The alarm reports a lack of water in the well (probe D is not flooded).
- 8) - Pumping from the sump to the tank - probe D in the sump, probe H in the tank. The pump only runs if the probe D is flooded (full tank) and the tank is not full (probe H). The alarm reports the status of full tank and sump (both probes are flooded).

LED indication:

The red LED lights up - the corresponding relay is switched on
Red LED flashes - delay timing

The yellow LED indicates probe failure - Functions 5, 6 probe H is flooded and probe D is not. At the same time both red LEDs flash.

To prevent polarization and electrolysis of the liquid and undesirable oxidation of the monitoring probes, an AC current of 10 Hz is used for monitoring. The low frequency has a positive effect on suppression of interference by 50 (60) Hz. Three probes are used to monitor the level: H - upper level, D - lower level and C - common probe. In the case of the use of a conductive material tank, it is possible to use the tank itself as a C probe. Probe C can also be connected to the protective conductor of the power supply system (PE). To prevent undesired switching by various influences (soiling of dips, moisture ...), the sensitivity of the device can be set according to the conductivity of the liquid being monitored (corresponding to the "resistance" of the liquid) in the range of 5 to 100 kΩ. To limit the effect of undesired switching of output contacts by raising the liquid level in the tank, it is possible to set the output response delay 0.5 - 10 s.